

AUDIO TEST GEAR YOU CAN BUILD

JUNE 1997

Electronics NOW®

Build an FM

Stereo Transmitter

It's easy to build, yet provides better quality and performance than similar units

Build your own
BEAM Robot

Create simple mechanical creatures that seem to have a life of their own

All About
Boundary Scan Testing

Learn about the new generation of digital ICs that practically test themselves

Flexible Semiconductors

All about a new discovery that could change the shape of technology



A GERNSBACK PUBLICATION

#BXNBQWF***** 5-DIGIT 21046
#DHM9515R093 7#460734 GAP73



ROBERT DAHM
9515 RED RAIN PATH
COLUMBIA MD 21046-2073

APR 99
53EN

\$3.99 U.S.
\$4.50 CAN.

No Other DMM In the World Does This. For This.

ACCURACY

FEATURES

SAFETY

VALUE

50,000
counts

Incredible Resolution for Fast Readings easily visible with 14mm characters in a large backlit LCD. The finest measurements possible in a DMM for quick diagnostics and troubleshooting.

TRMS (AC+DC)

Selectable AC or AC+DC for AC Volts and Current plus all the performance characteristics of a full-function DMM to 100kHz. True RMS assures accurate measurement of non-sinusoidal waveforms.

ZOOM Bargraph gives you a closer, more accurate look at fast changes. Increases resolution by a factor of 5 or 11, depending on model, by simply pressing the "zoom" button.

RS-232 Compatible for The Record

You can record measurements on a PC or printer, or recalibrate the instrument without opening the case, with B+K hardware & software kits (optional). You'll even be able to have full ISO9000 documentation of calibration results.



50,000µF Capacitance measures motor start and run capacitors and most computer grade capacitors. Once again, you can use the same DMM for just about everything.

Power Line Disturbance

indicators tell you if places like offices (single-phase) or industrial plants (three-phase) have a problem. Measures transient voltages >80V, high frequency (1kHz to 100kHz) harmonic disturbance >24V.

Selectable Impedance dB VA

for dB and resistive power measurements is easy. Just tell the meter the impedance and it calculates dB or resistive power automatically. Select from 600Ω, or any value from 1Ω to 9999Ω.



Temperature On Cue

from -200 C to 800 C, with an accuracy to 1 C. Selectable for display in C or F (Model 5370*).

\$289⁰⁰

MODEL 5370 (shown)

New Technology At The Right Price. There just isn't a more accurate, higher resolution, feature-packed DMM like it anywhere. There are more digits of resolution for a lot less digits in price. And, you can even use the 5300 series to check other test instruments. Every meter is supplied with a Statement of Calibration. And, there's nothing safer, because all B+K 5300 Series ASYC II (Advanced Safety Concept) DMMs are designed to stringent safety standards. You'll never have to worry about using it virtually anywhere. The B+K 5300 DMMs are available now at your favorite B+K Distributor.

	Accuracy (DC Volts)	TRMS (AC or AC+DC) on AC Volts & Current	Capacitance to 50,000µF (50 mF)	ZOOM Bargraph Equiv. 170 segment Resolution	Power Line Disturbance Indicator Transient/Harmonic	Relative Mode	dBm	Resistive Power
5390	0.025%	✓	✓	✓	✓	✓	✓	✓
5380	0.025%	✓	✓	✓	✓	✓	✓	
5370	0.05%	✓	✓	✓	✓	✓	✓	
5360	0.1%	✓	✓	✓	✓	✓	✓	

Specifications & Prices subject to change without notice. © B+K Precision, 1997 *Connect to B+K Model TP-5300 Temp Probe

See the complete 5300 Series Specifications on our web site and you'll be convinced. B+K offers industry's largest selection of value-based DMMs, test instruments and accessories. Immediate response via e-mail.

www.bkprecision.com

6470 W. Cortland Street
Chicago, Ill 60707
(773) 889-1448
Fax: (773) 794-9740



CIRCLE 77 ON FREE INFORMATION CARD

CONTENTS

JUNE 1997

ON THE COVER

31 BUILD AN FM STEREO TRANSMITTER

Are you tired of radio stations that play everything except the music you like, or have you ever envisioned yourself as a budding Howard Stern or Rush Limbaugh? If so, here's the perfect vehicle to get you on the air, even if only in a small way. It is an FM-stereo transmitter that offers several advantages over similar units, including better fidelity and sound quality, freedom from frequency drift, and more. Yet, it is easy to build either from scratch or from an available kit. You can also use it to pipe the music to every radio in your home or office, as a wireless FM microphone, and in many other ways.

— William Sheets, K2MQJ and Rudolf F. Graf, KA2CWL



TECHNOLOGY

49 AN INTRODUCTION TO BOUNDARY SCAN TESTING

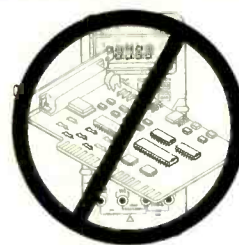

A new standard that makes it easier than ever to test complex digital ICs, even when still in circuit. — J. Daniel Connell

56 BENDING THE FUTURE OF SEMICONDUCTORS



Learn how researchers have put a whole new twist on the shape of semiconductor technology. — Douglas Page

As a service to readers, ELECTRONICS NOW publishes available plans or information relating to newsworthy products, techniques and scientific and technological developments. Because of possible variances in the quality and condition of materials and workmanship used by readers, ELECTRONICS NOW disclaims any responsibility for the safe and proper functioning of reader-built projects based upon or from plans or information published in this magazine.

Since some of the equipment and circuitry in ELECTRONICS NOW may relate to or be covered by U.S. patents, ELECTRONICS NOW disclaims any liability for the infringement of such patents by the making, using, or selling of any such equipment or circuitry, and suggests that anyone interested in such projects consult a patent attorney.

ELECTRONICS NOW, (ISSN 1067-9294) June 1997. Published monthly by Gernsback Publications, Inc., 500 Bi-County Boulevard, Farmingdale, NY 11735-3931. Periodicals Postage paid at Farmingdale, NY and additional mailing offices. Canada Post IPM Agreement No. 334103, authorized at Mississauga, Canada. One-year subscription rate U.S.A. and possessions \$19.97, Canada \$27.79 (includes G.S.T. Canadian Goods and Services Tax, Registration No. R125166280), all other countries \$28.97. All subscription orders payable in U.S.A. funds only, via international postal money order or check drawn on a U.S.A. bank. Single copies \$3.99. © 1997 by Gernsback Publications, Inc. All rights reserved. Printed in U.S.A.

POSTMASTER: Please send address changes to ELECTRONICS NOW, Subscription Dept., Box 55115, Boulder, CO 80328-5115.

A stamped self-address envelope must accompany all submitted manuscripts and/or artwork or photographs if their return is desired should they be rejected. We disclaim any responsibility for the loss or damage of manuscripts and/or artwork or photographs while in our possession or otherwise.

BUILD THIS

44 BUILD YOUR OWN BEAM ROBOT

Design and build a simple mechanical creature that seems to have a life of its own, then enter it in a competition against others of its kind. — *John Iovine*

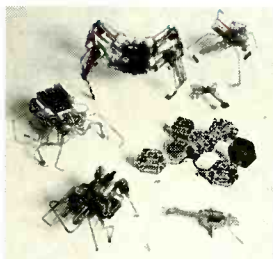

DEPARTMENTS

12 EQUIPMENT REPORT

Tektronix DMM916 true rms multimeter.



22 SERVICE CLINIC

Repairing remote controls. — *Sam Goldwasser*

26 AUDIO UPDATE

Build your own audio test gear. — *Franklin J. Miller*

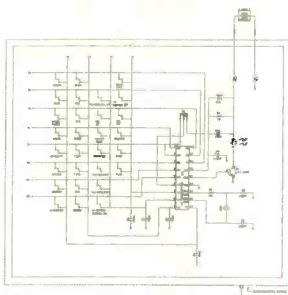

27 COMPUTER CONNECTIONS

Port I/O under Windows 95. — *Jeff Holtzman*

59 TECH MUSINGS

The right way to measure power, a cheap extension lock-out, and more. — *Don Lancaster*

65 LASER EXPERIMENTS

Making two-beam holograms. — *Carl J. Bergquist*

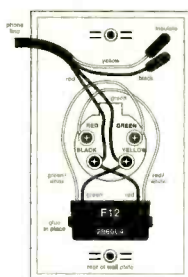

AND MORE

4 EDITORIAL

6 WHAT'S NEWS

8 Q&A

10 LETTERS

14 NEW PRODUCTS

20 NEW LITERATURE

116 ADVERTISING INDEX

116 ADVERTISING SALES OFFICE

Electronics NOW®

Hugo Gernsback (1884-1967) founder

LARRY STECKLER, EHF, CET,
Editor-in-chief and publisher

EDITORIAL DEPARTMENT

CARL LARON, editor
JOSEPH J. SUDA, technical editor
JULIAN S. MARTIN, associate editor
TERI SCADUTO, assistant editor
MICHAEL A. COVINGTON, N4TMI
contributing editor
SAM GOLDWASSER, service editor
JEFFREY K. HOLTZMAN,
computer editor
FRANKLIN J. MILLER,
audio editor
DON LANCASTER,
contributing editor
EVELYN ROSE, editorial assistant

ART DEPARTMENT

ANDRE DUZANT, art director
RUSSELL C. TRUELSON, illustrator

PRODUCTION DEPARTMENT

RUBY M. YEE, production director
KATHRYN R. CAMPBELL,
production assistant
KEN COREN,
desktop production director
LISA BAYNON, desktop production

CIRCULATION DEPARTMENT

THERESA LOMBARDO,
circulation manager
GINA GALLO,
circulation assistant

REPRINT DEPARTMENT

MICHELE TORRILLO,
reprint bookstore

Typography by Mates Graphics

Electronics Now is indexed in *Applied Science & Technology Index*, and *Readers Guide to Periodical Literature*, *Academic Abstracts*, and *Magazine Article Summaries*.

Microfilm & microfiche editions are available. Contact reprint bookstore for details.

Advertising Sales Offices listed on page 116.

Electronics Now Executive and Administrative Offices
1-516-293-3000.

Subscriber Customer Service:
1-800-999-7139.
7:00 AM-6:00 PM Monday-Friday MST

VISIT US ON THE INTERNET AT:
www.gernsback.com



Audit Bureau
of Circulations
Member

Call for your FREE catalog!

Your One Stop Component & Computer Source

Special Prices for Electronics Now Readers. Please mention VIP #6R7!

80C52-Basic Microcontroller

- Custom-masked 80C52 microcontroller with 8K-byte ROM-resident Basic-52 interpreter
- On-chip oscillator and clock circuit
- Operates DC to 12MHz • 256 x 8-bit RAM
- BASIC interpreter in ROM on a single chip
- "Stand alone" software development
- Interrupts can be handled by BASIC or Assembly Language

Part No.	Description	1-9	10-49
125647	CPU 8-bit CMOS	\$19.95	\$17.95

Jameco Powered Project Board

- DC power: +5V @ 1A, variable power 0-15V @ 500mA
- Input power: 120VAC @ 60Hz
- Back panel has ground terminal
- Outputs are short circuit protected
- Solderless breadboard with 2420 tie points
- Breadboard size: 7.4"L x 6.8"W
- Box size: 9.8"L x 8.0"W x 2.6"H
- Weight: 6.8 lbs. • One-year warranty

Part No.	Description	1-4	5-9
136258	Powered breadbrd	\$99.95	\$89.95

PAPALAX Basic Stamps



Basic Stamps are small computers using a variation of Basic, called PBASIC to control execution of many applications. The BS1-IC has 8 I/O lines, while the BS2-IC has 16 I/O lines which can be connected directly to buttons, LEDs, registers, and many other TTL level devices. • One-year warranty

Part No.	Description	Price
127693	Basic stamp BS1-IC	\$34.95
130892	Basic stamp BS2-IC	49.95

BestProto Prototyping Board Stamp Size Prototype Builder (3 pcs.)

- For single chip circuits
- (2) 1206 surface mount bypass capacitor sites, (16) general purpose sites & (2) 0805 sites
- Size: 1.4"L x 0.8"W • Weight: 0.02 lbs.

Part No.	Description	1-4	5-9
136451	3 stamp size boards	\$6.95	\$6.25

LOGICAL CUPL Software

- PLD/FPGA Design Software system
- Designed as a universal program-able logic development system
- Runs either in DOS or in a DOS prompt within Microsoft Windows®

Part No.	Description	Price
132871	CUPL starter kit	\$79.95
132880	PAL expert	Special 179.95

4 1/2-Digit Multimeter

- Measures: AC voltage (2V-700V) DC voltage (200mV-1000V) AC/DC current (2mA-10A) Resistance (200Ω-200MΩ) Frequency (20kHz) Capacitance (2000pf-20μF)
- Measures transistor hfe and continuity
- Size: 8.8"L x 3.9"W x 1.9"H
- Weight: 1.6 lbs. • One-year warranty

Part No.	Description	1-4	5-9
136590	4 1/2-digit meter	\$69.95	\$62.95

Jameco Digital-Analog Lab

- Solderless breadboard
- DC power supplies
- Function generator (5 ranges)
- Variable resistors, data switches, pulse switches, speaker, banana sockets, BNC jacks, and red LEDs
- 2-digits of segment LED display
- Size: 12.8"W x 9.8"D x 3.7"H
- Weight: 9.5 lbs. • One-year warranty

Part No.	Description	Price
136266	Digital-Analog lab	\$329.95

Jameco ABS Speedy Boxes

- Will not crack or split when drilled or punched. PCB mounting slots on all four sides and the lid has a lip for precision fit (adds 0.4" height). Complete with four screws and lid. All sizes below are for interior dimensions. • Black ABS plastic

Part No.	Size (L x W x D)	1-9	10-49	50-99
18921	3.1" x 2.0" x 0.9"	\$2.25	\$1.95	\$1.59
18913	4.9" x 2.5" x 1.5"	2.49	2.25	1.79
18892	6.0" x 3.5" x 1.9"	2.95	2.69	2.39
18905	7.5" x 4.3" x 2.3"	3.49	2.95	2.49

Jameco E(E)PROM Programmer

- Programs 16Kbits to 512Kbits EPROMs
- Programs EPROMs, EEPROMs
- Programming speeds/algorithms: normal, intelligent, and quick pulse

Part No.	Description	1-4	5-9
101400	1 socket 16Kbits-512Kbits E(E)PROM prog.	\$129.95	\$116.95

7 Watt Mono Amplifier Kit

- Music output power: 7W/4Ω
- RMS output: 3.5W/4Ω & 2W/8Ω
- Harmonic distortion: 0.05% (1W/1kHz)
- Frequency response: 20 to 20kHz (-3dB)
- Short circuit/overload protection
- Requires speakers and power supply: 15VDC (8 to 18VDC @ 0.5A)
- Board size: 2.2"L x 1.4"W • Weight: 0.3 lbs.

Part No.	Description	1-4	5-9
127255	7W mono amp. kit	\$12.95	\$11.49

Electronic Temp-Control Soldering Station

- Temperature control: 500°-800°
- Circuit protects voltage and current sensitive ICs from voltage spikes
- Power consumption: 45W at 650°
- Includes one 1/16" tip • UL listed
- Weight: 2.4 lbs. • One-year warranty

Part No.	Description	1-4	5-9
129058	Soldering station	\$69.95	\$62.95

Benchtop PC Board Solder Station

- Holds PC boards up to 13" wide
- Can be adjusted by using press release and sliding support arm to hold desired size board
- Right hand soldering iron holder
- Size: 19.5"W x 8.8"D x 8.8"H

Part No.	Description	Price
133065	PC board solder station	\$29.95

Jameco Solderless Breadboards

- Formed with V-shaped cross-sectional groove, which allows DIP IC pins inserting across two parts and to increase the rate of utilization due to small pitch
- Dovetail protrusions and recesses designed to connect two adjacent tightly together

Part No.	Contact Points	Size L x W	1-9	10-49
136910	960	5.5 x 2.8	SALE \$8.95	
136901	1600	5.5 x 2.3	SALE 19.95	

Jameco 66 Piece Tool Kit

- A comprehensive set of tools for field technicians, engineers and lab personnel. Aluminium case features removable pallets, surface-type locks, a black plastic handle, side buckles and strap.
- Size: 18.0"L x 14.0"W x 6.0"H • Wt: 18.2 lbs.

Part No.	Description	1-4	5-9
105646	66 piece tool kit	\$179.95	\$161.95

Function Generator Kit

- Sine, triangle, and square wave
- Great for prototyping electronic circuits, whether analog or digital!
- Produces sinusoidal, triangular and square wave-forms at frequencies continuously variable from 1Hz to 100kHz. Requires 12VDC supply or ±6VDC split supply.
- Size: 4.1"L x 1.5"W • Wt: 0.2 lbs.

Part No.	Description	Price
20685	Function generator	Special \$17.95

Easy Quad Multimedia Kit

- Quad speed CD-ROM drive has 600KB/sec transfer rate, access speed of less than 235msec and is Kodak Photo CD compatible
- 16-bit sound card supports Sound Blaster Pro, AdLib and Microsoft Windows® Sound System Standards
- 3" 20 watt shielded speakers feature tone/volume controls
- Weight: 5.3 lbs. • One-year warranty

Part No.	Description	Price
132062	4X multimedia kit	\$139.95

Boca Research FaxWorks 14.4 Fax/Data w/ Voice Mail

- Also works as answering machine, voice mailbox and fax machine
- Compatible with DOS, Win® 3.1 and Win® 95
- V.34 and 14.4 Kbps of data
- Weight: 1.2 lbs. • Five-year warranty

Part No.	Description	Price
137998	Int. fax/data/voice	Special \$44.95

Digital Hand-held 5MHz Oscilloscope

- This compact scope is perfect for the technician on-the-go or for students and lab technicians as well! The display is high contrast LCD with wide angle for visibility, and all functions are done from easy to use keypad. • Size: 9.0"L x 4.9"W x 1.5"H
- Weight: 2.4 lbs. • One-year warranty

Part No.	Description	Price
135941	5MHz oscilloscop.	Special \$259.95

PC-MultiLab Card

- The perfect solution for your PC-based engineering I/O needs.
- 8 A/D inputs with 12-bit resolution
- 32 digital I/O, TTL compatible (16 in, 16 out)
- ±5V A/D input range
- 20-point wiring terminal daughterboard
- 25kHz maximum A/D sampling rate
- Weight: 3.0 lbs. • One-year warranty

Part No.	Description	Price
28290	PC-MultiLab card	Special \$279.95

Jameco Electronic Component Cabinet Kits

- Kits include the most popular components with extra space for your customized expansion. Each kit includes a 20 drawer component cabinet.

More kits available - call for details!

Part No.	Description	Price
84953	330 pc. 7400 series IC kit	\$169.95
84961	420 pc. 74LS series IC kit	119.95
84970	300 pc. CD4000 series IC kit	84.95
84988	385 pc. Linear series IC kit	159.95
108329	540 pc. 1/8 watt Resistor kit	29.95
81832	540 pc. 1/4 watt Resistor kit	28.95
107879	540 pc. 1/2 watt Resistor kit	31.95
108433	2200 pc. Electr. Hardware kit	39.95
81867	110 pc. Radial Capacitor kit	34.95
81859	320 pc. Ceramic Capacitor kit	29.95
81883	160 pc. Mylar Capacitor kit	34.95
81841	129 pc. Tantalum Capac. kit	49.95
82587	270 pc. Diode kit	39.95
82595	180 pc. Transistor kit	49.95

JAMECO ELECTRONIC COMPONENTS COMPUTER PRODUCTS
© 1997 Jameco 6/97

1355 Shoreway Road Belmont, CA 94002-4100
FAX: 1-800-237-6948 (Domestic)
FAX: 415-592-2503 (International)
E-mail: info@jameco.com
http://www.jameco.com

Ordering Hours: 5:30am - 5:30pm PST

Call for your FREE catalog!

Call 1-800-831-4242 to order today!

Special V.I.P. # 6R7

Whatever
you're
looking for...
look to NTE!

ELECTRONIC
CAD SOFTWARE

NEW!
Windows 95, 3.11, 3.11
and NT Compatible

These software programs make printed circuit-board engineering and design easier and more affordable than ever.



WinDraft® schematic design helps engineers:

- generate schematic designs within minutes of installation
- wire, draw, print, and finish the design

WinBoard™ PCB layout software provides:

- all the power necessary to accommodate complex board designs
- the tools to maneuver high-speed circuits, analog designs, and dense SMT boards
- a library of over 700 module footprints (including over 350 SMT footprints)



Now you can cross-reference over 250,000 semiconductors to NTE.



Cross-reference over +1,000 relays to NTE.

Call for QUICKCross™,
the handy cross-referencing tool for
all NTE replacement parts.

1 (800) 683-6837

www.nteinc.com



NTE ELECTRONICS, INC.

ACTION, NOT EMPTY PROMISES

CIRCLE 71 ON FREE INFORMATION CARD

EDITORIAL

Meet Sam Goldwasser

Long time readers of this magazine and its predecessor, **Radio-Electronics**, are almost sure to remember Jack Darr. From 1952 until age and illness forced him to give up his duties as Service Editor in the late 1980s, Jack reigned supreme as the king of the electronics service technicians. Countless individuals, and even many servicing professionals, would turn to him when all else failed.

While no one could ever replace Jack, we feel that we've finally found someone to fill his niche with this magazine. That person is Sam Goldwasser, and if you have spent some time frequenting the Internet, his work may be quite familiar to you.

Sam is a regular contributor to the sci.electronics.repair Usenet newsgroup. Even more important, he is the author of the highly popular and useful sci.electronics.repair FAQ. That FAQ (Frequently Asked Questions) list is, in fact, one of the most comprehensive and user-friendly sources for practical electronics repair and troubleshooting information on the Internet.

Aware that the typical hobbyist might not have access to a technical-tips database like those used by professionals, the FAQ was developed using a troubleshooting approach. That means that instead of a "if you see A, B is the likely cause" type of presentation, the reader/troubleshooter is taken through a logical process to pin-point the cause of a malfunction, and what to do to fix it. Sprinkle in a little humor, add some common-sense advice, and you've got the kind of mix of good reading and useful pointers that's sure to be helpful to both the hobbyist and the service professional.

Again, if you've seen Sam's work on the Internet, you know what I'm talking about. If not, you are in for a treat. Sam's first column, on servicing remote controls, appears on page 22. Future installments will cover the complete range of servicing topics, including microwave ovens, computer monitors, TV sets, VCRs, and much, much more.

Carl Laron
Editor

Your Ultimate Source!

**For Quality Electronic Components
Internet Access...**

- 24 hours-a-day, 7 days-a-week!
- Online ordering & stock status!
- Fast, efficient parts search!
- No minimum order!



Same-Day Shipment!
on orders entered by 5:00pm central (M-F)



Digi-Key®

www.digikey.com/us

CIRCLE 133 ON FREE INFORMATION CARD

www.americanradiohistory.com



WHAT'S NEWS

A REVIEW OF THE LATEST HAPPENINGS IN ELECTRONICS

Electricity and the Heart

A New Mexico State University electrical engineering professor has received a \$70,000 grant from the American Heart Association to study the electrical nature of the heart in the hopes of improving the use of electrical shock to revive hearts that have stopped beating. Using thousands of complex calculations and computer simulations, Kwong Ng is able to address two important medical questions. When electrical currents are applied to bring back a normal heart beat, where should the electrodes be placed? And how can physicians tailor the application, or the defibrillator, from person to person to optimize its effect?

"It is conceivable that when we get everything developed, there can be a defibrillator designed for each patient," said Ng, a researcher in biomedical engineering.

It makes sense that an electrical engineer would contribute to the study of the heart, which depends upon electrical stimulus. The hearts has a natural pacemaker in the form of cells that emit regular electrical impulses. Those impulses allow the heart muscle to be automated. In the course of a human life, the heart beats more than two-and-a-half billion times without ever pausing to rest.

When the heart stops beating, medical personnel might apply high-voltage electrodes to stimulate it back into action. Success often depends on the current—its strength and where it moves inside the chest cavity, or thorax. Even the size of the electrode can affect the success of the procedure.

Ng's research team can see how the electrical current is moving inside the thorax by simulating the cardiac massage procedure on computer. The computer modeling requires constructing precise shapes of tissues and organs, including the heart. The research currently uses image data from animals.

After developing the model, the team will apply a theoretical voltage from a

theoretical electrode. The engineers will run thousands of computer trials, changing the amounts of electricity, placement of electrodes, and size of electrodes to see how those variables affect the procedure's success. Because of the complexity of its numerical method experiments, the group uses parallel supercomputers to calculate the results. "There can be 1000 to 5000 configurations, and each requires us to solve a complicated mathematical problem," explained Ng.

Ng's study, which began in 1990, has also received funding from the National Institutes of Health.

Super-Fast 21st Century Internet?

According to NASA engineers, by 2002, information could flow a million times faster than today's home computer modems allow, and 1000 times faster than a current T1 business computer line, thanks to research and development by NASA and five other federal agencies on the Next Generation Internet (NGI) initiative. Other agencies involved in the three-year, \$300-million federal project to develop the NGI are the National Science Foundation, the Defense Advanced Research Projects Agency, the Department of Energy, the National Institutes of Health, and the National Institute of Standards and Technology.

President Clinton endorsed the NGI concept in his State of the Union address earlier this year, saying, "We must endorse the second generation of the Internet so that our leading universities and national laboratories can communicate at speeds 1000 times faster than today, to develop new medical treatments, new sources of energy, new ways of working together."

NASA's portion of the R&D work will be conducted at its Ames Research Center, in Mountain View, California.

Christine Falsetti, NGI project manager at Ames, said, "We want to guarantee levels of service that will eliminate slow-downs and network stagnation that users sometimes have to endure now while waiting for Internet images, movies, and other services."

The goal of the six agencies is to interconnect "core sites" with high-speed lines late this year, and then connect to "GigaPOPs" across the country. "A 'GigaPOP' is a regional group of core organizations that will connect their separate computer network systems by high-speed communications lines," Falsetti explained. "A 'POP' is a 'point of presence,' and 'Giga' stands for a billion [computer bits]."

An example of a GigaPOP in the greater San Francisco Bay Area would be the high-speed linking of Ames, Lawrence Livermore Laboratory, the University of California San Francisco, and Stanford University.

"The federal government is going to hook up about 100 universities, research labs, and other institutions at a hundred times the speed of today. NASA now has five research sites connected at 155 megabits (155,000,000 bits per second)," said NASA program manager Bill Feiereisen. Those sites include Ames, Goddard Space Flight Center (Greenbelt, MD), Langley Research Center (Hampton, VA), Lewis Research Center (Cleveland, OH), and the Jet Propulsion Laboratory (Pasadena, CA). "We plan to soon convert them from a speed of 155 megabits to 622 megabits," Feiereisen added.

GigaPOP interconnects are expected to improve over time so that they can transmit computer data at ever faster rates. That means that consumers might be able to see high-quality video programs "on demand" and use the Internet for high-quality teleconferences. The faster rates might eventually allow your local doctor to be able to consult with specialists around the world.

continued on page 24

What's better than speed reading? *Speed Learning.*

Speed Learning has replaced speed reading. It's a whole new way to read and learn. It's easy to learn...lasts a lifetime... applies to everything you read. It may be the most productive course you've ever taken.

Do you have too much to read and too little time to read it? Do you mentally pronounce each word as you read? Do you frequently have to go back and reread words, or whole paragraphs, you just finished reading? Do you have trouble concentrating? Do you quickly forget most of what you read?

If you answer "Yes" to any of these questions — then here at last is the practical help you've been waiting for. Whether you read for business or pleasure, school or college, you will build exceptional skills from this major breakthrough in effective reading, created by Dr. Russell Stauffer at the University of Delaware.

**Not just "speed reading" — but
speed reading — thinking —
understanding — remembering —
and — learning**

The new *Speed Learning Program* shows you, step-by-proven step, how to increase your reading skill and speed, so you understand more, remember more and use more of everything you read. The typical remark from over one million people taking the *Speed Learning* program is, "Why didn't someone teach me this a long time ago." They were no longer held back by their lack of skills and poor reading habits. They could read almost as fast as they could think.

What makes Speed Learning so successful?

The new *Speed Learning Program* does not offer you a rehash of the usual eye-exercises, timing devices, and costly gadgets you've probably heard about in connection with speed reading courses, or even tried and found ineffective.

In just a few spare minutes a day of easy reading and exciting listening, you discover an entirely new way to read and think — a radical departure from anything you have ever seen or heard about. *Speed Learning* is the largest selling self-study reading program in the world. Successful with Fortune 500 corporations, colleges, government agencies and accredited by 18 professional societies. Research shows that reading is 95% *thinking* and only 5% eye movement. Yet most of today's speed reading programs spend their time teaching you rapid eye movement (5% of the problem), and ignore the most important part, (95%) *thinking*. In brief, *Speed Learning gives you what speed reading can't*.

Imagine the new freedom you'll have when you learn how to dash through all types of reading material at least twice as fast as you do now, and with greater comprehension. Think of being able to get on top of the avalanche of newspapers, magazines and correspondence you have to read...finishing a stimulating book and retaining facts and details



FOR FASTER SHIPMENT CALL 1-800-729-7323 OR FAX 1-609-273-7766

more clearly, and with greater accuracy, than ever before.

Listen — and learn — at your own pace

This is a practical, easy-to-learn program that will work for you — no matter how slow a reader you think you are now. The *Speed Learning Program* is scientifically planned to get you started quickly...to help you in spare minutes a day. It brings you a "teacher-on-cassettes" who guides you, instructs, and encourages, explaining material as you read. Interesting items taken from *Time Magazine*, *Business Week*, *Wall Street Journal*, *Money*, *Reader's Digest*, *N.Y. Times* and many others, make the program stimulating, easy and fun...and so much more effective.

Executives, students, professional people, men and women in all walks of life from 15 to 70 have benefitted from this program. *Speed Learning* is a fully accredited course...costing only 1/4 the price of less effective speed reading classroom courses. Now you can examine the same easy, practical and proven methods at home...in your spare time...without risking a penny.

Examine Speed Learning RISK FREE for 15 days

You will be thrilled at how quickly this program will begin to develop new thinking and reading skills. After listening to just one cassette and reading the preface, you will quickly see how you can achieve increases in both the speed at which you read, and in the amount you understand and remember.

You must be delighted with what you see, or you pay nothing. Examine this remark-

able program for 15 days. If, at the end of that time you are not convinced that you would like to master *Speed Learning*, simply return the program for a prompt refund. (See the coupon for low price and convenient credit terms.)

RISK-FREE ORDER FORM

YES! I want to try *Speed Learning* for 15 days without risk. Enclosed is the first of 4 monthly payments of \$32.25*. If I'm not completely satisfied, I may return it for a prompt refund.

SAVE 8.00! I prefer to pay the \$129.00 now, and save the \$8.00 shipping & handling charge. I may still return the program for a full refund.

Method of payment: (Federal Tax Deductible)
 Check or money order payable to Learn Incorporated

Charge to: Visa MC Am Ex Discover

Card # _____ Exp. _____

Signature _____

Phone (____) _____

Name _____

Address _____

City _____ State _____ Zip _____

*Plus \$8.00 shipping and handling. U.S. funds only. For New Jersey residents, sales tax will be added.

learn Dept. LEC-01, 113 Gaither Drive,
INCORPORATED Mt. Laurel, NJ 08054-9987



Q & A

READERS' QUESTIONS, EDITORS' ANSWERS

Measuring Impedance

Q I need an add-on device to use with my DMM to find out the impedance of speakers, microphones, and the input and output of amplifiers with test frequencies of 400 Hz and 1 kHz. — C. K. S., Waymart, PA.

A Measuring the impedance of a speaker or an amplifier input is easy. Just apply a signal through a known resistance and compare the AC voltages across the resistor and across the device under test. As shown in Fig. 1, call these V_R and V_Z respectively, and call the resistor R . Then calculate:

$$\text{Impedance} = R(V_Z / V_R)$$

For best results, the resistor should be roughly comparable in value to the expected impedance; for example, use 10,000 ohms for amplifier inputs, and 10 ohms for speakers. If the resistor exactly matches the impedance, the two voltages will be equal. An advantage of this circuit is that the impedance of the signal generator, regardless of its value, doesn't affect the results.

This technique will reveal peaks and dips in the response of a speaker. For example, we found that an 8-ohm speaker had a true impedance of 14.4 ohms at 1 kHz but only 5.6 ohms at 400 Hz. You can also find out whether the input impedance of an amplifier is the same at all frequencies and all settings of the volume control.

Output impedance is seldom measured because the output impedance of a device is not the same as the impedance that the device is designed to drive. For example, an amplifier that drives an 8-ohm speaker may have a true output impedance of 0.1 ohm or less.

To measure the output impedance of any signal source, use it to drive two loads of different resistances, as shown in Fig. 2, and compare the voltages.

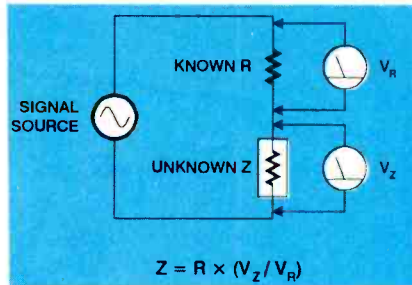

FIG. 1—HERE'S HOW TO MEASURE the impedance of any device driven by a signal generator.

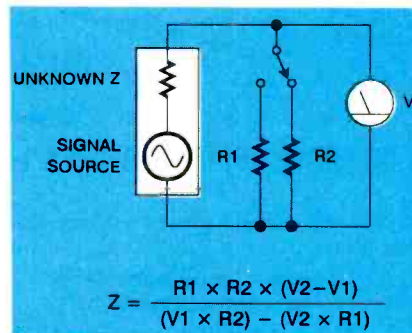

FIG. 2—TO MEASURE OUTPUT IMPEDANCE, use the same signal source to drive two loads with different impedances, then perform the calculation.

Then calculate:

$$\text{Impedance} = (R1 \times R2 \times (V2 - V1)) / ((V1 \times R2) - (V2 \times R1))$$

Here V_1 and V_2 are the voltages with loads R_1 and R_2 respectively. Naturally, both of the loads should be within the range that the signal source is designed to drive, such as 8- and 16-ohm resistors across the speaker terminals of an amplifier.

Measuring the output impedance of a microphone is harder because the signal levels are too low for a DMM to display. You could use the circuit of Fig. 2 with a high-impedance-input amplifier ahead of the DMM. As a quick check, try putting a 1000-ohm resistor across the output of the microphone. If the signal level drops only slightly, you have a 600-

ohm microphone. If the signal drops substantially or disappears, the microphone impedance is much higher.

Charging Big Batteries

Q I have a 1971 Datsun that I've converted into an electric vehicle powered by eight 12-volt batteries in series, totaling about 100-volts DC. I charge them through a Variac and a bridge rectifier. When the batteries are partly discharged, they offer minimal resistance and draw too much current from the charging circuit. Is there some way of eliminating the manually adjusted transformer and limiting the charging current to 20 amps when the battery voltage is low? — H. E. F., Cape Girardeau, MO

A The Variac and bridge rectifier are essentially a constant-current float charger, which is a good circuit for this purpose. To limit current, we suggest an old trick that works well: a light bulb in series with the batteries. The resistance of a light bulb is nearly zero when cold, so the float-charge voltage on fully charged batteries will be exactly what you intend. When the battery voltage is low, the light bulb will glow dimly, warm up, and limit the current.

To charge your gigantic battery pack, you need a rather big light bulb, or rather a bank of them. Try ten or fifteen 150-watt, 120-volt bulbs in parallel. If the charging current is too low, add more bulbs. Although it sounds low-tech, the bulbs do a good job and will last a very long time, since they never light up to full brightness in normal use. They're cheap, too.

Fuel Gauge Reversal

Q I am installing an aftermarket fuel gauge in my Chevy Cavalier. The new gauge expects the sending-unit resistance to be about 10 ohms with a full tank and 65 to

EARN YOUR B.S. DEGREE IN COMPUTERS OR ELECTRONICS



By Studying at Home

Grantham College of Engineering, now in our 47th year, is highly experienced in "distance education" – teaching by correspondence – through printed materials, computer materials, fax, modem, and phone.

No commuting to class. Study at your own pace, while continuing on your present job. Learn from easy-to-understand but complete and thorough lesson materials, with additional help from our instructors.

Grantham offers three separate distance-education programs, leading to the following accredited degrees:

(1) The B.S.E.T. with Major Emphasis in Electronics. (2) The B.S.E.T. with Major Emphasis in Computers. (3) The B.S.C.S. – the Bachelor of Science in Computer Science.

The B.S.E.T. programs now include Electronics Workbench Professional 5.0.

An important part of being prepared to *move up* is holding the right college degree, and the absolutely necessary part is knowing your field. Grantham can help you both ways – to learn more and to earn your degree in the process.

Write or phone for our free catalog. Toll free, 1-800-955-2527, or see mailing address below.

Accredited by
the Accrediting Commission of the
Distance Education and
Training Council

GRANTHAM
College of Engineering
Grantham College Road
Slidell, LA 70460

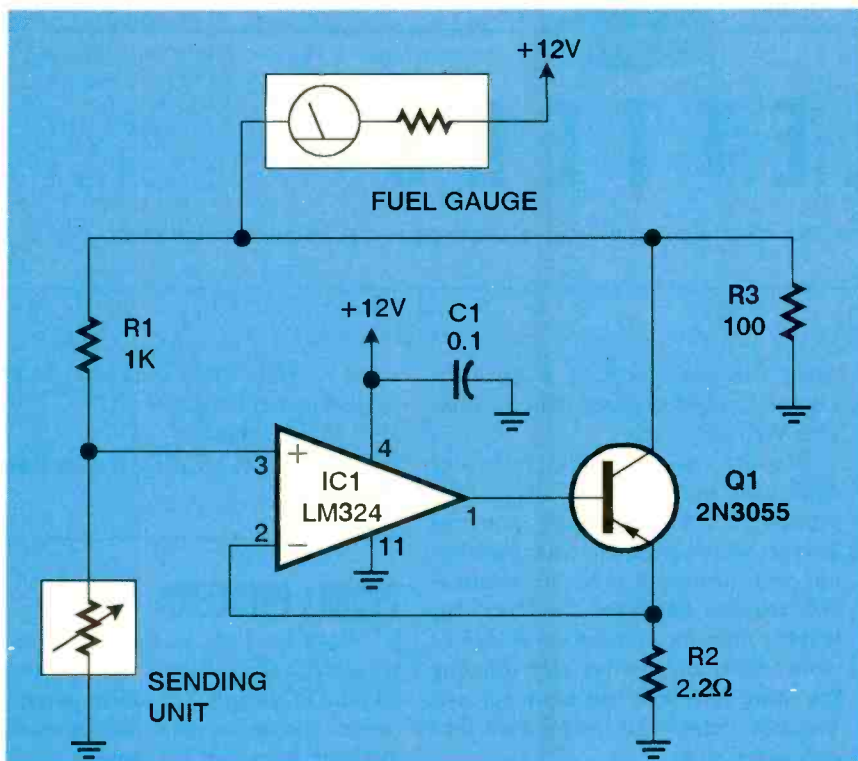

FIG. 3—IF OTHER METHODS FAIL, use this circuit to reverse the polarity of the signal from the fuel sender. While the end points will be fine, linearity will be somewhat off.

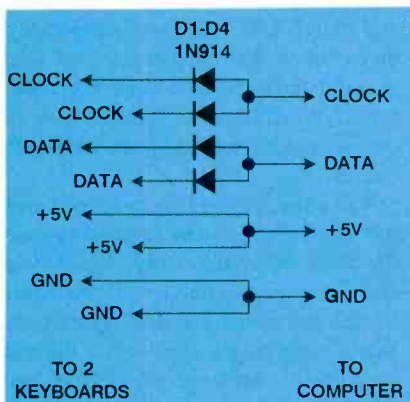

FIG. 4—WHILE KEYS THAT USE BI-DIRECTIONAL communications will not work, this simple circuit lets you interface two keyboards to a PC.

95 ohms with an empty tank. The factory sending unit is just the opposite, 90-ohms full and 0-ohms empty. Is it possible to convert the factory fuel sender from its original resistance to values that will work with the new gauge? — A. F., Cherry Hill, NJ

A First, see if you can rewire the meter so its needle swings in the opposite direction, or rewire the sending unit so the resistance is measured from the other end of the wiper.

If not, Fig. 3 shows a circuit you can try. The higher the resistance of the sending unit, the more Q1 conducts, so higher resistances appear to be lower

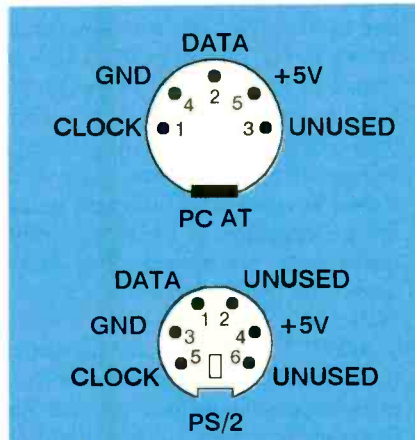

FIG. 5—HERE ARE THE CONNECTOR PINOUTS for the two styles of PC keyboards. Leave unused pins unconnected, and note the unusual pin numbering.

from the gauge's point of view. Note that the ends of the scale will be in the right places, but the linearity in between won't be perfect; the halfway mark won't necessarily indicate that the tank is half full. But then, the linearity probably wasn't very good in the first place. You may have to adjust R1, R2, and R3 to get reasonable results.

Because R1 and the sending unit are fed from the voltage coming from the fuel gauge, the circuit accurately simulates a resistive load. Use an LM324 so

continued on page 68



LETTERS

SEND YOUR COMMENTS TO THE EDITORS OF ELECTRONICS NOW MAGAZINE

GUARDIAN CORRECTIONS

I noticed some errors in my article "Build the Guardian" (*Electronics Now*, March 1997). First, in Fig. 1, the drain and source identification of Q1 are reversed. Second, in Fig. 4, the connections shown as "to receiver board data" and "to receiver board ground" are reversed. Finally, in Fig. 2, C23 should connect from pin 3 of IC6 to ground; not to pin 12 as shown. The printed-circuit board layout is correct.

ANTHONY CARISTI

READER HELP READER

I am looking for the service manual and/or the schematics for a Javelin video camera model JE3040CC. I will gladly play the costs for photocopying and shipping. Thank you in advance to anyone that can help.

ROBERT H. PFEIL
935 Kintyre Way
Sunnyvale, CA 94087
E-mail: rpfeil@svpal.org

SORRY, WRONG NUMBER!

We inadvertently printed the incorrect phone number for MCM Electronics in the March 1997 "New Literature" column. MCM's correct phone number is 1-800-543-4330. We apologize for any inconvenience that might have been caused.—Editor

FASTER WEB SITE

Without detracting from the Walnut Creek Web site with its 150-MHz Pentium and excellent archive ("Speeding Up World's Fastest Web Site," "What's News," *Electronics Now*, October 1996), I would like to point out that the DECUS DFWLUG Web site runs on a 175-MHz DEC Alpha, which,

while also impressive, is eclipsed by Digital Equipment Corporation's Altavista Web site.

Altavista runs on a DEC Turbolaser 8400 with six 400-MHz Alpha 21164 processors and is the most powerful Internet search engine to date, performing over 12-million complete information requests (including files) per day, keeping approximately the last 30 days of news online, and continuously scanning the entire Internet about every 10 days. You can connect at <http://www.altavista.digital.com>.

The Alpha processor is a 64-bit chip, executing four instructions per clock cycle, or 1.6-billion instructions per second at 400 MHz. The complete system, known as the Turbolaser 8400, may use from 1 to 12 processors, 14 gigabytes of main memory, and up to 150 terabytes (one terabyte is a million megabytes) of storage. If that is not enough, you can cluster as many as 213 of these systems for performance of over four-trillion instructions per second. The 2000th Turbolaser 8400 was recently shipped to Netscape

DECUS, or Digital Equipment Computer User Society, is a worldwide organization of information system professionals interested in information/software exchange and the advancement of the computing art.

You can connect to the DECUS DFWLUG Web site at <http://Montagar.com/dfwlug/>, or telnet to our BBS (a

small 72-MHz VAX) at 204.181.44.250 or dfwlug.decus.org.

PAT JANKOWIAK
Editor, DECUS DFWLUG Newsletter
Dallas, TX

PCDRILL PROBLEMS

When I set out to design a project, my aim has always been to have plenty of kits and PC boards on hand for potential orders, and to use parts that are readily available from multiple sources for the longest period of time.

Unfortunately, when it came to the "PCDrill" (*Electronics Now*, February and March 1997), circumstances ganged up to foil my best intentions. First of all, demand far out-paced even my wildest expectations. Because of that, I have run out of stock of the caddy kits and the PC boards.

However, an even more serious problem has arisen. In the interval between the time when the article was written and when it was published, the source for the recommended drill (Jameco) has begun supplying a unit with a different form factor. Although the difference is relatively slight, it was enough that the drill caddy might not work correctly in some situations.

As a result, I have completed a re-design of the unit and the PC board. The good news is that the re-design is mechanically easier to build, is more tolerant of minor variations in the drill form factor, and provides better results.

For those interested, the re-design information is available directly from me. Just send a self-addressed, stamped envelope (with 98-cents postage) to the address noted below.

Again, I apologize for any inconvenience that might have been caused by this situation.

J. J. BARBARELLO
817 Tennant Road
Manalapan, NJ 07726

Write To:

Letters,
Electronics Now Magazine,
500 Bi-County Blvd.,
Farmingdale, NY 11735

Due to the volume of mail we receive, not all letters can be answered personally. All letters are subject to editing for clarity and length.

The power to speed through your work.

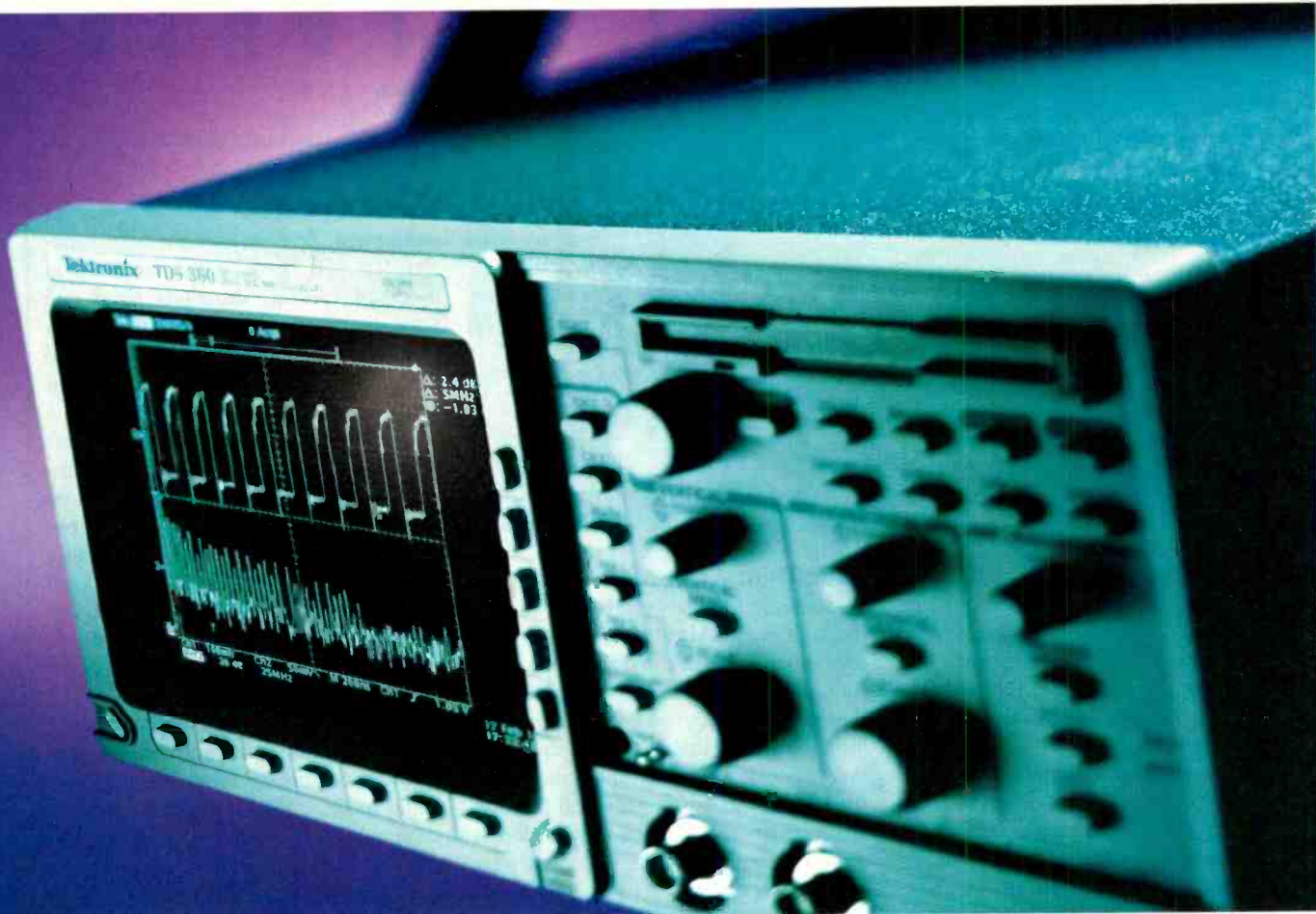

The time-saving scope.

The fast sampling technology of the TDS360 Digital Real-Time oscilloscope gives you the highest level performance in a 200 MHz scope. With a standard built-in disk drive and FFT, the TDS360 oscilloscope lets you speed through your work.

Save yourself time. Contact your Tektronix distributor or call 1-800-479-4490, action code 321, or visit us at www.tek.com

If you probe signals greater than 300 VRMS, you should be using the right probe.

Free probe worth \$199.*

Simply buy the TDS360 by July 31, 1997, and Tektronix will give you a P5100 passive 100x probe free. Call your local distributor for details. *Suggested retail price, USD.

Tektronix



EQUIPMENT REPORTS

TEKTRONIX DMM916 TRUE RMS MULTIMETER

The next multimeter you buy should be the last one you'll ever need.

CIRCLE 15 ON FREE INFORMATION CARD



there's no need for another piece of equipment. A measurement-hold function lets you "grab" a measurement in awkward viewing situations or if you want to record the measurement in a notebook. A 1-millisecond peak-hold function catches transients that might otherwise be missed.

So we don't leave anything out, let's briefly run down the complete list of features before we get into more detail on some of the more interesting features. The meter has a 40,000-count display along with a bargraph that features centering and zooming. It measures AC and DC voltage, AC + DC (RMS) voltage, AC and DC current, resistance, frequency, diodes and capacitors, continuity, duty factor, temperature, and decibels. It can record minimum, maximum, and average values, with time stamping. There's also a delta mode, "Hi/Lo" limits, memory store and recall, automatic fuse verification, and a warning when the leads are connected improperly. All functions have an indicator on the display.

Now for some of the details. The DMM916's display has two modes to display either 4³/₄ or 3³/₄ digits, and either 40,000 or 4,000 counts. The display is updated one time per second in the 40,000-count mode and four times per second in the 4,000-count mode. A 40-segment bargraph is updated 20 times per second for needle-like metering that used to only be available on old-type analog units. Its maximum input voltage is 1000 volts AC or DC. It's accurate to ± 0.06 volt. The maximum current input is 400 milliamps at the microamp/milliamper terminal and 10 amps continuous or 20 amps for 30 seconds at the amp terminal. Both terminals are fused for protection. The meter can measure resistance up to 40 megohms, capacitance up to 400 microfarads, frequency up to 2 megahertz, and temperature from -50 to 980 degrees C with the optional temperature probe.

The controls are sensibly laid out and
continued on page 25

Without a doubt, the most basic, and most useful piece of test gear anyone involved with electronics could own is a DMM. In fact, since you are reading this magazine, the odds are pretty good that you own at least one, and perhaps several.

However, it is important to note that not all DMMs are created equal. While a basic, bare-bones unit might be fine for the occasional tinkerer, if your needs are more demanding, you need to demand a meter that does more. Further, when you finally decide to upgrade to a DMM that offers real high-end features, you should select it as if it was to be the last one you'll ever need. It should have enough features to last a lifetime, and be rugged enough to go the distance.

That may sound like a tall order, and an expensive one, but it does not have to be. Tektronix (PO Box 500, Beaverton, OR 97077; <http://www.tek.com/measurement>), well known as a manufacturer of top-quality test equipment, especially oscilloscopes, makes some of the best, most advanced, and most accurate DMMs around, and, considering their capabilities, sells them for extremely reasonable prices. Take, for example, their DMM910 Series. Prices for these instruments are \$199 for the DMM 912, \$249 for the DMM 914, and \$299 for the "Granddaddy" of the series, the DMM916, which is the unit we actually tested for this review. All three of these multimeters come with a three-year warranty.

Little Things Count

Some multimeters can be awkward to use, but the DMM916 is loaded with convenience features that make it a pleasure, and if you've spent any amount of time with test gear, you know that it is the little things that make a real difference in everyday use. For example, the unit's rotary function switch has an off position on both sides. That not only makes it more convenient to use, but saves wear and tear on the switch itself. The meter comes cradled in a rubber holster with a built-in stand that also has provisions for hanging the unit from a convenient nail, hook, etc. The unit also sports a lighted display so you don't have to point a flashlight at it in dimly lit conditions.

The DMM916 is not a small multimeter, nor is it light in weight. Out of its holster it measures about 7¹/₄ by 3³/₈ by 1¹/₄ inches. It weighs 13 ounces including the 9-volt battery (and 21.2 ounces including the holster). As you might guess from its heft, it is very ruggedly built and is category III certified to 600 volts AC.

Features

As mentioned, the DMM916 is loaded with features that add function and convenience. For example, the dual display lets you see two measurements at once—for example, the amplitude and frequency of a current or voltage—without switching between displays. The meter allows temperature testing with an optional temperature probe, so

Budget Project and Computer Books

BP317—Practical Electronic Timing \$6.95. Time measurement projects are among the most constructed gadgets by hobbyists. This book provides the theory and backs it with a wide range of practical construction projects. Each project has how-it-works theory and how to check it for correct operation.

BP415—Using Netscape on the Internet \$7.95. Get with the Internet and with surfing, or browsing, the World Wide Web, and with the Netscape Navigator in particular. The book explains: The Internet and how the World Wide Web fits into the general scenario; how do you go about getting an Internet connection of your own; how to download and install the various versions of Netscape browsing software that are available; and how to use Netscape Navigator to surf the Web, and to find and maintain lists of useful sites. There's a heck of a lot more, too!

BP325—A Concise User's Guide to Windows 3.1 \$7.95. Now you can manage Microsoft's Windows with confidence. Understand what hardware specification you need to run Windows 3.1 successfully, and how to install, customize, fine-tune and optimize your system. Then you'll get into understanding the Program Manager, File Manager and Print Manager. Next follows tips on the word processor, plus how to use Paintbrush. There's more on the Cardfile database with its auto-dial feature, Windows Calendar, Terminal, Notepad, etc.

BP327—DOS: One Step at a Time \$5.95. Although you spend most of your time working with a word processor, spreadsheet or database, and are probably quite happy using its file management facilities, there will be times when you absolutely need to use DOS to carry out 'house-keeping' functions. The book starts with an overview of DOS, and later chapters cover the commands for handling disks, directories and files.

PCP119—Electronic Music and Midi Projects \$14.95. Save cash by building the MIDI gadgets you need. Want a MIDI THRU box, program change pedal, Metronome, analog echo unit, MIDI patchbay or switcher? Over 16 practical and very useful music and MIDI projects—all in this book! The projects are explained in detail with full instructions on assembly.

PCP120—Multimedia on the PC! \$14.95. What is Multimedia? What can it do for you? It can do lots of nice things! This 184-page book helps you create your own multimedia presentation. Multimedia applications by people like you can revolutionize educational and business applications as well bring more fun, fun, fun into your leisure computer activities.

BP404—How To Create Pages for the Web Using HTML \$6.95. Companies around the world, as well as PC users, are fast becoming aware of the World Wide Web as a means of publishing information over the Internet. HTML is the language used to create documents for Web browsers such as Mosaic, Net-scape and the Internet Explorer. These programs recognize this language as the method used to format the text, insert images, create hypertext and fill-in forms. HTML is easy to learn and use. This book explains the main features of the language and suggests some principles of style and design. Within a few hours, you can create a personal Home Page, research paper, company profile, questionnaire, etc., for world-wide publication on the Web.



BP377—Practical Electronic Control Projects \$6.95. Electronic control theory is presented in simple, non-mathematical terms and is illustrated by many practical projects suitable for the student or hobbyist to build. Discover how to use sensors as an input to the control system, and how to provide output to lamps, heaters, solenoids, relays and motors. Also the text reveals how to use control circuits to link input to output including signal processing, control loops, and feedback. Computer-based control is explained by practical examples.

BP411—A Practical Introduction to Surface Mount Devices \$5.95. This book takes you from the simplest possible starting point to a high level of competence in working with Surface Mount Devices (SMD's). Surface mount hobby-type construction is ideal for constructing small projects. Subjects such as PCB design, chip control, soldering techniques and specialist tools for SMD are fully explained. Some useful constructional projects are included.

BP136—25 Simple Indoor and Window Aerials \$5.50. Many people live in flats and apartments where outdoor antennas are prohibited. This does not mean you have to forgo shortwave listening, for even a 20-foot length of wire stretched out under a rug in a room can produce acceptable results. However, with experimentation and some tips, you may well be able to improve further your radio's reception. Included are 25 indoor and window antennas that are proven performers. Much information is also given on shortwave bands, antenna directivity, time zones, dimensions, etc. A must book for all amateur radio enthusiasts.

BP336—A Concise User's Guide to Lotus 1-2-3 Release 3.4 \$7.25. Discover how to use a three-dimensional Lotus spreadsheet in the shortest and most effective way. The book explains how: to generate and manipulate 3-dimensional worksheets and how to link different files together; to generate and add graphs to a worksheet, edit them, and then preview and print the worksheet; to use the SmartIcons and become more productive with your time; to use the WYSIWYG add-in to produce top quality screen and printed displays; and much more.

BP379—30 Simple IC Terminal Block Projects \$6.50. Here are 30 easy-to-build IC projects almost anyone can build. Requiring an IC and a few additional components, the book's 'black-box' building technique enables and encourages the constructor to progress to more advanced projects. Some of which are: timer projects, op-amp projects, counter projects, NAND-gate projects, and more.

BP401—Transistor Data Tables \$6.95. The tables in this book contain information about the package shape, pin connections and basic electrical data for each of the many thousands of transistors listed. The data includes maximum reverse voltage, forward current and power dissipation, current gain and forward transadmittance and resistance, cut-off frequency and details of applications.

BP403—The Internet and World Wide Web Explained \$6.95. You've heard about the Information Superhighway. Sort of makes you feel timid about getting on the Web. Put your fears aside! This book eliminates the mystery and presents clear, concise information to build your confidence. The jargon used is explained in simple English. Once the tech-talk is understood, and with an hour or two of Web time under your belt, your friends will call you an Internet guru!

BP92—Electronics Simplified: Crystal Set Construction \$2.69. This book is written for those who wish to participate in electronics more through practical construction than by theoretical study. It is designed for all ages upwards from the day when one can read intelligently and handle simple tools. The crystal set projects are designed to use modern inexpensive components and home-wound coils. A book highly recommended for all newcomers.

ETT1—Wireless & Electrical Cyclopeda \$5.75. Step back to the 1920's with this reprinted catalog from the Electro Importing Company. Antiquity displayed on every page with items priced as low as 3 cents. Product descriptions include: Radio components, kits, motors and dynamos, Leyden jars, hot-wire meters, carbon mikes and more. The perfect gift for a radio antique collector.

ELECTRONIC TECHNOLOGY TODAY INC.
P.O. BOX 240, Massapequa, NY 11762-0240

Name _____
Address _____
City _____ State _____ Zip _____

SHIPPING CHARGES IN USA AND CANADA

\$0.01 to \$5.00.....	\$2.00
\$5.01 to \$10.00.....	\$3.00
\$10.01 to \$20.00.....	\$4.00
\$20.01 to \$30.00.....	\$5.00
\$30.01 to \$40.00.....	\$6.00
\$40.01 to \$50.00.....	\$7.00
\$50.01 and above.....	\$8.50

SORRY No orders accepted outside of USA & Canada

No. of Books Ordered <input type="checkbox"/>	
Total price of books	\$ _____
Shipping (see chart)	\$ _____
Subtotal	\$ _____
Sales Tax (NYS only)	\$ _____
Amount Enclosed	\$ _____

All payments must be in U.S. funds!

NW2 Allow 6-8 weeks for delivery



NEW PRODUCTS

USE THE FREE INFORMATION CARD FOR FAST RESPONSE

Multimedia LCD Projector

DESIGNED FOR MOBILE PRESENTATIONS, the NoteVision Model XG-NV1U is Sharp's slimmest, most compact multimedia LCD projector to date. The

TV lines. It has a composite video input for standard NTSC, PAL, and SECAM sources as well as an S-Video input. A 1:1.14 manual zoom lens lets users adjust

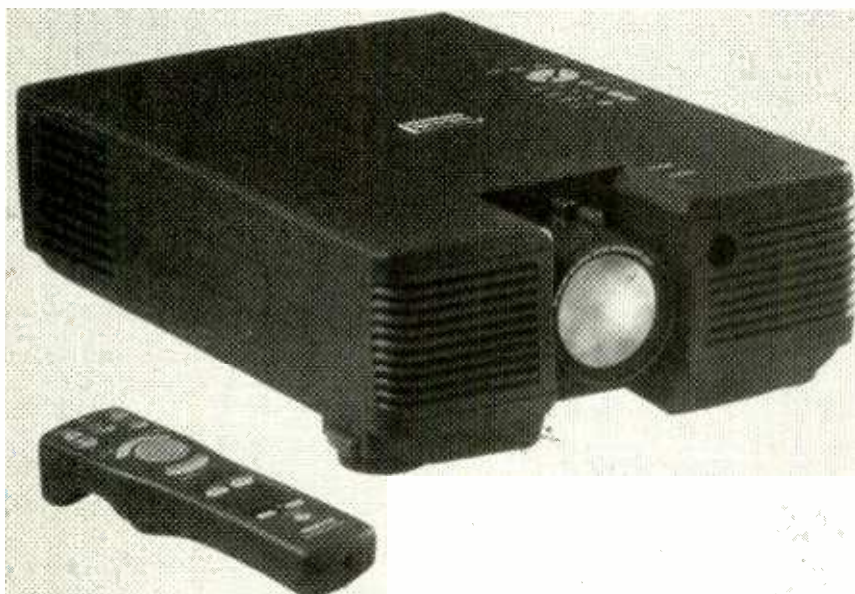

CIRCLE 20 ON FREE INFORMATION CARD

NoteVision has a very small footprint—only slightly larger than a sheet of ledger paper—and stands just five inches tall. Weighing less than 15-1/2 pounds, and equipped with built-in carrying handle, stereo amplifier and speakers, and wireless mouse control, the projector is well-suited for presenters on-the-go.

For bright, high-impact presentations, the NoteVision offers 400-ANSI lumen brightness and full SVGA (800 × 600) and Macintosh (834 × 624) resolutions. The projector has three 1.3-inch polysilicon thin film transistor (TFT) active-matrix LCD panels, each containing 519,168 pixels. With a 250-watt metal-halide lamp working in unison with those panels, the NoteVision produces crisp, bright data/video images with a resolution of 540 scan-doubled

the screen size to suit their needs. Images can be projected from 40 inches to 300 inches (measured diagonally).

A mail-in promotion offers free Astound software on CD-ROM with purchase of the projector. Astound 4.0 is used for "interactive" presenting. Any shape, picture, text block, or multimedia object can trigger "jumps" to other areas of a presentation and other applications.

The NoteVision XG-NV1U has a suggested list price of \$7995.

SHARP ELECTRONICS CORPORATION

Professional LCD Products Division

Sharp Plaza

Mahwah, NJ 07430-2135

Tel: 201-529-8731

Fax: 201-529-9636

Web site: <http://www.sharp-usa.com>

Morse Code Tutor

You can learn Morse code anywhere with the pocket-sized MFJ-418 Morse Code Tutor. Designed to quickly take you from knowing zero code to solid copy, the device offers a proven beginner's course based on the ARRL method. You learn individual letters, numbers, and prosign sets first. Previously learned sets are combined with new sets to reinforce all that you've learned. If certain characters give you trouble, you can custom build and save a set of problem characters for extra practice. Select letter, number, punctuation, prosign, or code test sets, random call signs, random words, QSOs, combination sets—or make up your own practice sessions. The "SettingSaver" feature automatically saves all custom-made settings.



CIRCLE 21 ON FREE INFORMATION CARD

To help you get ready for your FCC exam, the MFJ-418 allows you to practice copying realistic, on-the-air-style plain-English QSOs. When you're comfortable copying those, you'll be ready to pass and upgrade. You can change the speed while practicing, without having to reset every time you want to slow down or increase the pace. The "Word Recognition Mode" gives you hundreds of words commonly used in amateur radio, so that you learn to recognize entire words instead of individual letters.

The interactive mode lets you decide when to copy the next or previous group and how many times. You can select normal or Farnsworth spacing, which makes it easier to recognize entire characters. Farnsworth character speed is adjustable

from 10 to 60 words per minute. You can also use fixed-length or more realistic random-length groups, with up to eight characters per group setting.

The MFJ-418 Morse Code Tutor costs \$79.95.

MFJ ENTERPRISES, INC.

300 Industrial Park Road
Mississippi State, MS 39762

Tel: 1-800-647-1800

Fax: 601-232-6551

Web site: <http://www.mfjenterprises.com>

One-Time-Programmable Microcontroller

Intended for mixed-signal applications that are space-constricted, highly complex, and feature-intensive, Microchip Technology's PIC16C715 8-bit one-time-programmable (OTP) microcontroller offers accurate A/D converter capabilities with 2048 words (2K x 14) of on-chip EPROM program memory and 128 bytes of RAM for data memory. The device allows for full, affordable A/D converter capability in applications requiring the execution of complex algorithms and control code—where microcontrollers with comparators once were the only cost-effective solution. Existing PIC16C710 and -711 designs can easily be migrated up to the enhanced performance of the new microcontroller (as well as moving down from the PIC16C72), while maintaining their code compatibility.



CIRCLE 22 ON FREE INFORMATION CARD

The PIC16C715 reduces external components and eases system design by offering a brown-out detect that resets the microcontroller when a low-voltage situation has occurred and allows for easy system restart. User-selectable parity bits can be used to monitor the contents of

program memory for error conditions, allowing the system's software to act on the error. The on-chip, four-channel, 8-bit A/D converter eliminates the need for discrete A/D in embedded measurement applications. A/D data-conversion time is 16 microseconds at 20 MHz.

The device features 35 powerful single-word instructions, 200 nanosecond single-cycle instructions, 3.0–5.5 operating voltage, 20-MHz maximum clock speed, power dissipation of less than 2 mA at 5 volts/4 MHz, four analog inputs, and in-circuit serial programming. Typical applications include motor control, instrumentation, environmental control, pointing devices, joystick control, smoke and carbon-monoxide detectors, car alarms, and smart battery packs.

Pricing in 1000-unit quantities is \$3.44 each in commercial PDIP versions. The PIC16C715 is available in 18- and 20-pin windowed CERDIP, PDIP, SOIC, and SSOP packages and commercial, industrial, and automotive temperature versions.

MICROCHIP TECHNOLOGY INC.

3255 West Chandler Blvd.

Chandler, AZ 85224-6199

Tel: 602-786-7200

Fax: 602-899-9210

Rugged Digital Multimeter

Built tough to meet the rigors of field-service work, Wavetek's Model HD110



CIRCLE 23 ON FREE INFORMATION CARD

digital multimeter can withstand drops of up to 10 feet onto concrete surfaces without damage. The DMM is water- and splash-proof for outdoor use under inclement conditions. With a battery life of 1500 hours, downtime is virtually eliminated.

The Model HD110 has a measuring range of 1500 volts DC, 1000 volts AC, AC/DC current to 10 amps, and resistance to 20 megohms. It provides diode and continuity testing, 0.1% accuracy, and 6-kV transient overload protection. The oversized display features 0.8-inch characters.

The HD110 digital multimeter is priced at \$219.95.

WAVETEK CORPORATION

9045 Balboa Avenue
San Diego, CA 92123

Tel: 619-279-2200

Fax: 619-565-9558

Two-Line Call Sequencer

Small businesses can project bigger images with Viking Electronics' TMS-2 call sequencer. Rather than routing callers to voice mail systems or answering machines, the TMS-2 keeps the caller on the line, with music or a promotional message on hold using a



CIRCLE 24 ON FREE INFORMATION CARD

Viking DVA-2W. After answering the call, playing a customized message, and placing the call on hold, the TMS-2 provides audible and visible reminders every 15 seconds to keep the user aware of the waiting call. Switchable day/night modes allow the device to route incoming calls from either line to a single answering machine when the user is not available to answer the phone.

The TMS-2 two-line call sequencer has a suggested retail price of \$239.

VIKING ELECTRONICS

1531 Industrial Street

Hudson, WI 54106

Tel: 715-386-8861

E-mail: Sales@VikingElectronics.com

Get 3 Books For Only \$9.95

CHOOSE FROM
40 GREAT SELECTIONS!

when you join the
Electronics Engineers' Book Club®

**Values To
\$264.50!**

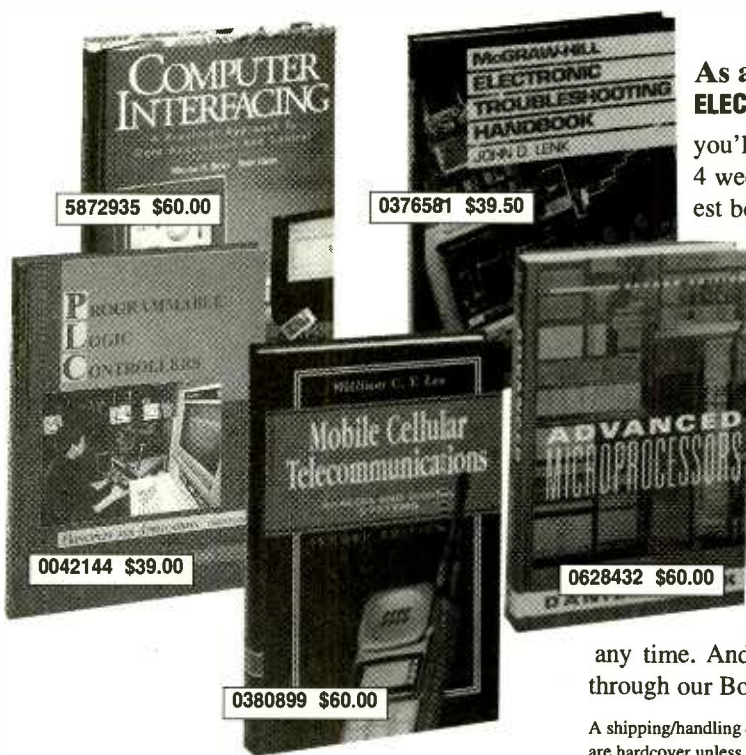

**As a member of the
ELECTRONICS ENGINEERS' BOOK CLUB...**

you'll enjoy receiving Club bulletins every 3-4 weeks containing exciting offers on the latest books in the field at savings of up to 50% off the regular publishers' prices. If you want the Main Selection, do nothing and it will be shipped automatically. If you want another book, or no books at all, simply return the reply form to us by the date specified. You'll have at least 10 days to decide. If you ever receive a book you don't want due to late delivery of the bulletin, you can return it at our expense. Your only obligation is to purchase 3 more books during the next 2 years, after which you may cancel your membership at any time. And, you'll be eligible for FREE BOOKS through our Bonus Book Program.

A shipping/handling charge and sales tax will be added to all orders. All books are hardcover unless otherwise noted. Publishers' Prices Shown. © 1997 EEC

ELECTRONICS ENGINEERS'
BOOK CLUB

A Division of The McGraw-Hill Companies, P.O. Box 549, Blacklick, OH 43004-9918

YES! Please send me the books listed below, billing me just \$9.95, plus shipping/handling & tax. Enroll me as a member of the **Electronics Engineers Book Club®** according to the terms outlined in this ad. If not satisfied, I may return the books without obligation and have my membership cancelled.

--	--	--

If you select a book that counts as 2 choices, write the book number in one box and XX in the next.

Name _____ Area of specialization _____

Address/Apt. # _____

City/State _____ Zip _____ Phone() _____

valid for new members only, subject to acceptance by EEC. Canada must remit in U.S. funds drawn on U.S. banks. Applicants outside the U.S. and Canada will receive special ordering instructions. A shipping/handling charge & sales tax will be added to all orders.

DRE697C

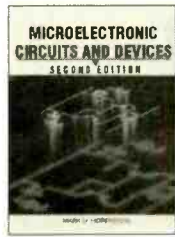

5872587 \$80.00

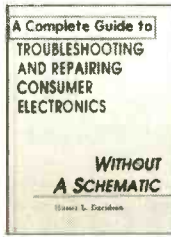

0156492 \$34.95

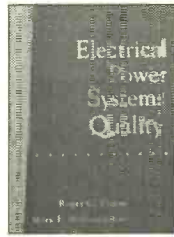

0180318 \$55.00

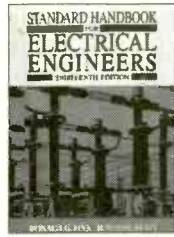

0209847-XX \$125.00
Counts as 2

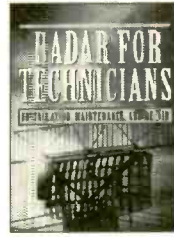

#240620 \$45.00



0289778-XX \$56.00
Counts as 2

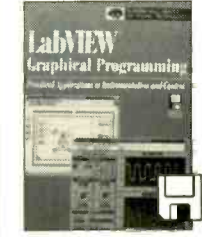

0326924-XX \$45.00
Counts as 2

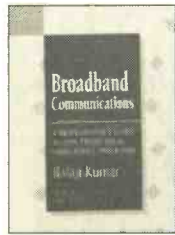

0359687 \$65.00

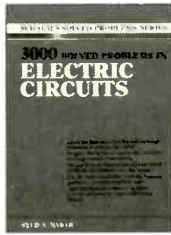

0459363 \$22.95
Softcover

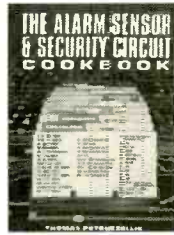

0497060 \$29.95



0523746-XX \$55.00
Counts as 2



5873311 \$73.00



0704414-XX \$79.50
Counts as 2

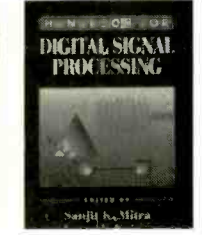

5867737 \$95.00



0717753 \$19.95
Softcover

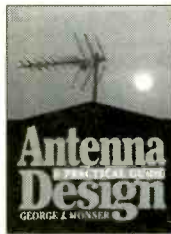

0428433 \$60.00



9119018 \$32.95
Softcover

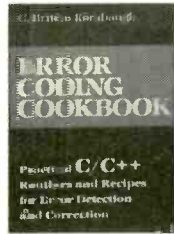

9117201 \$55.00

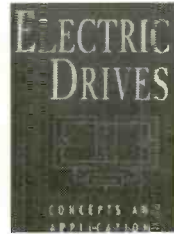

4603701 \$70.00



5872927-XX \$82.00
Counts as 2



0520550 \$60.00

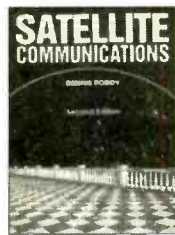

0533709 \$60.00



0056692 \$55.00

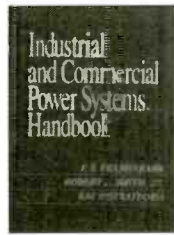

0506248 \$69.50



0709645 \$70.00



337936X \$55.00



0280495 \$60.00

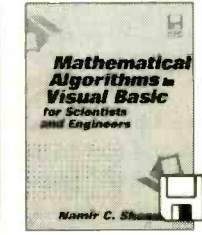

9120032 \$45.00

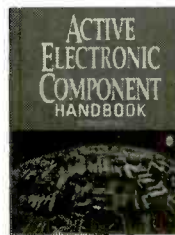

0266921 \$79.50

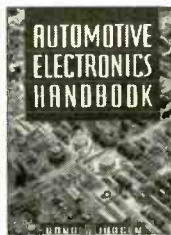

0331898 \$89.50

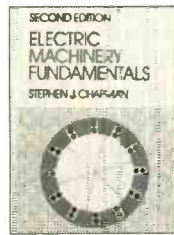

0109141 \$77.34



059273X \$65.00



5875551 \$69.95



0239193 \$27.95
Softcover



911525X \$50.00

CUTTING-EDGE INFORMATION FOR TODAY'S ENGINEER...

ELECTRONICS ENGINEERS'
BOOK CLUBSM

A Division of The McGraw-Hill Companies,
P.O. Box 549, Blacklick, OH 43004-9918



NEW LITERATURE

USE THE FREE INFORMATION CARD FOR FAST RESPONSE

Developing a LabWindows/CVI Instrument Driver: Application Note 022

National Instruments
6504 Bridge Point Parkway
Austin, TX 78730-5039
Tel: 1-800-433-3488
Fax: 512-794-8411
E-mail: info@natinst.com
Web site: <http://www.natinst.com>

Free

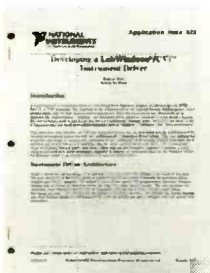

CIRCLE 338 ON FREE INFORMATION CARD

Instrument drivers simplify instrument communication and save users time that they have traditionally spent configuring low-level instrument command syntax. This 23-page application note explains the

core LabWindow/CVI instrument drivers and how to modify them to develop new drivers. Sections on recommended styles for building function panels, adding online help, and adding user-callable functions demonstrate how to create a custom instrument driver. Diagrams and examples illustrate the text. Two appendices contain a checklist for instrument-driver developers and a sample driver for the Tektronix 2430 oscilloscope, including the seven-page source file.

Users and instrument vendors who have developed drivers can upload them to National Instruments' Instrument Driver Network on the World Wide Web (<http://www.natinst.com/idnet>) for inclusion at the site. The Instrument Driver Network is a library of more than 550 LabWindows and LabVIEW instrument drivers that users can download free of charge. Users can also request new drivers, search for specific drivers, and download driver development tools.

Howard W. Sams and Company Internet Guide to the Electronics Industry

by John Adams
Prompt Publications
2647 Waterfront Parkway, East Drive
Indianapolis, IN 46214-2041
Tel: 1-800-428-7267
Web site: <http://www.hwsams.com>
\$16.95

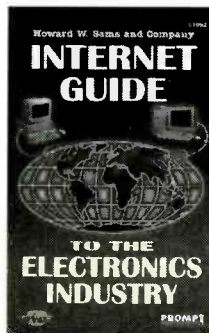

CIRCLE 339 ON FREE INFORMATION CARD

To people who work in the electronics industry, the Internet can be as invaluable a tool as a multimeter or an oscilloscope. Tremendous amounts of data stored in computers from around the world can be

accessed almost instantaneously on the Internet. Unfortunately, finding information on the Internet can be a time-consuming, frustrating chore—unless you have this book to guide you.

Aimed at hobbyists as well as professionals, the book first provides useful information about the Internet and how to use it. It then presents a complete, up-to-date directory of electronics resources on the Internet along with instructions on how to reach them. The book helps you locate information on resources for software, hardware, books and magazines, projects, contests, datasheets, and firmware. It tells you how to uncover product applications, company information, product wholesale and retail information, technical support, free product samples, IC pinouts, company contacts, e-mail addresses, and product pictures. It also helps you get in touch with other people in the world of electronics through online chat lines and discussion groups.

Speech Coding: A Computer Laboratory Textbook

by Thomas P. Barnwell III,
Kambiz Nayebi, and Craig H. Richardson
John Wiley & Sons, Inc.
605 Third Avenue
New York, NY 10158-0012
Tel: 1-800-225-5945
Web site: <http://www.wiley.com>
\$37.95, including disks

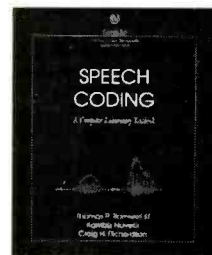

CIRCLE 340 ON FREE INFORMATION CARD

As part of the Georgia Tech Digital Signal Processing Laboratory Series—a lab series for DSP that operates on personal computers—this book offers you a hands-

on experience with speech processing, with an emphasis on speech coding. The book/disk package covers all the basic approaches found in modern speech coders. A DOS-based PC with a floating point processor and the software that accompanies the book are all that you need to develop an understanding of the principles of speech coders and an intuitive sense of how modern speech coders work.

The book puts a wealth of speech-analysis tools at your fingertips. It is packed with exercises and projects for experimentation with algorithms—which are described in both simple parametric terms and complete equation form. The book includes a short, concise description of many different types of speech coders—pulse-code modulators, adaptive pulse-code modulators, adaptive differential pulse-code modulators, adaptive predictive coders, linear predictive coders, code-excited linear predictive coders, multi-pulse excited linear predictive coders, sub-band coders, and transform coders—for easy reference.

In addition, the DPS laboratory soft-

ware features a powerful graphical user interface that makes it easy to use. With pull-down menus, interactive graphics, extensive analysis programs, and help functions, little or no training is needed to use the software.

Networking Windows NT 4.0 Workstation and Server Third Edition

by John D. Ruley
John Wiley & Sons, Inc.
605 Third Avenue
New York, NY 10158-0012
Tel: 1-800-225-5945
Web site: <http://www.wiley.com>
\$34.95



CIRCLE 341 ON FREE INFORMATION CARD

Written by the senior technical editor and NT columnist at *Windows Magazine* with help from a team of NT experts, this book reveals everything needed to plan, build, manage,

troubleshoot, expand, and develop NT-based corporate networks with Windows NT. It is aimed at network administrators looking to connect an NT component to a UNIX or NetWare system, people trying to decide between NT Server and NT Workstation, and network managers updating to 4.0. The book explains how to use NT networking, connect with TCP/IP, and use Internet enterprise and Novell connections. It describes the installation and management of NT Server and Workstation, and covers administering and interoperating with TCP/IP. Readers learn how to plan and manage NT-based local-area, wide-area, and enterprise-wide networks.

The third edition of this comprehensive resource for network managers on both the workstation and server versions of Windows NT 4.0 has been completely revised to include all of the updated features of version 4.0, including dynamic DNS support, NetWare redirector, remote-access support, universal modem driver, telephony API, and crypt-to API. An entire chapter is devoted to new Internet-related features like IIS (Internet Information Server), 4.0's built-in Web server, and the new peer

Web server PPTP, which allows you to use the Internet like a private network.

Hands-On Netscape: A Tutorial for Windows Users

by David Sachs & Henry Stair
Prentice-Hall PTR
One Lake Street
Upper Saddle River, NJ 07458
Fax: 201-236-7123
Web site: <http://www.prenhall.com>
\$39.95, including CD-ROM
Netscape, with its user-friendly,



CIRCLE 342 ON FREE INFORMATION CARD

Navigator. The book uses a proven, hands-on approach to walk you step-by-step
continued on page 67

AT \$299.95, NO OTHER DESIGN WORKSTATION GIVES YOU SO MUCH FOR SO LITTLE.



Large Breadboarding area
holds 24 ICs
...2,500 tie points with
Life Time Guarantee!

Available now
assembled or
in kit form

Triple Power Supply
...5V fixed, plus
two variable ± 1.3 to $\pm 15V$ DC
with short circuit
protection

Function Generator
...sine/square/triangle
...plus TTL

8 TTL Logic
Probe Indicators

UL-CSA
Approved



Audio Speaker

Two Digital
Pulsers

Two BNC Connectors
for oscilloscopes
and counters

Remainder
of trainer now has
a 3 YEAR warranty

OVER \$600 WORTH
OF WORLD CLASS
TEST EQUIPMENT
FOR UNDER \$300!

The PB-503 is a total design workstation. It has everything! Instrumentation, including a function generator with continuously variable sine/square/triangle wave forms—plus TTL pulses. Breadboards with 8 logic probe circuits.

And a Triple Power Supply with fixed 5VDC, plus two variable 1.3 outputs (+1.3 to 15VDC and -8 to 15VDC). Throw in 8 TTL compatible LED indicators, switches, pulsers,

potentiometers, audio experimentation speaker...plus a lifetime guarantee on all breadboarding sockets! You have everything you need right there in front of you! PB-503—one super test station for under \$300! Order yours today!!

**GLOBAL
SPECIALTIES**

Can't Wait! Call Toll-Free For More Information
1-800-572-1028



or the name of your local distributor

70 Fulton Terrace, New Haven, CT 06512
(203) 466-6103 • Fax: (203) 468-0060

an
Interphase
Industries
company

CIRCLE 122 ON FREE INFORMATION CARD

Repairing Remote Controls

WELCOME TO THE FIRST INSTALLMENT OF THE ALL NEW SERVICE CLINIC. AS YOU CAN SEE FROM THE BYLINE, MY NAME IS SAM GOLDWASSER. THOSE OF YOU THAT FREQUENT THE INTERNET MIGHT BE FAMILIAR WITH MY ONLINE

repair and troubleshooting guides, located at <http://www.paranoia.com/~fil-ipp/REPAIR/>, and mirrored at several sites around the world. If not, perhaps a little introduction would be in order.

An electrical engineer by profession, I have always had a passion for fixing mechanical and electronic devices. As a kid, household appliances represented the beginning of my fascination with technology. It wasn't long before the workings of the TV were of more interest to me than the shows on its screen. Naturally I had to see what was inside everything. Fairly soon, I figured out that getting things back together again was generally not that much more difficult than disassembling them in the first place. That insatiable

curiosity and unending search for challenges continue to this day.

After a long and varied career in engineering, teaching, and business, these days I am an independent engineering consultant, but spend much of my time

helping others on the Internet news-groups; writing the Internet repair and troubleshooting guides mentioned above, as well as other articles; providing free repairs for those who cannot afford professional service; and doing other things that I find interesting. For now, this is more fun and much more rewarding than a real job.

With that out of the way, let's turn to our first topic.

Remote Control Repair

Fifteen years ago, a wireless remote

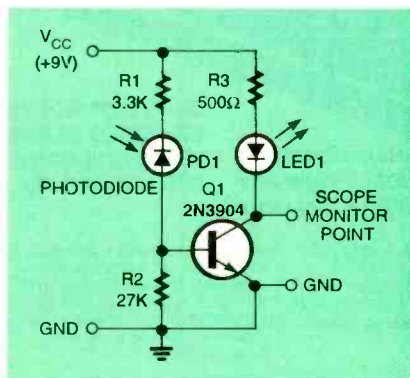
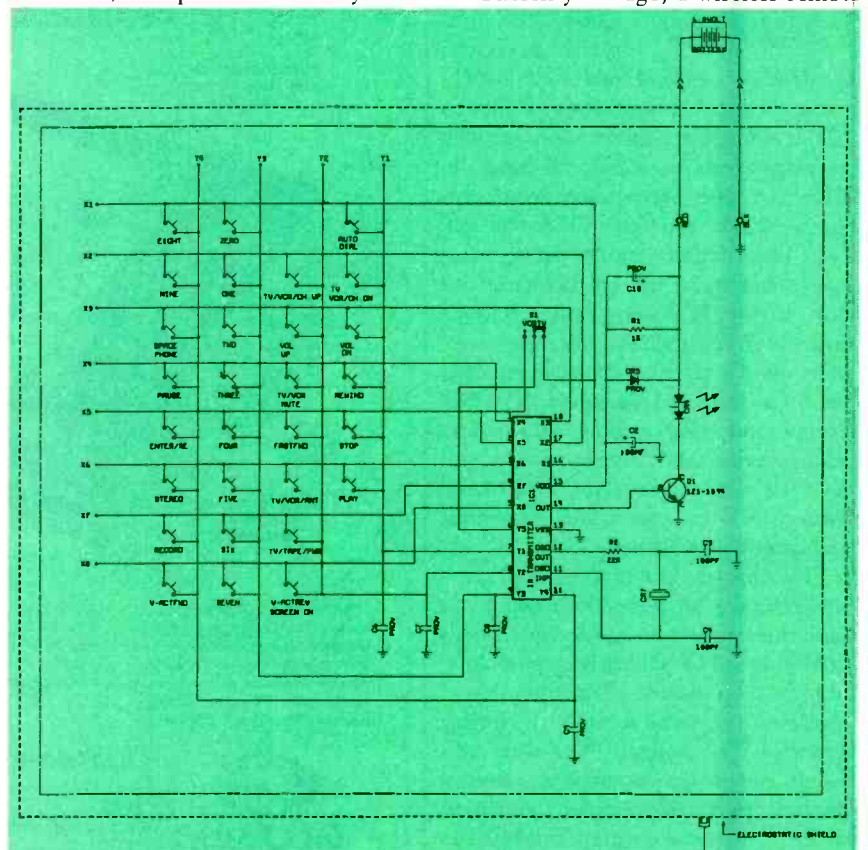

FIG. 1—THIS IR DETECTOR CIRCUIT could be used for testing IR remote controls, CD-player laser diodes, and other low-level, near IR emitters. Component values are not critical. Test points are provided for use with an oscilloscope.



INSIDE A TYPICAL TV/VCR remote control transmitter. This schematic is for a unit made by Zenith.

control was a \$50 or \$100 option (in 1980 dollars) to a TV or VCR. Early units used ultrasonic or RF analog signals and could perform only limited functions. You were lucky to get anything beyond on/off, volume, and channel up/down.

Today, a remote control is standard even with low-cost, basic electronic equipment. Nearly all modern remotes use Infra-Red (IR) light for digital data transmission. Some have more buttons and functions than a personal computer! Unfortunately, those added features and functions sometimes come with a burden of its own—many remotes have row upon row of tiny, identical size buttons with no logical layout of functions. On the other hand, some are masterpieces of ergonomic engineering, almost operating by themselves.

There are two kinds of problems with remotes:

1. They seem to have legs of their own and disappear at the most inconvenient times.

2. They get abused by being dropped, dunked in Coke or beer, or chewed on by the pet tiger, or are left alone to develop dead, leaky batteries.

While there are some remotes that will respond to a whistle and beep back to identify their locations, most are the ordinary deaf, dumb, and blind variety. Unfortunately, I can not help you locate your missing remote. If you suffer from disappearing remote syndrome, a well-designed universal remote—on a tether—might make a good investment.

Fortunately, most actual problems with remotes can be solved relatively easily. First of all, it is important to recognize that most failures are of a physical nature. Since remotes operate on low voltages under non-stressful conditions, spontaneous electronic failure is relatively uncommon. In short, if you don't abuse your remote control, it is likely to go a long time between failures.

Testing Remotes

All troubleshooting begins with the simplest steps. Start by eliminating the obvious. First, confirm that your problem is not simply due to a selector switch in the wrong position or an accidental press of a key selecting VCR instead of TV. If your broken unit is a universal type, make sure it has not simply forgotten its programming or codes—reinitialize it. A common cause of memory loss is the batteries failing



Raise your standard to Wavetek.

Why choose between paying more for a brand name or getting more functions for your money? Get the best of both worlds with **Wavetek**.

Worldwide Service.

Support whenever and wherever you need it.

Tech-preferred Features.

The XL meters have the largest displays, auto-off, data hold, manual and autoranging models in pocket-size convenience.

Quality. Less than 0.5% warranty returns assures continuous reliability.

Selection. Over 35 different **Wavetek** DMMs to meet any measurement need.

User Safety. Conservative voltage ratings, fused inputs, warning beepers, shrouded test leads, and designs that meet worldwide agency approvals.

Total Value. Eight XL Series meters from \$29.95 to \$99.95 to meet any requirement.

You don't need to pay more.
You can't afford to settle for less...

For the name and location of the **Wavetek** dealer near you, call

1-800-854-2708

(outside the U.S., call 619-279-2200)

Wavetek Corporation

9045 Balboa Avenue,
San Diego, CA 92123

©Wavetek Corp., 1995. Wavetek and the Wavetek logo are registered trademarks of the Wavetek Corporation

WAVETEK

CIRCLE 98 ON FREE INFORMATION CARD

out or losing contact for an instant due to a fall or bump.

Also double check to be certain that you are using the correct remote. A lot of remotes look alike, and sometimes remotes for similar equipment from the same manufacturer can not be swapped.

Next, try to determine whether the problem is indeed in the remote itself and not the controlled equipment. The easiest way to do that is to temporarily program a universal remote to match your equipment. If that equipment then operates successfully, you can be pretty certain that the problem lies in the remote unit.

Diagnosing the Problem

To narrow down the problem, use an IR detector to determine if the remote is emitting an IR signal when each button is pressed. While such a device does not guarantee that the signal is correct, it eliminates most common problems from consideration. An IR detector card or an IR detector circuit (like the one shown in Fig. 1) is very handy for testing remote controls and other IR emitters. Another alternative is to use a camcorder: Some camcorders are sensitive to IR as well and will show a bright spot of light if aimed at a working source of IR.

Modern remotes use a pulse-code-modulated carrier to send the command. A typical carrier frequency is around 36- to 56-kHz, with each pulse consisting of multiple cycles (e.g., 20 for each bit) of that carrier. For buttons that repeat, typical rates are 10 to 20 Hz, and the entire code might actually be sent only when the button is first pressed with only a repeat code sent while it is held down. The carrier frequency and coding schemes have apparently not been standardized and vary quite a bit, even from device to device from the same manufacturer. Therefore, it is beyond the scope of this document to enumerate them all.

If more information is needed or desired, it is possible to monitor the waveforms with an oscilloscope. That could be done by monitoring internal signals of the remote including certain pins on the main IC as well as the LED or its driver. A simpler approach would be to monitor the signal across the transistor in the detector circuit of Fig. 1; the schematic includes test points for that purpose.

Speaking of the detector circuit, the only important point to keep in mind when building the circuit is to make sure that the LED is placed so that its light

can't fall upon the photodiode. Select a photodiode that is sensitive to near IR (about 750 to 900 μm). You could also salvage one from an optocoupler or photosensor. Dead computer mice also use photodiodes that could be salvaged. Finally, a salvaged IR sensor module from a TV or VCR might also be used as an IR detector. Those usually operate from a single supply (5 V to 12 V is typical) and output a clean demodulated signal (you will not see the carrier, only the 1s and 0s).

Once we are certain that the remote is at fault, it is time to see if we can repair it, or if it is even worthwhile to do so. Unfortunately, as we have used up all of our room for now, that's a topic that will have to wait until next month. Until then, you can visit the sci.electronics.repair FAQ homepage which is located at <http://www.paranoia.com/~filipg/REPAIR/>. If you've got comments or questions, you can e-mail them to me at sam@stdavids.picker.com. **EN**

WHAT'S NEWS

continued from page 6

"Initially, NGI will be a national network, but we are looking for international partners to meet our global needs," said Falsetti. "A workshop is planned for May in Washington, DC, to get feedback from industry and academia and to involve them in the project."

National, Real-Time Travel Information

Etak, Inc., a developer of digital mapping technology, and Metro Networks, Inc., the oldest and largest traffic-reporting service in the U.S., plan to develop the first nationwide, real-time traveler-information system. The system will transmit a variety of traffic and traveler information as it occurs, to mobile PCs, message watches, cable TV, video kiosks, and other devices.

The reports will inform drivers of regional traffic incidents, traffic speeds, road conditions and construction, special events, and weather conditions. Using FM-subcarrier broadcasts and other distribution media, traffic information will be sent to a variety of wireless products and services, including car navigation systems, notebook PCs, pagers, and cellular phones. It will also be available for fixed devices, such as computers via the Internet, as well as cable TV and interactive TV.

Data will be output in several transmission formats that can be used in consumer-oriented message devices anywhere in the country. Crisis response, traffic management, fleet-management, and other services that use a single central dispatch center will also benefit from having current road information readily available.

Real-time traffic information will be available in 10 metropolitan areas this year, with 20 more added in both 1998 and 1999. The first 10 areas will include New York, Los Angeles, Chicago, San Francisco, Detroit, Atlanta, Seattle, and Houston. The other two cities have yet to be announced.

Each Metro operation is equipped to collect comprehensive traffic and mobility information from both government sources and Metro sources such as helicopters and fixed-wing aircraft for aerial

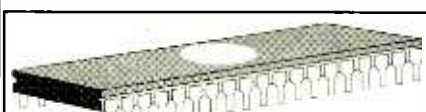

CABLE CONVERTER DIAGNOSTIC TEST CHIP

LOAD FULL ACTIVATION OF CABLE CONVERTER

WE STOCK A COMPLETE LINE OF CHIPS, TOOLS, WIRELESS QUICK INSTALL TEST BOARDS AND DIAGNOSTIC CUBES FOR ALL CONVERTERS!

*****ANYONE IMPLYING ILLEGAL USE WILL BE *****

DENIED SALE. WE SELL PRODUCTS ONLY!! TO TECHNICIANS OR CABLE REPAIR FACILITIES!!

#1 IN CUSTOMER SERVICE & TECH. SUPPORT!

***ALL ORDERS SHIP WITHIN 24HRS, UPS/ FED-X.**

***PRIORITY NEXT DAY SHIPPING AVAILABLE!**

***SALE= BUY 5 TEST BOARDS AND GET 1 FREE.**

***MON-FRI - 8AM-7PM - SAT 10AM-2PM EST.**

***WEB PAGE [HTTP://WWW.800-GOCABLE.COM](http://WWW.800-GOCABLE.COM)**



COMMUNICATIONS INC.

ORDERS/CATALOG 1-800-GO-CABLE

TECHNICAL SERVICE DEPT. 717-620-4363 EST. 1976

ANTIQUE RADIO CLASSIFIED Free Sample!

Antique Radio's
Largest Circulation Monthly
Articles, Ads & Classifieds.



6-Month Trial: \$18.95 1-Yr: \$36.95 (\$53.95-1st Class).
A.R.C., P.O. Box 802-L17, Carlisle, MA 01741
Phone: (508) 371-0512 VISA/MC Fax: (508) 371-7129

SINGERS! REMOVE VOCALS

Unlimited Low Cost. Instantly Available
Background Music from Original Standard
Recordings! Does Everything Karaoke
does... Better and gives you the
Thompson Vocal Eliminator™
Free Brochure & Demo Tape
LT Sound Dept. EN-1
7980 LT Parkway, Lithonia, GA 30058
Internet: <http://ltsound.com>
24 Hour Demo/Info Request Line (770) 482-2485 Ext 72
When You Want Something Better Than Karaoke!



surveillance and broadcast-quality camera systems. Collected data is immediately processed, and translated into concise reports. Metro disseminates the information via three computerized, proprietary systems, through live on-air traffic reports provided to radio and television affiliates, and, in some cases, via cell phones and through newspaper audio-text services.

Etak's Traffic Workstation (TWS) consolidates all of that information and places it into standard formats suitable for uniform transmission to wired and wireless devices anywhere in the United States. An Etak TWS will be placed in each of the 60 Metro offices in more than 50 metropolitan areas.

"Smart Gun" Could Save Police Lives

One out of every six police officers who are killed in the line of duty are shot in "takeaway" incidents, when a criminal grabs an officer's gun and turns it on him or her. In such situations, the "smart gun" developed by Colt Manufacturing Company would recognize that it was in the wrong hands and refuse to fire.

Colt's prototype .40-caliber semiautomatic pistol fires only in the hands of its owner. The gun, which is the result of a two-year, \$620,000 study done by Sandia National Laboratories for the National Institute of Justice, uses radio-frequency technology to block an unauthorized person from using it. The smart gun will fire when activated by an enabling device called a transponder, which must be located within a few inches of the gun. If the gun was taken from the officer, a safety mechanism would be activated, and the gun wouldn't fire.

In the case of Colt's prototype weapon, the transponder is worn on the wrist of the authorized user. Colt plans to reduce the transponder to the size of a ring and make other improvements before it distributes 100 smart guns to police department for field testing in about a year. The company expects the new firearm to be ready for use by law-enforcement agencies in about three years, at a cost of about \$900 each (compared with \$600 for its corresponding conventional model). Colt is also considering the possibility of selling smart guns to the general public. **EN**

EQUIPMENT REPORTS

continued from page 12

it's easy enough to figure out how to work things, even without the manual. One rotary switch and eight push buttons control all functions on the DMM. The rotary switch has twelve on positions and two off positions. Some of the switch positions serve more than one function, and a pushbutton toggles between them. All of the pushbuttons serve dual functions, and a shift button activates the secondary functions. A "Store" button stores the present reading in memory and recalls the reading as its secondary function. The meter does not save the reading once power is turned off, though. A "Bar" button scrolls through four types of bargraph displays or none at all. A "Hold" button causes the meter to beep, freeze the display, and turn on an "H" indicator. A "Range" button first selects the manual ranging mode and then selects the range.

A "Setup" button scrolls through user-adjustable functions. Those functions include setting the reference value for delta measurements, setting the high and low limits, and selecting average or true RMS AC voltage. You can also switch between dBm and dB, turn the beeper on and off, set the auto-power-off and auto-backlight-off times, select 50- or 60-Hz noise suppression, and turn off the hazard-warning indicator.

The DMM916 is loaded with more features than most microwave ovens, but it's much easier to use. If you need the high-end features, they're easy to get at, but otherwise they don't get in your way. In short, using the DMM916 is a pleasure, and it will be for years to come thanks to its rugged construction. For more information, contact Tektronix directly, or circle 15 on the Free Information Card. **EN**

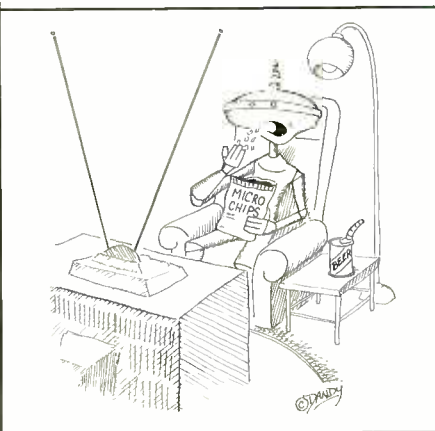

You can Build Gadgets! Here are 3 reasons why!

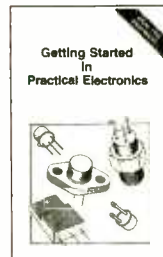

BP345—GETTING STARTED IN PRACTICAL ELECTRONICS \$5.95

If you are looking into launching an exciting hobby activity, this text provides minimum essentials for the builder and 30 easy-to-build fun projects every experimenter should toy with. Printed-circuit board designs are included to give your project a professional appearance.

BP349—PRACTICAL OPTO-ELECTRONIC PROJECTS \$5.95

If you shun opto-electronic projects for lack of knowledge, this is the book for you. A bit of introductory theory comes first and then a number of practical projects which utilize a range of opto devices, from a filament bulb to modern infrared sensors and emitters—all are easy to build.

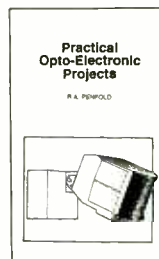

Practical Electronic Music Projects
R.A. PENFOLD

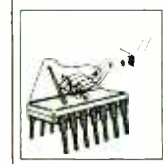

BP363—PRACTICAL ELECTRONIC MUSIC PROJECTS \$5.95

The text contains a goodly number of practical music projects most often requested by musicians. All the projects are relatively low-in-cost to build and all use standard, readily-available components that you can buy. The project categories are guitar, general music and MIDI.

Mail to:
Electronic Technology Today, Inc.
P.O. Box 240
Massapequa Park, NY 11762-0240

Shipping Charges in USA & Canada

\$0.01 to \$5.00.....\$2.00	\$30.01 to \$40.00.....\$6.00
\$5.01 to \$10.00.....\$3.00	\$40.01 to \$50.00.....\$7.00
\$10.01 to \$20.00.....\$4.00	\$50.01 and above.....\$8.50
\$20.01 to \$30.00.....\$5.00	

Sorry, no orders accepted outside of USA and Canada. All payments must be in U.S. funds only.

Number of books ordered.

Total price of books..... \$ _____
Shipping (see chart)..... \$ _____
Subtotal..... \$ _____
Sales Tax (NYS only)..... \$ _____
Total enclosed..... \$ _____

Name _____
Address _____
City _____ State _____ ZIP _____

Please allow 6-8 weeks for delivery.

Build Your Own Audio Test Gear

THIS MONTH BEGINS A NEW SERIES ON AUDIO TESTING. IT CENTERS AROUND FIVE PIECES OF TEST GEAR, AND HOW

and why they are used. Even better, while all the gear is commercially available, we'll show you how to build your own and save a bundle.

Before we go further, however, let's get into a little philosophy. For example, why do we even need to test audio systems. After all, many believe that if an audio system is working, we can hear it clearly, and it is loud enough, that it is satisfactory. In many cases, the only testing that's done after setting up a PA system is to turn it on and speak "testing, testing, 1, 2, 3, 4," into the microphone. If someone in the back of the room says, "I can hear that just fine," many would probably say that the system is working well and call it a day.

While that might be fine to a point, if that's all that's done we really do not know if the system is doing the very best job it can. To determine if a sound system—PA, stereo, surround sound, whatever—is really operating at its maximum potential we need to perform some real tests using some real test equipment. So, let's get started.

Five Basic Instruments

To completely test audio systems, five basic instruments are needed. Those are an audio source (sinewave generator); an audio voltmeter (an ordinary DMM won't do the job); an oscilloscope (it doesn't need to have a 100-MHz bandwidth, but if you own one that goes that high, you can certainly use it); a distortion analyzer; and, if you are going to work with tape decks, a wow and flutter meter.

That set of instruments comprises all of the necessary devices for performing 98% of the audio tests you are likely to need to make. Once you fully under-

continued on page 58

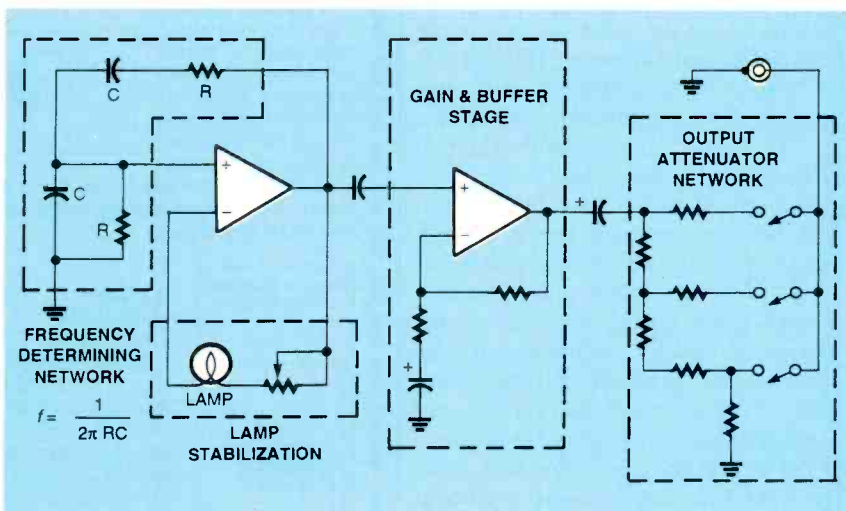

FIG. 1—HERE IS THE BASIC design of our audio signal generator. It is based on the Wien-bridges sinewave oscillator.

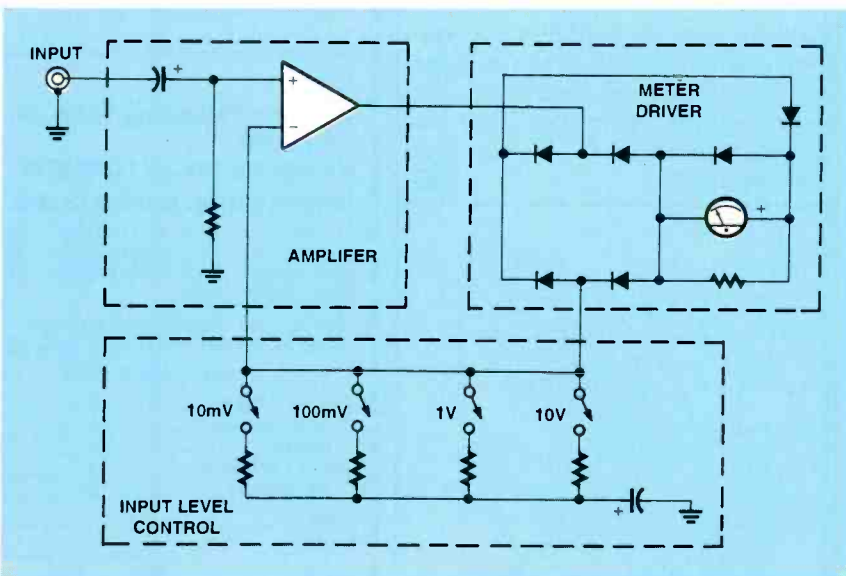

FIG. 2—AN AUDIO VOLTMETER is an important part of our audio test-gear suite, as a standard DMM will not work well for these applications.

Port I/O Under Windows 95

SOME TOPICS ARE PERENNIALY INTERESTING; EVERY FEW YEARS, IT SEEMS, IT'S NECESSARY TO TAKE ANOTHER LOOK. THAT'S NOWHERE MORE TRUE THAN WITH PC-BASED I/O. SO THIS TIME WE'LL TALK ABOUT HOW TO DO PARALLEL PORT I/O

under Windows 95. First, I'll provide a quick DOS-based example using QBasic, then a Windows example using Delphi. All code is available in the file PORTIO.ZIP on the Gernsback ftp site (<ftp.gernsback.com/pub/EN/>).

Hardware Considerations

First I would strongly recommend getting a cheap I/O card to use for any experimentation. That way, if anything goes wrong, you're not going to hurt your normal interfaces. That is an especially important consideration if your regular port is located on the system board. I used a cheap I/O card I had lying around. It appears at I/O port 0278h on my system, and is addressed (by DOS or Windows) as LPT2. That's the normal configuration, but others are possible.

To perform any of the following exercises, you'll have to know unequivocally the actual I/O address used. To find out, run DEBUG from DOS (or a DOS box). Then execute the command "d 40:0." You should see a display like the following:

```
0040:0000 F8 03 F8 02 E8 03 E8 02-BC 03
      78 02 00 00 00 00 .....x.x...
```

The port address of LPT1 is stored at offset 08, LPT2 is at 0A, LPT3 is at 0C, and LPT4 is at 0E. In the example, LPT2 appears at port 0278, and that's what the sample code is written for. However, if

your port appears at a different address, you only have to change the value of a single constant to reflect that address throughout the rest of the program.

The second thing to do is wire up a test jig. I used a 16-pin DIP ribbon cable with a compression connector on one end and bare on the other. To the bare end I soldered a 25-pin female D connector, wired as shown in Fig. 1. With that arrangement, I connected my cable to a standard 25-pin extension cable, and plugged the DIP end into a solderless breadboard mounted on my custom design jig, which includes +/-5 and +/-12-volt power supplies, a signal generator, a frequency counter, discrete LEDs, and discrete input switches. By connecting LEDs to outputs, and switches to inputs, I was able to exercise the system and verify operation.

Port Breakdown

The third thing to do is review PC port usage. The base port address is where data is written. (With a bi-directional port, data may also be read from that address. Old I/O cards like mine are not bi-directional.) The base address plus one is the status register of the port. The upper five bits of it have the meanings shown in Fig. 2A. The base address plus two is the control register, which breaks down as shown in Fig. 2B.

When used to drive a printer, various bits in the status port are used to indicate things like printer error, paper out, etc.

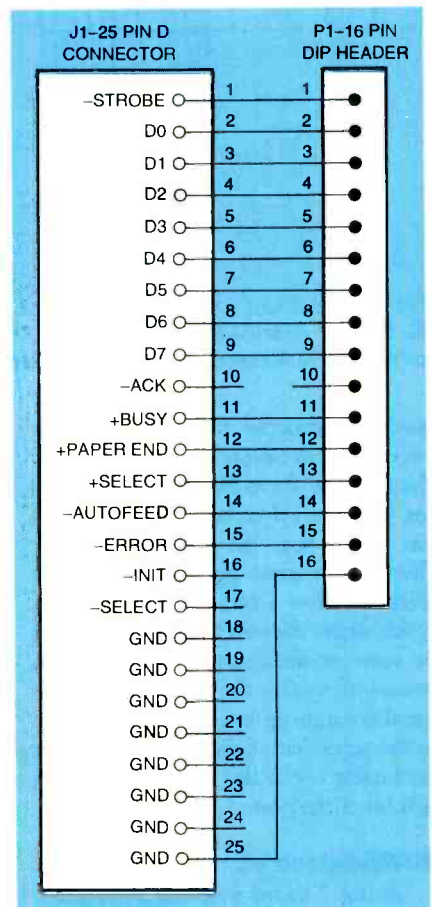

FIG. 1—WIRING DIAGRAM for the test jig. Connect a 16-pin DIP header to a 25-pin D connector to access the data bits, the strobe output, and the busy input. Unused pins may be used for other control and status lines.

And various bits in the control register can be used to tell the printer things like initialize or here's a data byte. Of course, when not driving a printer, both status and control bits can be used to mean anything you want them to mean.

DOS-Based I/O

Listing 1 shows a quick and dirty

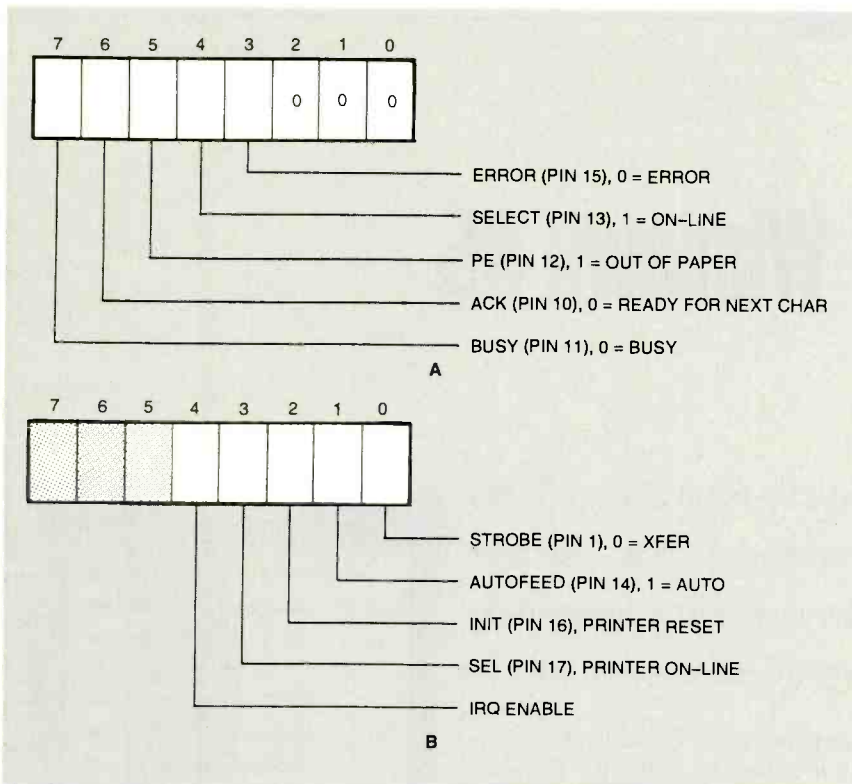

FIG. 2—THE STANDARD PC PARALLEL PORT has status (a) and control (b) registers located at base address + 1 and base address + 2, respectively.

QuickBasic program that simply writes a 1 to each bit in turn of the specified port. The software works like this: As it initializes, it writes a 1 to bit 0 of the control port. That puts the strobe line high. Then the program goes into a loop in which it writes a bit, checks for a key-stroke, writes the next bit, and so on, until the user presses Escape. As part of the process of writing the data bit, the routine also toggle the strobe line. So if I lean on the space bar as the program runs, it continually cycles the LEDs attached to each bit of the port.

WIN95-Based I/O

Listing 2 shows key routines from a Delphi program that does approximately the same thing in Windows 95. A screen shot of the program appears in Fig. 3. The program accommodates three user-initiated actions: write a value to the data port, write a value to the control port, and start a cycle mode that rotates a 1 through all bits of the port automatically. In those routines, I didn't bother to cycle the strobe bit of the control register, but by now you know how to do that yourself.

The Delphi code is little more than a wrapper around the same type of assembly language code as would be used in a

real application or driver. The key routines are PortDataOut, PortControlOut, PortStatusIn, and PortControlIn. Each of these makes use of Delphi's powerful built-in assembler. You'll notice that the functions don't appear to return any results. That's because when using the asm directive, functions automatically return the CPU's A register (or whatever portion of it you happen to be using). In all cases, the in and out instructions use the CPU's DX register as an index to the desired port. The port addresses are defined by constants, and hard-coded in the routines. A real application would pass the port addresses as parameters to the I/O routines, but for demonstration purposes, this was the simplest approach.

There is one big problem with the Delphi approach as written. It assumes that it has exclusive access to the port, and that is not a good assumption to make in a multitasking operating system. A real application would attempt to claim the resource before using it.

Incidentally, this approach won't work at all under NT because there is no way a user-mode application can access I/O ports directly; it must be done through a device driver. (If you're interested in the NT approach, a good starting point is the article, "Direct Port I/O

LISTING 1

```
' Parallel port test utility
' Ingeneering Inc.
' jkh 1/31/97

'PortBase = &H378      ' normally lpt1
PortBase = &H278      ' normally lpt2
PortData = PortBase
PortStatus = PortBase + 1
PortControl = PortBase + 2

DIM lc AS STRING      ' loop control string
DIM sb AS INTEGER     ' status byte
DIM co AS INTEGER     ' control byte

OUT PortControl, 1    ' ensure strobe is high

lc = ""
i = -1
WHILE lc <> CHR$(27)  ' Esc
  i = i + 1
  IF i > 7 THEN i = 0
  OUT PortData, 2 ^ i
  OUT PortControl, 0  ' enable to use strobe
  OUT PortControl, 1 ' enable to use strobe
  sb = INP(PortStatus)
  co = INP(PortControl)
  PRINT "Data="; HEX$(2 ^ i); " Status=";
  HEX$(sb); " Control="; HEX$(co)
  lc = INPUT$(1)
WEND
```

END

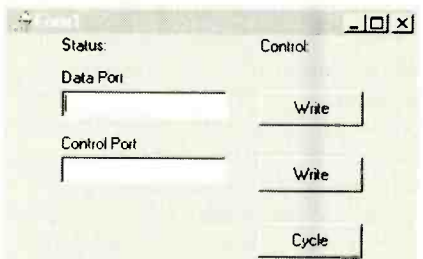

FIG. 3—PORT I/O FROM DELPHI: The test program writes to the data and control ports, and reads and displays the status and control ports after every write. The Cycle button shifts a logic high through the eight data bits of the port.

and Windows NT," on page 14 of the May 1996 issue of *Dr. Dobbs' Journal*.

HPC vs. Subnotebook

The latest in computer-related gadgetry is the so-called Handheld PC. Most have a Windows 95 look and feel, proprietary hardware and software architectures, and cost \$500 and up. To get a complete setup with modem, memory, and PC attachment, you'll probably spend close to a thousand. And you won't be able to run much software.

continued on page 69

For today's problems that need to be solved yesterday.



The world's
most powerful
handheld scope.

When equipment goes down you need to fix it in a hurry, or get used to people looking over your shoulder. Fortunately, the 200 MHz THS730A handheld scope has the power to help you quickly solve the most complex design and troubleshooting problems. Its IsolatedChannel™ architecture lets you make floating measurements safely. It's the only handheld scope to offer a 1 GS/s sampling rate on all channels. And it has advanced triggers for delay, pulse and video. For more information, please contact your Tektronix distributor or call 1-800-479-4490, action code 730, or visit us at www.tek.com

Buy the THS730A before July 31, 1997, and get a free Wavestar software set. That's a \$295* value! Call today for information.

Tektronix

RETAILERS THAT SELL OUR MAGAZINE MONTHLY

Alaska

Frigid North Co.
1207 W. 36th Avenue
Anchorage, AK 99503

California

California Electronics
221 N. Johnson Ave.
El Cajon, CA 90202

Ford Electronics
8431 Commonwealth Avenue
Buena Park, CA 90621

All Electronics
14928 Oxnard Street
Van Nuys, CA 91411

Gateway Electronics of CA
9222 Chesapeake Drive
San Diego, CA 92123

Mac's Electronics
191 South "E" Street
San Bernardino, CA 92401

Electronics Warehouse
2691 Main Street
Riverside, CA 92501

Orvac Electronics
1645 E Orangethorpe Ave.
Fullerton, CA 92631

Sav-On Electronics
13225 Harbor Blvd.
Garden Grove, CA 92643

JK Electronics
6395 Westminster Blvd.
Westminster, CA 92683

Marvac Dow Electronics
980 S. A Street
Oxnard, CA 93030

Kandarian Electronics
1101 19th Street
Bakersfield, CA 93301

Whitcomm Electronics
105 W. Dakota #106
Clovis, CA 93612

Marvac Dow Electronics
265-B Reservation Road
Marina, CA 93933

Minuteman Electronics
37111 Post St., Suite 1
Fremont, CA 94536

HCS Electronics
6819 S. Redwood Drive
Cotati, CA 94931

Halted Specialties Co.
3500 Ryder Street
Santa Clara, CA 95051

Metro Electronics
1831 J Street
Sacramento, CA 95814

HSC Electronics
4837 Amber Lane
Sacramento, CA 95841

Colorado

Gateway Electronics of CO
2525 Federal Blvd.
Denver, CO 80211

Centennial Electronics
2324 E. Bijou
Colorado Sps., CO 80909

Connecticut

Signal Electronics Supply
589 New Park Avenue
W. Hartford, CT 06110

Cables & Connectors
2198 Berlin Turnpike
Newington, CT 06111

Electronic Service Prod.
437 Washington Avenue
North Haven, CT 06473

Georgia

Norman's Electronics, Inc.
3653 Clairmont Road
Chamblee, GA 30341

Illinois

Tri State Elex
200 W. Northwest Hwy.
Mt. Prospect, IL 60056

Maryland

Mark Elec. Supply Inc.
5015 Herzel Place
Beltsville, MD 20705

Amateur Radio Center
1117 West 36th Street
Baltimore, MD 21211

Massachusetts

U-Do-It Electronics
40 Franklin Street
Needham, MA 02194

Michigan

Purchase Radio Supply
327 East Hoover Avenue
Ann Arbor, MI 48104

Norwest Electronics
33760 Plymouth Road
Livonia, MI 48150

The Elec. Connection
37387 Ford Road
Westland, MI 48185

Elec. Parts Specialists
711 Kelso Street
Flint, MI 48506

Minnesota

Acme Electronics
224 Washington Avenue N.
Minneapolis, MN 55401

Missouri

Gateway Electronics Of MO
8123-25 Page Blvd.
St. Louis, MO 63130

William Elec & Ind Supply
803 Davis Blvd.
Sikeston, MO 63801

New Jersey

Lashen Electronics Inc.
21 Broadway
Denville, NJ 07834

New York

Sylvan Wellington Co.
269 Canal Street
New York, NY 10013

R&E Electronics
4991 Rt. 209
Accord, NY 12404

Unicorn Electronics
Valley Plaza
Johnson City, NY 13790

Ohio

Philcap Electronic Suppliers
275 E. Market Street
Akron, OH 44308

Oregon

Norvac Electronics
7940 SW Nimbus Avenue
Beaverton, OR 97005

Pennsylvania

Business & Computer Bookstore
213 N. Easton Road
Willow Grove, PA 19090

Texas

Mouser Electronics
2401 Hwy. 287 N
Mansfield, TX 76063

Tanner Electronics
1301 W Beltline
Carrollton, TX 75006

Electronic Parts Outlet
3753 B Fondren
Houston, TX 77063

GMD Electronics
2625 S. Loop Hwy.
Alvin, TX 77511

Electronic Parts Outlet
17318 Highway 3
Webster, TX 77598

Washington

Amateur Radio Supply Co.
5963 Corson Ave., Ste 140
Seattle, WA 98108

If you'd like to sell our magazine in your store,
please circle 210 on Free Information Card.

WILLIAM SHEETS K2MQJ AND
RUDOLF F. GRAF KA2CWL

Low-power FM transmitters have become a popular hobby item in recent years. They are usually free-running RF oscillators that are frequency-modulated with an audio signal and are used in many applications from wireless microphones to listening devices to small home-entertainment extenders that let you listen to your home stereo anywhere in your house or yard through a portable radio. Stereo operation is also possible, with a number of chips developed for just such a device. However, recent advances in radio technology have brought out some problems in those devices that were not important before.

Digitally-tuned receivers are commonplace nowadays. Those receivers are always exactly on frequency, making tuning to a desired station very simple. The traditional analog "slide-rule" dial has largely disappeared from the higher-end FM receivers, replaced by LCD or LED readouts. Automatic frequency control and fine-tuning adjustments are no longer needed, as such units cannot be tuned off channel. Any received signals must be exactly on frequency. If it is not, either no signal will be received or the signal will be distorted. Of course, that is no problem for commercial FM stations. Their frequencies must be crystal-controlled and held to extremely close tolerances. However, for the user of a simple low-power transmitter, that could be a problem because frequency drift is a fact of life for those circuits.

It is hard to hold simple LC oscillators to a stability much better than 0.1% over a reasonable temperature and supply-voltage range. At 100 MHz, the middle of the FM-broadcast band, that tolerance becomes a drift of 100 kHz. An analog-tuned FM receiver has no problem receiving the signal as it drifts because the AFC circuit automatically retunes the receiver as needed. A digitally-tuned receiver with frequency-synthesized tuning using a phase-locked loop (PLL) circuit cannot do that without special circuitry. Commercial FM receivers

BUILD THIS FM-STEREO TRANSMITTER

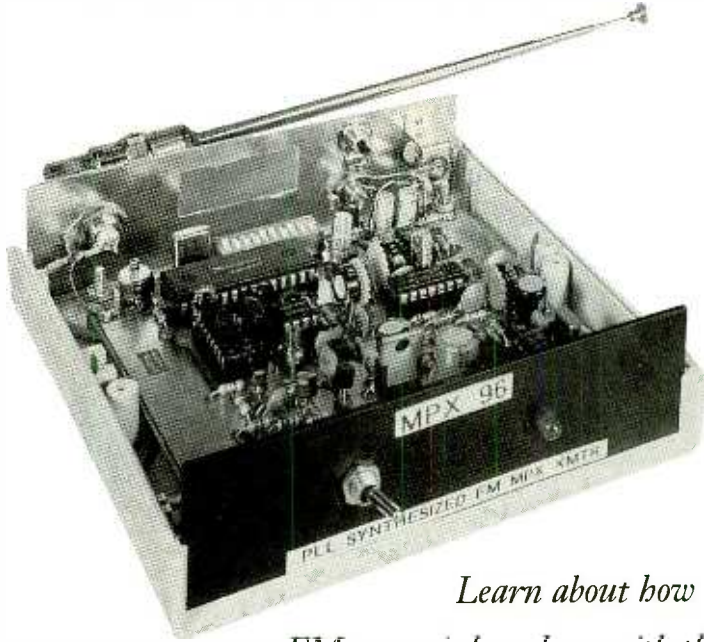

*Learn about how
FM stereo is broadcast with this
easy-to-build project—an FM transmitter that can
extend your home stereo system anywhere on your property.*

have no need to do that because of the stability of commercial FM radio stations. Also, the FM band is crowded with many signals in most populated areas, and a free or unoccupied channel is rare at times. Therefore, as the low-power FM transmitter drifts, it runs into interference from adjacent channels.

The solution to that problem is to make the low-power transmitter crystal controlled. However, that is

not simple because the 75-KHz frequency deviation needed for FM-broadcast work cannot easily be obtained from simple crystal oscillators. It is even difficult to get a tenth of that deviation (7.5 kHz) and still keep the audio distortion below 1%. Commercial FM transmitters use frequency-multiplier stages and mixers, starting at a low frequency, multiplying up, heterodyning down, and multiplying up again to achieve a large multiplication factor. In that way, it is possible to get the 75-kHz deviation from a lower-frequency oscillator with a very tight tolerance. That traditional method requires a lot of circuitry, and is impractical, complex, and expensive for the hobbyist wishing to experiment with low-power, physically small, and simple FM transmitters.

Fortunately, there is another

Warning!

The publisher makes no representations as to the legality of constructing and/or using the FM Stereo Transmitter referred to in this article. The construction and/or use of the transmitter described in this article may violate federal and/or state law. Readers are advised to obtain independent advice as to the propriety of its construction and the use thereof based upon their individual circumstances and jurisdiction.

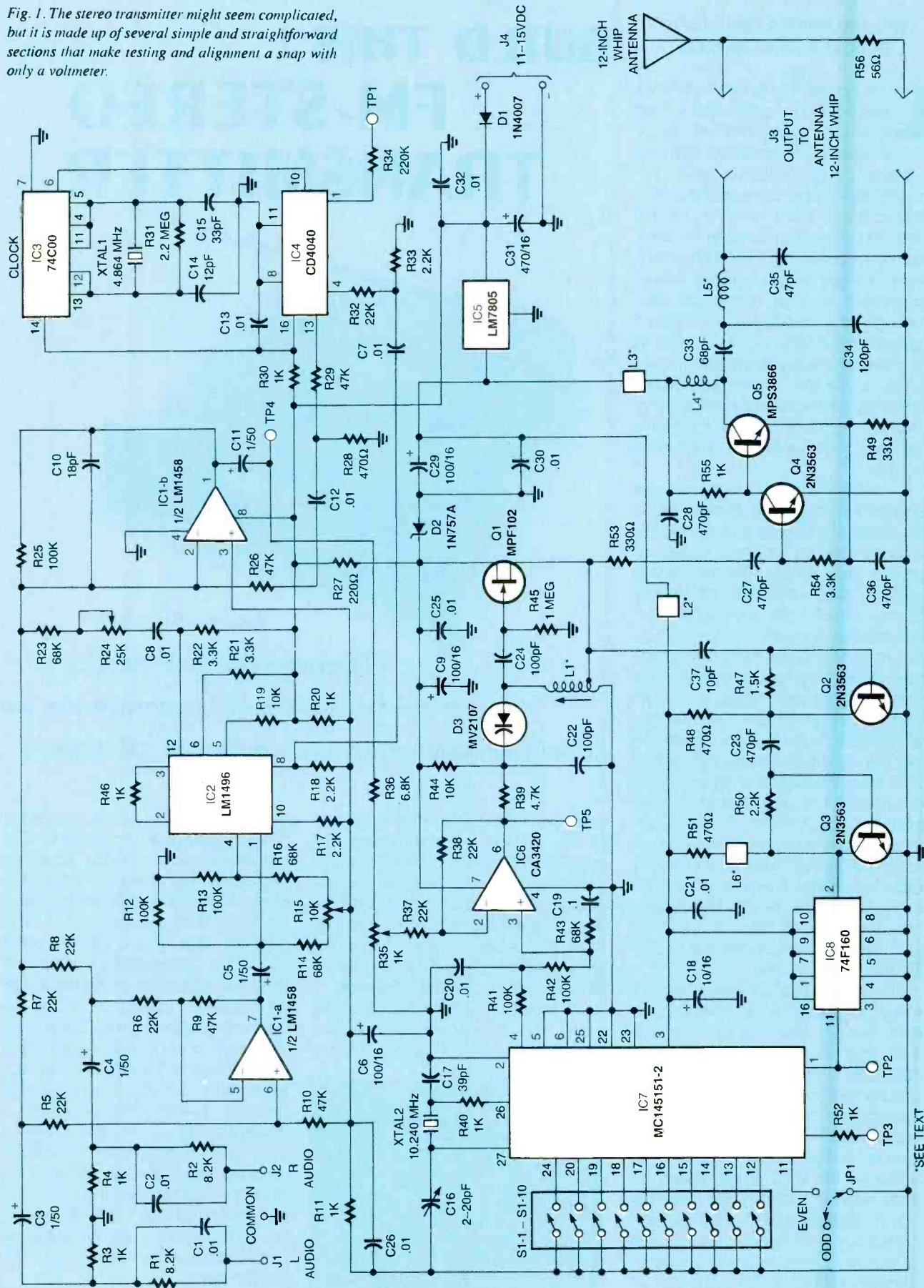

Fig. 1. The stereo transmitter might seem complicated, but it is made up of several simple and straightforward sections that make testing and alignment a snap with only a voltmeter.

approach made possible by the use of modern digital ICs. This article will describe a simple low-power FM-stereo transmitter using phase-locked loop techniques along with a few digital ICs and analog op-amps to produce a clean, stable, broadcast-quality FM-stereo signal. It is a complete FM-stereo audio link operating in the standard FM broadcast band. It can be operated over a range of 76–108 MHz. That range will work in both the North American domestic FM and the 76–88 MHz frequency range used in the Far East. A channel spacing of 100 kHz assures coverage of all FM frequencies worldwide. Both the FM-carrier frequency and the multiplex-pilot frequencies are crystal controlled, eliminating the drift common with LC oscillators. That permits use of this unit with the digital receivers that you find today.

Frequency selection is done by setting a ten-position DIP switch with a binary code corresponding to the desired transmitter frequency. That frequency can be any unused FM channel in your area. Once the frequency is set, the transmitter will stay on that channel, as it is phase locked to an internal crystal oscillator. Audio input can be any line-level source of 0.5- to 1-volt rms, and can be either a stereo signal or two individual monophonic signals. An on-board audio-tone generator, set to 1200 Hz, makes setting the transmitter and receiver easy. All seven IC devices in the transmitter are readily available. Circuit setup is very simple, with only a volt-ohmmeter needed. A single 12- to 15-volt DC negative-ground supply is needed to power the transmitter. With a current drain of 120 milliamps, a simple battery pack can be used as a power source. The RF output is about 10 milliwatts into a 50-ohm load (0.7V rms). At that level, the transmitter complies with US requirements for unlicensed transmitters when used with a 12-inch antenna and a 56-ohm shunt resistor. For use outside the USA, the output power can be increased to 150 milliwatts with a simple circuit change.

There are many ways to use the

transmitter. You can listen to your CD player or tape deck on a pocket radio in a different room than that where your audio equipment is located. You can even be outside the house, in the garage, in the workshop, or on the deck or patio while listening. A private or in-house broadcast systems for schools, real-estate offices, health clubs, stores, offices, museums, etc. could be set up. For entertainment of groups where a second language is spoken, two languages can be carried—one on each stereo channel. Using small pocket-stereo receivers, audience members can choose which language they hear by choosing whether they listen to the left channel or right channel.

A Short History. An early stereo transmitter project was published in the March 1988 issue of **Radio-Electronics**. That project also used several ICs to generate the carrier frequency. Soon after that project appeared, the BA1404/BA1405 IC came on the scene, greatly simplifying the task of building an FM-stereo transmitter. The BA1405 was similar to the BA1404, but had no integrated RF section. Originally meant to play portable CD players through FM-stereo auto radios, those ICs were useful for making a simple stereo transmitter. The BA1404 had poor RF stability and taught little about FM-stereo circuit operation to the experimenter. It also had the disadvantage of requiring a low supply voltage (below 3 volts) and required a fragile 38-kHz crystal.

The transmitter presented here is a simplified version of the earlier circuit, adding some improvements and eliminating several setup adjustments. Two IC devices now handle multiplex-signal generation, and a crystal-controlled design replaces the three large coils originally used. The fragile 38-kHz crystal used by the BA1404 for the pilot and subcarrier frequencies has been replaced by a rugged 5-MHz type, and two common CMOS ICs generate the 38-kHz and 19-kHz signals. As an extra bonus, a 1.2-kHz audio signal is developed in one of the ICs for test purposes. The total cost is low and, unlike the BA1404/BA1405

approach, all of the multiplex-signal components are available for study and experimentation.

Circuit Operation. The transmitter uses eight IC devices and five transistors to create a complete phase-locked-loop synthesized FM stereo transmitter. The transmitter can be divided into several sections. Those sections are the audio generator, multiplex (MPX) generator, clock generator, phase-locked loop, and output amplifier. The schematic diagram in Fig. 1 will make the following discussion easier to understand.

The audio section is made up of IC1, an LM1458 dual op-amp, and balanced modulator IC2. Line-level audio inputs connected to both J1 and J2 are fed to two R-C pre-emphasis networks made up of R1/C1/R3 and R2/C2/R4. Those networks boost frequencies above 2000 Hz for a better signal-to-noise ratio. The same technique is used in FM broadcasting. Coupling capacitors C3 and C4 pass those signals to a matrixing circuit consisting of R7, R8, and IC1-a and associated components R5, R6, R9, R10, and C5. The left and right inputs are combined to form a sum of the left and right inputs (L+R) by R7 and R8. That signal is passed to the input of IC1-b, where it is combined with two other signals. One of those signals is the audio subcarrier containing the difference of the two audio inputs (L-R). Note that if the two audio inputs are identical, the difference signal is zero.

Op-amp IC1-a is configured as a differential amplifier with a gain of about two. The left audio input is fed to the non-inverting input through R5 and R10. A network consisting of R11, R20, C6, and C26 provides a fixed bias of half the supply voltage to bias both the IC1-a and IC1-b inputs. That avoids the need for a split power supply. The right audio input is fed to the inverting input of IC1-a through R6. The ratio of R9 to R6 sets the gain. Resistors R5, R6, R9, and R10 are chosen so that equal gain is obtained for both audio inputs. Since the right input is inverted in IC1-b, the output of IC1-b is proportional to the difference of the audio inputs.

The two combined audio signals

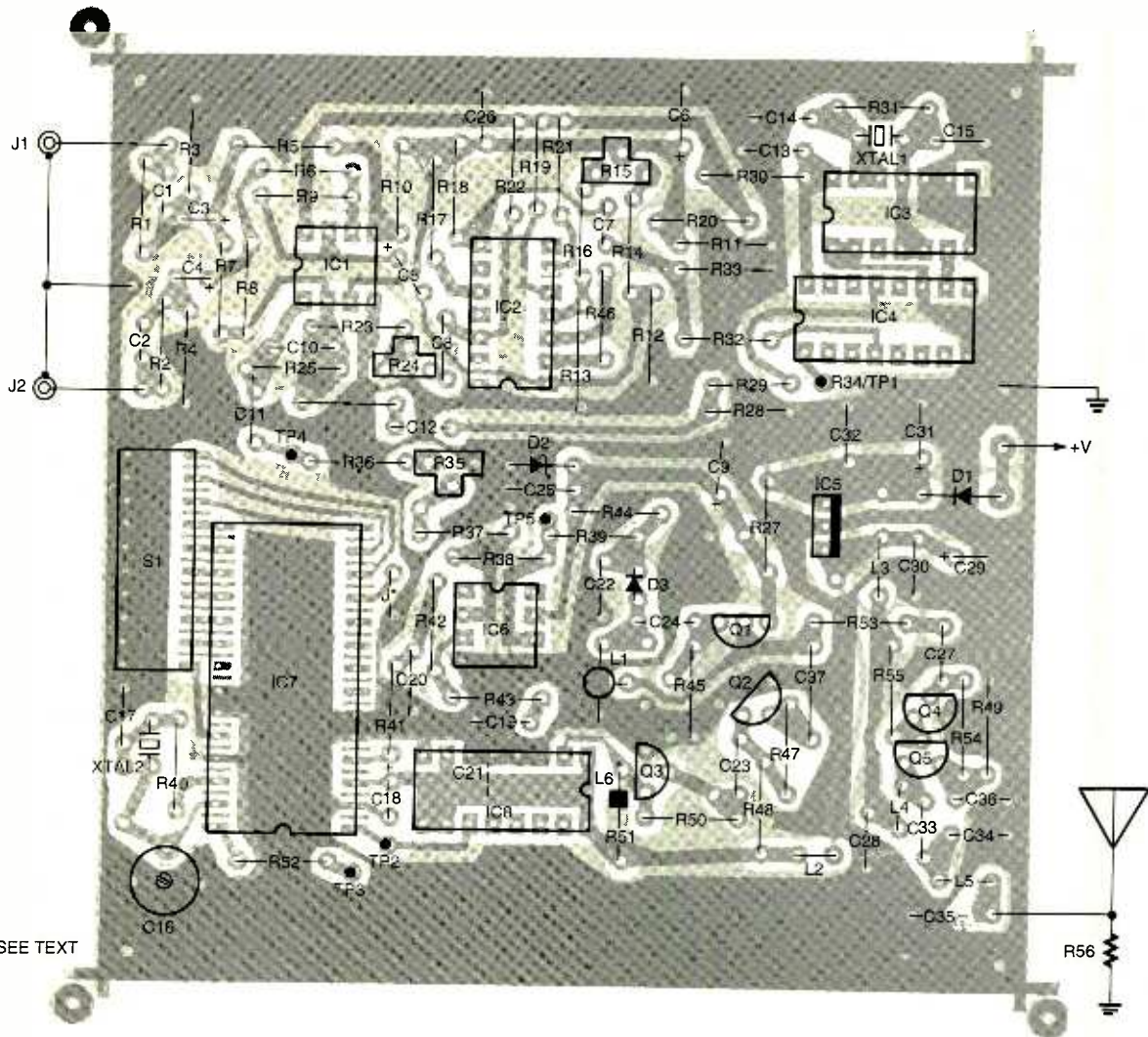

Fig. 2. The transmitter is easily built on a single PC board. A single surface-mount capacitor is soldered to the bottom side of the board. Be sure to solder the component leads on both sides of the board where pads are provided on the component side.

(sum and difference) cannot be combined at this point as there would be no way of keeping the two signals separated. The way to solve that problem is to first modulate the difference signal onto a subcarrier signal that is well above the upper end of the audio band, which extends from about 20 Hz to about 15 kHz. That is done by producing a double-sideband signal at 38 kHz, and then modulating it with the L-R audio signal, which also has audio components from 20 Hz to 15 kHz. A double-sideband signal having sum and difference components of the 38-kHz subcarrier and the L-R audio is produced. Since the L-R signal has frequencies up to 15 kHz, the subcarrier will have components from 38 kHz \pm 15 kHz, or from 23 to 53 kHz. Because

the 38-kHz signal has no information, it is suppressed, leaving only the sum and difference sidebands, which have the L-R information. The subcarrier is produced by IC2, an LM1496N balanced modulator. That device will produce a double-sideband signal at pin 6 or 12 that is the product of the modulation signal at pin 1 or 4 and the unmodulated (continuous wave or CW) subcarrier signal at pin 8 or 10. A bias network for IC2 is formed by R12 through R19, R21, and R22. Potentiometer R15 is provided for exact balancing of the currents through the internal circuitry of IC2. When properly adjusted, the 38-kHz subcarrier signal fed to inputs (pins 8 or 10) can be completely removed from the modulator outputs (pins 6 and 12), leaving only

the sum and difference products of the L-R input at pins 1 and 4 and the subcarrier at pins 8 or 10. That is exactly what is wanted.

Only one input pin is used for the audio and 38-kHz subcarrier as the differential input and output capability is not needed here. The output at pin 12 is fed to multiplex amplifier IC2-b through C8, level control R24, and R23. The balanced modulator has a gain of about two and the differential amplifier has a gain of two, giving an overall gain of four times in the L-R channel. In order to keep the gain of the L+R and L-R signals equal, the combined resistance of R23 and R24 should be four times the value R7 or R8. Because of tolerances in the resistors and individual differences in IC2, R24 is adjustable in order to

allow the gain of those signals to be set equal to each other. The gain of IC2 is set by R46 to about two.

In order for the receiver to recover the L-R information, a reference is required so that the recovered L-R information will have the correct phase and frequency content. It would be difficult to try to filter that from the subcarrier signal, which might have L-R audio components as low as 20 Hz. There is, however, an easier way to do that.

A 20-Hz audio signal would produce both 37,980 Hz and 38,020 Hz subcarrier components, which are very close to 38 kHz and are easily separated from the 38-kHz carrier without the need of an expensive filter. A pilot signal at half that frequency, or 19 kHz, is used as a reference instead. That frequency fits into the composite signal quite well, being halfway between the L+R audio maximum frequency of 15 kHz and the lower limit of the L-R at 23 kHz. The pilot signal is supplied by the clock-generator circuit, which will be discussed shortly. The pilot signal is fed to IC1-b through coupling capacitor C12 and R26. It has a level about one quarter of the peak of either the L+R or L-R signals. In addition, it is used by most stereo receivers to activate both their stereo-decoding circuit and their stereo-indicator LED. If a monophonic receiver is tuned to the stereo signal, only the L+R portion would be used. Any frequencies above the audio spectrum are rejected, which include the L-R and the pilot signals. The L+R signal is, of course, the combination of the left and right stereo channels. That ensures compatibility between stereo broadcasts and mono receivers, just as black-and-white TV sets can receive color broadcasts and still display a black-and-white version of the color picture.

Three signals are present at the input of IC1-b: the L+R signal, the L-R subcarrier signal, and the pilot signal. Those signals are added together in IC1-b and the composite signal appears at the output. The overall gain is set by R25 to about four, and C10 restricts the bandwidth of the stage to less than 100 kHz at 3 dB down. The composite signal is coupled by C11 to TP4,

R36, and deviation control R35. The deviation control is used to set the level of the composite signal to the FM modulator, and R36 limits the maximum level in order to avoid overdeviation.

The clock-generator circuit consists of IC3, IC4, and their associated components. Its purpose is to generate a stable 38-kHz subcarrier, a 19-kHz pilot signal, and a 1.2-kHz

up to 4096. An output is available at each division stage. Thus, a 38-kHz signal ($4864 \div 128$), a 19 kHz signal ($4864 \div 256$), and a 1187.5 Hz signal ($4864 \div 4096$) are produced and are all in phase with respect to each other. The outputs are reduced to lower levels by R29, R28, R32, R33, and R34 as the nominal 7-to 8-volt signals are far more than needed. The power supply for IC3 and IC4 is reduced to about 8 volts by R30 and C13. Those components also decouple the supply line from any noise generated by those ICs. Using a rugged and inexpensive 5-MHz-range fundamental crystal and a divider circuit gets rid of the fragile and expensive 38-kHz crystal used in other approaches, such as the BA1404, and supplies a 1.2-kHz audio tone for setup purposes at no extra cost.

The phase-locked-loop (PLL) synthesizer section uses an MC145151-2 chip. That chip contains a reference oscillator, a reference divider, a charge-pump phase detector, and a variable divider that can be set for division ratios from 3 to 16,384. The reference divider is programmed by grounding control pins to generate various division ratios. For our needs, the reference divider is set to divide by 1024 so that a standard 10.240-MHz crystal will provide a reference frequency of 10 kHz. That sets the resolution of the synthesizer. The maximum input frequency that the chip can directly handle is around 12 MHz.

The FM broadcast band has channels at 200-kHz spacing. In the USA and Canada, they start at 88.1 MHz and increment in 200 kHz steps (i.e. 88.3, 88.5, 88.7) to 107.9 MHz. In many parts of the world, channels with even spacing (i.e. 90.0, 90.2, 90.4) are common. In some parts of the Far East, frequencies as low as 76 MHz are used. The transmitter circuit will cover all frequencies, but in the interest of best synthesizer performance, cost limitations, and circuit simplicity, the tuning range has been restricted to about 8 MHz without need for the VCO to be reset—that tradeoff is well worth the convenience of having just one simple adjustment. The synthesizer supports all channels between 76 and 108 MHz in 100 kHz increments.

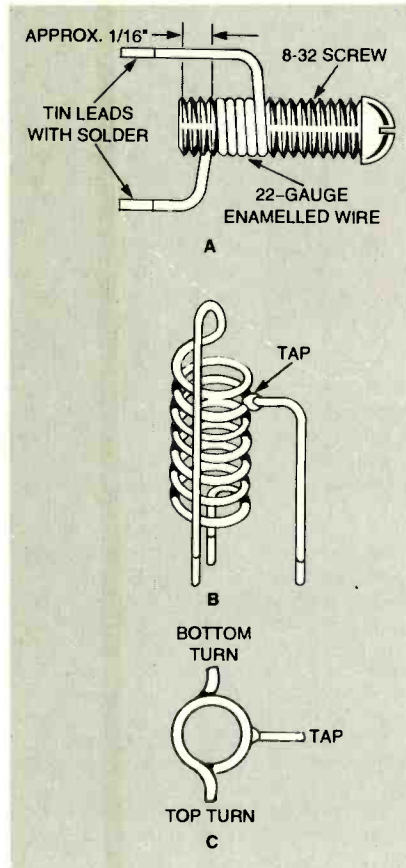

Fig. 3. Making L1 is simplified by using an 8-32 screw as a winding form (A). Be sure the screw is steel instead of brass, or you might solder the coil to the screw when attaching the tap (B). After the coil is installed in the PC board and the screw removed, it should look like (C) when viewed from overhead.

audio signal for testing and alignment purposes. For stability, it is crystal controlled. A NAND gate, IC3-a, is connected as an inverter, and is biased by R31 so it will initially act as an amplifier. A feedback network consisting of XTAL1 and capacitors C14 and C15 let the circuit oscillate at 4.864 MHz. Output from IC3-a is fed to IC3-b to buffer the clock signal. The buffered output drives IC4, a 12-stage counter and divider, which divides the clock signal by

Table 1

Frequency in MHz		S1 Settings									
Even Channels	Odd Channels	1	2	3	4	5	6	7	8	9	10
88.0	88.1	on	on	on	off	off	off	on	off	off	on
88.2	88.3	off	on	on	off	off	off	on	off	off	on
88.4	88.5	on	off	on	off	off	off	on	off	off	on
88.6	88.7	off	off	on	off	off	off	on	off	off	on
88.8	88.9	on	on	off	off	off	off	on	off	off	on
89.0	89.1	off	on	off	off	off	off	on	off	off	on
89.2	89.3	on	off	off	off	off	off	on	off	off	on
89.4	89.5	off	off	off	off	off	off	on	off	off	on
89.6	89.7	on	on	on	on	on	on	off	off	off	on
89.8	89.9	off	on	on	on	on	on	off	off	off	on
90.0	90.1	on	off	on	on	on	on	off	off	off	on
90.2	90.3	off	off	on	on	on	on	off	off	off	on
90.4	90.5	on	on	off	on	on	on	off	off	off	on
90.6	90.7	off	on	off	on	on	on	off	off	off	on
90.8	90.9	on	off	off	on	on	on	off	off	off	on
91.0	91.1	off	off	off	on	on	on	off	off	off	on
91.2	91.3	on	on	on	off	on	on	off	off	off	on
91.4	91.5	off	on	on	off	on	on	off	off	off	on
91.6	91.7	on	off	on	off	on	on	off	off	off	on
91.8	91.9	off	off	on	off	on	on	off	off	off	on
92.0	92.1	on	on	off	off	on	on	off	off	off	on
92.2	92.3	off	on	off	off	on	on	off	off	off	on
92.4	92.5	on	off	off	off	on	on	off	off	off	on
92.6	92.7	off	off	off	off	on	on	off	off	off	on
92.8	92.9	on	on	on	on	off	on	off	off	off	on
93.0	93.1	off	on	on	on	off	on	off	off	off	on
93.2	93.3	on	off	on	on	off	on	off	off	off	on
93.4	93.5	off	off	on	on	off	on	off	off	off	on
93.6	93.7	on	on	off	on	off	on	off	off	off	on
93.8	93.9	off	on	off	on	off	on	off	off	off	on
96.0	96.1	on	on	on	on	on	off	off	off	off	on
98.0	98.1	on	off	on	off	on	off	off	off	off	on
100.0	100.1	on	on	off	on	off	off	off	off	off	on
102.0	102.1	on	off	off	off	off	off	off	off	off	on
104.0	104.1	on	on	on	off	on	on	on	on	on	off
106.0	106.1	on	off	on	on	off	on	on	on	on	off
107.8	107.9	off	off	on	off	off	on	on	on	on	off
Frequencies outside US/Canada											
76.0	76.1	on	on	off	off	off	off	off	on	off	on
80.0	80.1	on	on	on	on	off	on	on	off	off	on
84.0	84.1	on	on	off	on	on	off	on	off	off	on

12 MHz. IC8, a 74F160ACP prescaler, is used to divide the VCO frequency (76-108 MHz) by ten. The synthesizer will thus see 7.6 to 10.8 MHz in 10 kHz steps—one tenth of the transmitter frequency. The PLL phase detector is buffered by IC6, and provides a very high impedance for the sample-and-hold circuit, minimizing 10-kHz reference-frequency sidebands, and allowing smaller capacitors to be used in the compensation network. It also provides an easy method for injecting an audio signal into the VCO for directly modulating the carrier frequency. A voltage-controlled oscillator built around Q1 feeds buffer amplifier Q2/Q3 to interface with the prescaler IC8 and drive output buffer amplifier Q4/Q5.

The PLL oscillator consists of Q1, L1, and D3. Oscillator frequency is set by L1, D3, and stray capacitance from Q1 and the circuit in general. Bias for Q1 is provided by R45 and D3. Any stray RF on the anode of D3 is shunted to ground by C22. The capacitance of D3 is set by a DC voltage from R44 and R39. Depending on the voltage and the tuning of L1, the frequency will be anywhere from 76 to 108 MHz.

The output of the oscillator (the source of Q1) is passed to amplifier stages Q2 and Q3 through C37. The Q2/Q3 amplifier is connected as a wideband-feedback stage with R47 and R48 for feedback and bias. The first stage output from Q2 is coupled by C23 to the base of Q3. The second stage is biased by R51 and R50. The signal appearing at the collector of Q3 is now strong enough to drive IC8, a 74F160 TTL decade counter.

A signal of one-tenth the input frequency appears at pin 11 of IC8, which is fed to the variable-programmable divider section of IC7. The actual division is set by S1 to divide between 760 and 1080, which is equal to the desired output frequency times ten. For example, if the desired frequency is 89.7 MHz, then the divide ratio will be set to 897 with S1. The internal variable divider will produce a signal to be fed to the phase detector at the transmitter frequency divided by 8970, since we have divided 10

In order to eliminate a microprocessor and display, the desired frequency is set by S1, an on-board ten-section DIP switch. The desired transmitter frequency is selected from Table 1, and the switches are set accordingly. Once the transmitter is set to a clear channel, it will usually be left alone. In most populated areas, there are relatively few clear channels and in some major cities in the US, they are very rare, so there is little need to often reset the transmitting frequency. Additionally, most low-power FM transmitters operate between 88 and 92 MHz,

so a microprocessor and display is overkill and relatively useless. Although the synthesizer can cover a wider range than 76 to 108 MHz, it has not been tested to those extremes. There is no reason that it shouldn't work down into the HF range (below 30 MHz) with suitable design changes in the loop-filter network, VCO, and output-buffer amplifier. Higher frequencies are best handled by using suitable frequency multipliers. Those modifications will not be discussed and are left to the experimenter.

Since IC7 will only handle about

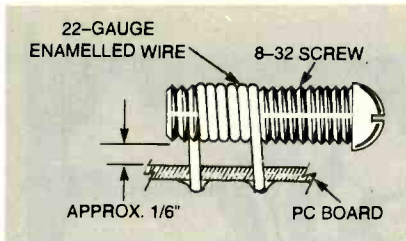

Fig. 4. Make L4 and L5 the same way as L1. Use 5 turns for L4 and 4 turns for L5.

times with IC8 and 897 times with the programmable divider. Meanwhile, the phase detector is fed a 10-kHz reference signal from an internal reference oscillator and divider that uses external components R40, C17, XTAL2, and C16. Those parts determine the oscillator frequency. The frequency is set exactly to 10,240 MHz by adjusting C16. An internal divider divides that frequency by 1024 to produce the 10-kHz reference. The accuracy of the output frequency depends on having an exact 10 kHz, which in turn needs an exact 10,240 MHz crystal-oscillator frequency.

The phase detector generates a voltage that depends on the relative phase difference between the reference and variable divider output waveforms. For example, suppose the divider output starts to lag the reference. That means that the VCO frequency is dropping. In that case, the phase detector produces positive going pulses and feeds them to the sample-and-hold network made up of R41, C20, R42, R43, and C19. The pulses charge C19 to a higher DC voltage. A high-impedance CMOS voltage amplifier consisting of IC6, R37, R38, R39, and R40 produces a positive-going output, which is fed to D3 through R39 and R44, causing the oscillator frequency to increase. The opposite happens if the VCO drifts higher, causing the divider output to lead the reference. The voltage on D3 is then lowered, and causes the VCO to lower its frequency. In that way, the VCO frequency is locked to the reference frequency. It will be exactly equal, in kilohertz, to one hundred times the programmed divide ratio. In the example, the divider is set to 897, so that the output frequency will be 100×897 or 89,700 kHz (89.7 MHz)

Frequency modulation is

accomplished by injecting the audio signal from the audio amplifier into IC6. Instead of being returned to ground, R37 is fed from potentiometer R35. The audio voltage is superimposed on the voltage to varactor D3. Since the bandwidth of the synthesizer loop is less than 20 Hz, the relatively high audio frequencies are not "corrected out," and as long as no DC component is injected (we're assuming symmetrical FM, which is the usual case), the variations in frequency under modulation are averaged out. The resulting modulation is clean and low in distortion since the VCO has a dynamic range of several volts and a 1-volt change produces about a 1-MHz frequency change. Therefore, only about 100 to 150 millivolts peak-to-peak of audio is needed for full modulation. The VCO is highly linear over such a small range.

A transmitter output signal of about 10 milliwatts is produced by amplifying a portion of the VCO signal. The signal from the VCO is fed through R53 and C27 to feedback pair Q4/Q5 and associated components R49, R54, R55, and C36. In that stage, the signal is amplified to the final output level and then fed to a matching network and harmonic filter (L4, C33, C34, L5, and C35). Output is at 50 ohms, and it is recommended to terminate the transmitter into a

load (R56) and use a simple 12-inch whip as an antenna to confine the signal to only that area needed. The supply line is decoupled by C28 and L3.

The supply voltage to IC6, IC7, and the output amplifier is regulated by varactor D3. The regulated supply line for IC7 and IC8 is further decoupled by L2, C18, and C21. Additional transient protection is provided by C29 and C30. The audio and clock sections IC1 through IC4 operate directly from 12 volts, while the VCO and IC6 are supplied with +9V from Zener regulator D2, R27, and decoupling capacitors C9 and C25. Input filtering of the 12-volt supply input is done by D1, C31, and C32. The supply voltage might vary from 11 to 15 volts in actual use. Exceeding the 15-volt level might cause damage, and less than 11 volts might result in the PLL not functioning. Also, excess noise on the DC supply line may cause the noise to be heard on the transmitted signal as interference and hum.

Building the Transmitter. Because of the RF signals involved, the transmitter should only be built on a PC board. If you wish to do so, artwork is provided in order to fabricate a PC board. A complete kit of all components can also be obtained from the source given in the Parts List.

With the exception of C21, all components are mounted on the

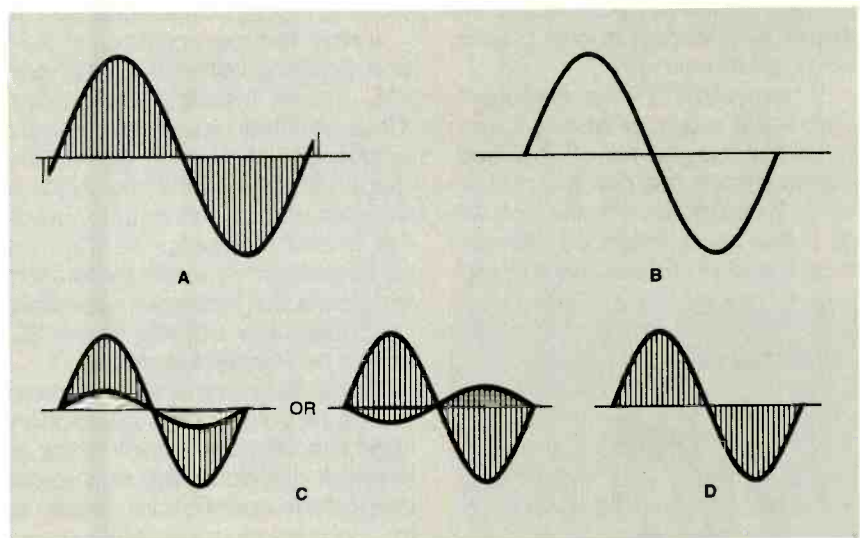

Fig. 6. If you have access to more sophisticated test equipment, you can perform more exact adjustments to the transmitter for optimum stereo separation and distortion. The waveform in (A) will be seen at TP4 with an audio tone applied to only one input channel. If the same tone is applied to both inputs, the output will look like (B). If R24 is misadjusted, the waveform will not be flat (C). Adjust R24 for the waveform in (D).

component side of the board. That capacitor, as well as the coils, will be mounted last. If you use the artwork to make your own board, the parts-placement diagram in Fig. 2 should be followed. Whenever possible, do not solder any leads until as many components as possible have been inserted in the board. The components should be mounted as tight as possible to the board in order to minimize any stray capacitance or noise pickup.

Start by inserting the resistors. As with any good construction technique, double check the values of all components before soldering them. A ferrite bead is placed over one lead of R51. The parts-placement diagram shows which lead of R51 gets the ferrite bead. Stand R34 vertical when installing it into its single hole. After soldering R34 in place, bend the unconnected lead into a "J"-shaped hook. That hook becomes TP1. Solder the bottom connections first, then solder any ground connections on the top side. You should only use rosin-core solder when making connections—a low-residue type is preferred. Acid-core solder should not be used on electronics under any circumstances.

The diodes should be installed next, followed by the capacitors. The polarity of the diodes and electrolytic capacitors should be carefully observed. Any polarized component installed backwards will cause a malfunction and possibly damage the circuitry.

When installing the transistors, reshape the leads as needed for a good fit. The shape of the case should match the direction shown in Fig. 2. Be careful with Q2 and Q3, as those parts might be different than the lead shapes seem to indi-

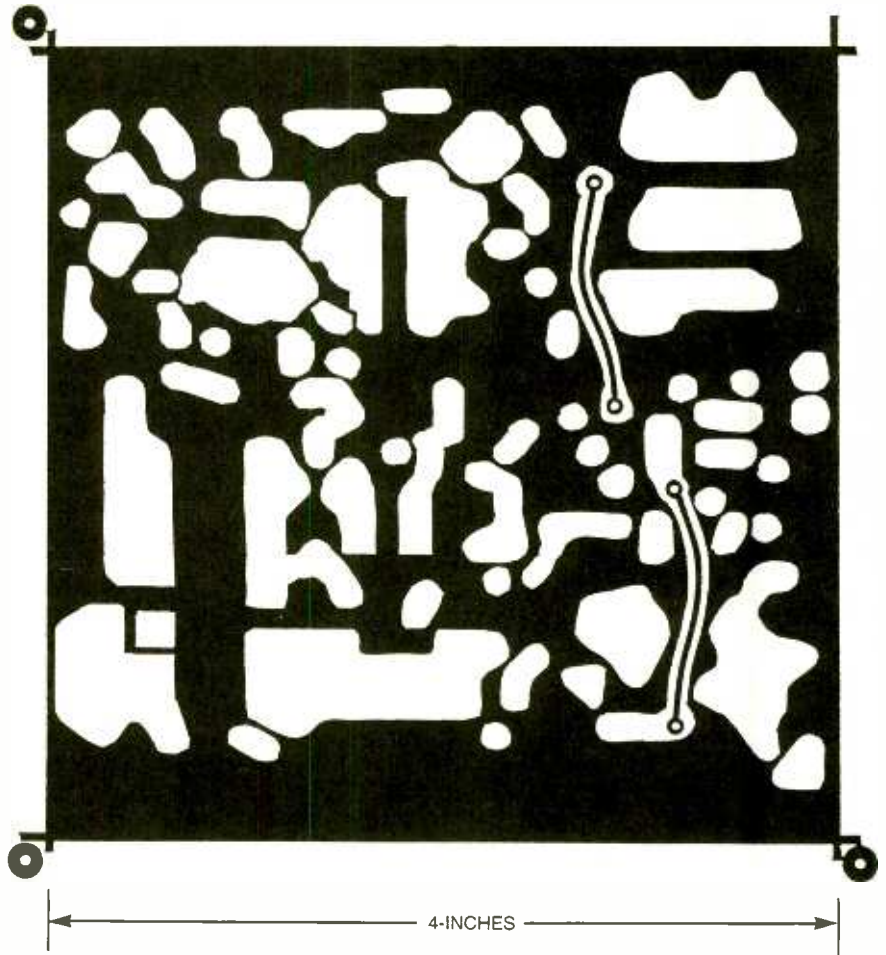

Here's the foil pattern for the component side of the transmitter. Using a double-sided board allows the inclusion of a ground plane that helps shield the RF circuitry.

cate. If Q2 and Q3 have preformed leads, straighten them with pliers in order to permit correct orientation.

Install trimmer capacitor C16 and potentiometers R15, R24, and R35. Before installing XTAL1 and XTAL2, trim their leads, using scissors, to a length of $\frac{3}{16}$ -inch. Do not use diagonal cutters—the mechanical snap produced can actually break the crystal elements. The ICs may be installed into sockets soldered to the board, but that is not necessary. Of course, the polarity of the ICs should be followed carefully.

Carefully check all work done so far for accuracy and orientation. Now trim all component leads to length if not done yet, and solder all bottom connections made so far. Do not plug up any unused holes yet.

Figure 3 illustrates how to make L1. Wind $6\frac{1}{2}$ turns of 22-gauge magnet wire onto the threads of an

8-32 screw. Shape the ends of the wire so that it looks like Fig. 3A. Scrape the enamel from the wire at a spot $1\frac{3}{4}$ turns from the top end (Fig. 3B). A 1-inch length of resistor lead is soldered to the coil at that spot. Using the screw as a handle, install L1 into the PC board and solder the connections. Be careful not to unsolder the tap connection when soldering the coil to the board. After the solder has cooled, remove the screw and replace it with a ferrite slug. The coil should look like Fig. 3C when viewed from above.

The same procedure is used to make L4 and L5. Coil L4 should be 5 turns and L5 will be 4 turns. Follow Fig. 4 when installing them in the PC board. After installing the coils, remove the screws. Those coils do not get any ferrite slugs.

Fabricate the ferrite-bead chokes L2 and L3 as shown in Fig. 5.

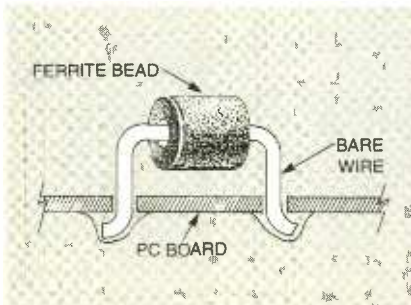
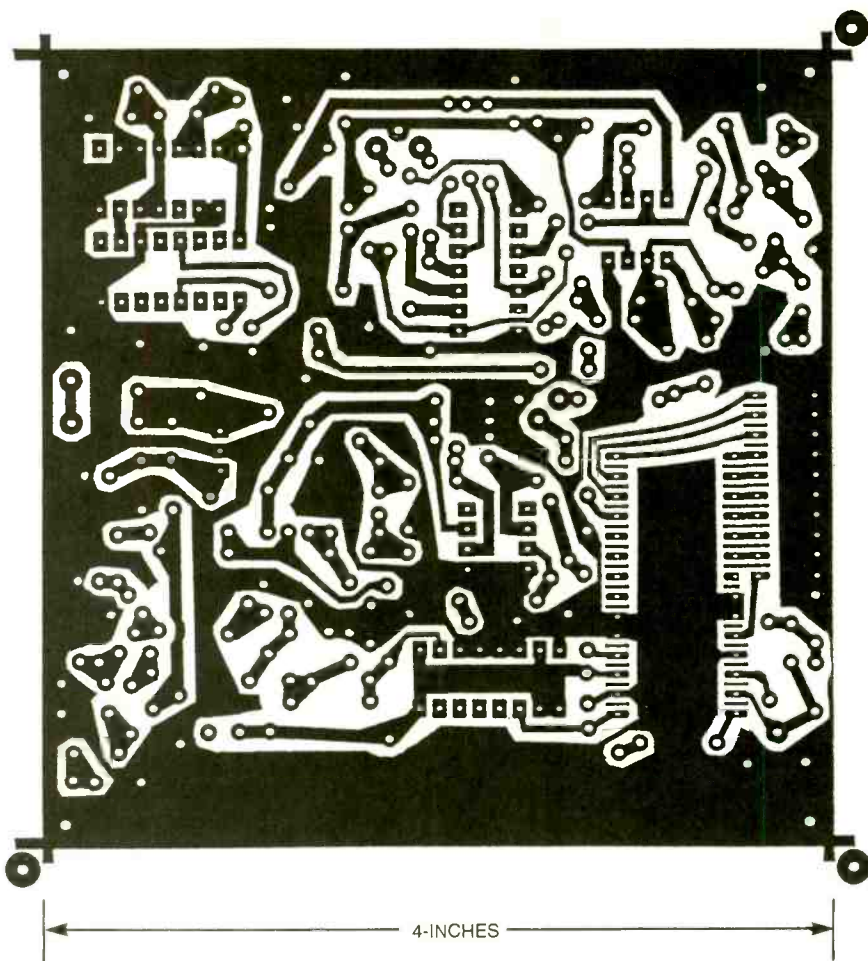

Fig. 5. The chokes for L2 and L3 are simply a length of scrap resistor lead with a ferrite bead.



Here's the foil pattern for the solder side of the transmitter. Be sure to align both patterns carefully when etching the board.

The chokes are simply wires passed through ferrite beads. The ferrite beads should be broadband types designed for VHF to UHF frequencies. Install the chokes into the PC board. Scrap resistor leads with one end bent into a small "J" hook similar to R34 can be used as TP2-TP5. Finally, install C21 on the underside of the PC board.

Carefully inspect all work so far. Look for solder shorts, poor joints, missing parts, incorrect part orientation or placement, etc. Once the board is built, you are ready to test your handiwork.

Testing the Transmitter. Setting up and testing the transmitter is simple and straightforward. An analog volt-ohmmeter with an input impedance of 20,000 ohms-per-volt or better is the only piece of test equipment needed. A digital volt-meter will also work, but an analog VOM is preferred. The power supply

should be well-regulated with a low-ripple, 13.2-volt DC output. Nine AA-, C-, or D-cell batteries connected in series make a good supply, and is recommended if you have no other supply. Do not use a wall-type transformer, as those items are usually poorly regulated and could cause bad hum or damage to the circuitry. A stereo FM-broadcast receiver, a line-level audio source such as a CD player or tape deck, stereo patch cables for connecting the audio source to the transmitter round out the equipment list.

Before connecting power to the transmitter, inspect the PC board once again for shorts, missing or wrong parts, IC and transistor orientation, polarity of diodes and electrolytic capacitors, and any assembly mistakes such as missing or poor solder connections. If everything looks good, connect the VOM between the 13.2-volt power supply and D1, with the negative

power supply lead connected to ground. The meter should be set to measure DC current at 1 amp. If your supply has a meter that measures current, the VOM need not be connected. In that case, connect the positive supply lead directly to D1. When the power is turned on, the current drawn should be about 120 ma. If appreciably less than that (under 100 mA), or more (over 140 mA) is being drawn, shut down the supply and re-check the components and soldering, as something might be wrong. Nothing should be getting hot, although IC5 will normally run warm after a few minutes. If everything is OK, remove the VOM (if used) and directly connect D1 to the positive supply terminal.

With the meter set to read 15 volts DC, check the following points for proper voltages. The voltages listed are based on a 13.2-volt supply. If your supply provides a slightly different voltage, your readings may vary accordingly:

- IC5 input—12.6 volts
- IC8 pin 16—5.0 volts
- IC7 pin 3—5.0 volts
- Q5 collector—5.0 volts
- Q4 collector—1.6 volts
- Q1 drain—8.5 volts
- IC6 pin 7—8.5 volts
- IC1 pin 3—6.4 volts
- IC1 pin 7—6.4 volts
- IC1 pin 1—6.4 volts
- IC4 pin 16—8 to 10 volts

Variation of 10 percent or less in the above readings is acceptable. Remember to allow for meter accuracy and component and supply voltage variations. If any major variations are noted, go back and check your work again.

Set S1 for a frequency of 88.1 MHz or the closest clear channel if 88.1 MHz is used in your area. Listing 1 shows what switch settings will produce the desired frequency. If you want to produce even channels, install the jumper next to IC7 and set the transmitter for 88.0 MHz. Connect the meter across pins 1 and 4 (polarity does not matter) of IC2, and adjust R15 for a zero voltage reading. Use lowest scale you can.

Tune a nearby FM receiver to the selected channel. Monitor that

channel as you proceed. Set the plates of C16 to 25% mesh and R15, R24, and R35 to their center. Set the slug in L1 so it is fully inserted. Connect the meter to TP5 (pin 6 IC6). While listening on the FM receiver, start backing out the slug with a nonmetallic screwdriver. The meter will read initially about 8–9 volts. As you back out the slug further, a point should be reached where the meter reading starts to decrease. At that moment, the FM receiver should suddenly quiet down, and you will hear the carrier. As you adjust the slug, the carrier should still be heard in the receiver. Set the slug so that the voltage at TP5 is between 3 and 4 volts. The stereo-indicator light on the FM receiver should be lit. If it is not, adjust R35 towards maximum until it does light, and then a little further. The receiver should be quiet. Remove the 13.2 V supply. The stereo indicator on the receiver should drop out and the receiver background noise should reappear. If everything is OK so far, the next step will be to test the unit with an audio-signal input.

Connect a 12-inch antenna to the RF-output connection and apply a stereo-audio signal to inputs J1 (left) and J2 (right). Reconnect the DC supply and listen to the FM receiver. You should hear the audio in the receiver. Adjust R35 so that the received audio is at the same volume as other local stations in your area. Connect the audio-tone test point TP1 to each input individually using a test lead. The audio tone should sound in the receiver's left or right channels accordingly. Adjust R24 for best separation if necessary. If R24 seems to have little effect, leave it in the middle position.

The basic setup is complete. If you are fussy and have access to test equipment, you may perform the following additional steps:

Connect a frequency counter to the RF output and adjust C16 for exactly 88.1000 MHz, or whatever frequency that you have programmed.

Connect a counter or scope to TP1 and check for a 1187.5-Hz squarewave. That verifies that the pilot and subcarrier frequency are at 19 and 38 kHz.

With a scope connected to TP4,

adjust R15 for a minimum of 38-kHz subcarrier feedthrough. Temporarily kill the 19 kHz pilot by grounding the junction of R28, R29, and C12 in order to make that easy to see.

Using sinewave audio generator of 1.5 volts p-p and a frequency of 1000 Hz, check for waveform shown in Fig. 6 at TP4, with the left, right, and finally both inputs connected to the audio generator. Adjust R24 for best agreement to the figures. Some compromise may be necessary as the optimum setting for the

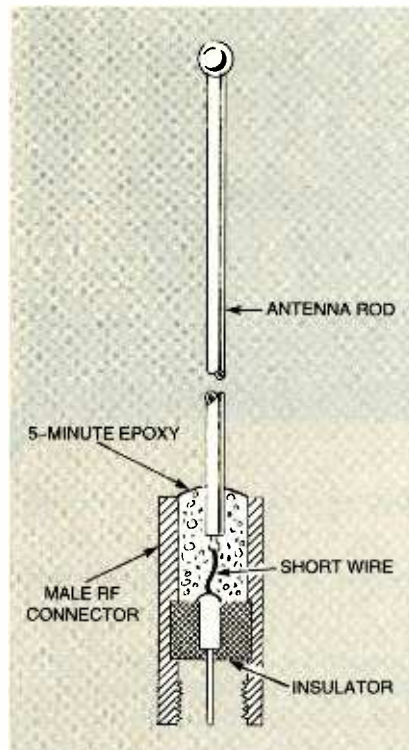

Fig. 7. A collapsible antenna soldered and epoxied to an RF connector makes an easily removed and replaced unit for the transmitter.

left and right channels might be slightly different due to normal circuit and component tolerances. Split any residual minor difference between the left and right channels so each has equal error.

Set the slug in L1 so that 3 volts is obtained at TP5 at the lowest desired operating frequency (usually 88.1 MHz). Set S1 for a frequency of 94.5 MHz, and verify that the voltage at TP5 is above 7 volts and still varies with slug setting. That tests the synthesizer frequency range. It is OK if the slug is almost out of the winding. Secure the slug with clear lacquer, cement, hot glue, or a drop of wax. Set the transmitter for

the desired output frequency you wish to use, and the transmitter is ready to go.

Final Packaging. The transmitter may be mounted in almost any case that will accept the PC board. Either metal or plastic can be used and since no significant heat is produced, ventilation is not critical, although it is a good idea to allow some airflow if possible. Make sure that any metal is at least 1/4-inch away from the bottom of the board. If a plastic case is used it is a good idea to line the bottom of it with copper or aluminum foil to act as a ground plane for the antenna. In addition, a ground bus of some sort will be needed with a plastic case. RCA-type phono jacks may be used for the audio connections, a 2.5-mm jack for the DC power supply, and a BNC connector for the RF output. Be sure to ground the shell of the RF output connector with a short lead to the ground foil on the PC board. Remember to keep the RF leads short. Audio connectors should be grounded to the audio ground, and audio leads shielded or kept short in order to avoid RF pickup and possible distortion. Metal or plastic standoffs can be used to mount the PC board to the case.

Antennas can be almost any suitable arrangement. One possible arrangement is to use a collapsible 12-inch antenna mounted into a right-angle BNC male connector with epoxy, which makes a neat, compact antenna. The construction details in Fig. 7 are self-explanatory.

The power supply could be a regulated 13.2-volt DC type commonly sold for powering CB radios and hobby projects. Any well-regulated supply should do fine if it has low ripple. Batteries can also be used, but will, of course, wear out eventually. However, for short periods where continuous use is not contemplated, they are excellent and do not introduce possible hum that can occur with AC-operated supplies. Wall-transformer types are definitely not recommended.

Using the Transmitter. For best results, a relatively clear channel is

PARTS LIST FOR THE STEREO FM TRANSMITTER

SEMICONDUCTORS

IC1—LM1458 dual op-amp, integrated circuit
 IC2—LM1496 balanced modulator, integrated circuit
 IC3—74C00 quad NAND gate, integrated circuit
 IC4—CD4040 12-bit counter, integrated circuit
 IC5—LM7805 5-volt voltage regulator, integrated circuit
 IC6—CA3420 op-amp, integrated circuit
 IC7—MC145151-2 phase-locked loop, integrated circuit
 IC8—74F160 decade counter, integrated circuit
 Q1—MPF102, field-effect transistor
 Q2-Q4—2N3563, NPN transistor
 Q5—MPS3866, NPN transistor
 D1—1N4007, silicon diode
 D2—1N757A, Zener diode
 D3—MV2107, varactor diode

RESISTORS

(All resistors are 1/4-watt, 5% units unless otherwise noted.)

R1, R2—8,200-ohm
 R3, R4, R11, R20, R30, R40, R46, R52, R55—1,000-ohm
 R5—R8, R32, R37, R38—22,000-ohm
 R9, R10, R26, R29—47,000-ohm
 R12, R13, R25, R41, R42—100,000-ohm
 R14, R16, R23, R43—68,000-ohm
 R15—10,000-ohm potentiometer
 R17, R18, R33, R50—2,200-ohm
 R19, R44—10,000-ohm
 R21, R22, R54—3,300-ohm
 R24—25,000-ohm potentiometer
 R27—220-ohm
 R28, R48, R51—470-ohm
 R31—2.2-megohm
 R34—220,000-ohm
 R35—1,000-ohm potentiometer
 R36—6,800-ohm
 R39—4,700-ohm
 R45—1-megohm
 R47—1,500-ohm
 R49—33-ohm
 R53—330-ohm
 R56—56-ohm

CAPACITORS

C1, C2, C20—0.01- μ F, 10%, Mylar
 C3—C5, C11—1- μ F, 50 WVDC, electrolytic
 C6, C9, C29—100- μ F, 16 WVDC, electrolytic
 C7, C8, C12, C13, C25, C26, C30, C32—0.01- μ F, ceramic disc
 C10—18 pF, ceramic disc, NPO-type
 C14—12-pF, ceramic disc, NPO-type
 C15—33-pF, ceramic disc, NPO-type
 C16—2–20 pF trimmer
 C17—39 pF, ceramic disc, NPO-type
 C18—10- μ F, 16 WVDC, electrolytic
 C19—0.1- μ F, 10%, Mylar
 C21—0.01- μ F, ceramic, surface-mount
 C22, C24—100-pF, ceramic disc, NPO-type
 C23, C27, C28, C36—470-pF, ceramic disc
 C31—470- μ F, 16 WVDC, electrolytic
 C33—68-pF, ceramic disc, NPO-type
 C34—120-pF, ceramic disc, NPO-type
 C35—47-pF, ceramic disc, NPO-type
 C37—10-pF, ceramic disc, NPO-type

ADDITIONAL PARTS AND MATERIALS

L1-L6—See text
 XTAL1—4.864-MHz crystal, 0.005%, HC49/U case
 XTAL2—10.240-MHz crystal, 0.005%, HC49/U case
 S1—SPST switch, 10 position, dual-inline package
 Slug for L1 (Cambion "Blue" 5153255-06-00, 30–400 MHz or similar), 22-gauge magnet wire, PC board, ferrite beads (Ferrox³ 267300101 or similar), hardware, enclosure, solder, etc.

Note: The following is available from: North Country Radio, PO Box 53, Wykagyl Station, New Rochelle, NY 10804; Website: <http://www.northcountryradio.com>: Complete kit consisting of an etched and drilled PC board and all parts that mount on it. \$75.00; Enclosure, \$15.50. Please add \$4.50 for shipping and handling.

necessary. The PLL helps tremendously by keeping the signal on frequency. In large metropolitan areas, it may be difficult or impossible to find a clear channel. In this case try using an in-between channel, *i.e.* even 100-kHz channels in the USA, odd 100-kHz channels in areas using even channel allocations. Also, you might try to get between two weak stations. That

can be impossible for digitally-tuned receivers, but analog (continuously tuned) receivers will have no problem. Many lower-end pocket stereos are still analog. It is best to operate between 88 and 92 MHz as that part of the band tends to be used by lower-powered stations.

Do not set deviation control R35 too high, as distortion and interference to other stations may result.

Typically R35 is set about 75% of full open when a typical line-level input (0.5- to 1-volt rms) signal is fed into J1 and J2. Exceeding that will result in distortion and loss of separation. In order to avoid hum, make sure the transmitter is properly RF grounded, especially if a whip antenna is to be used.

Where regulations permit (not in the USA), the voltage on the output amplifier can be raised as high as 15 volts, with up to 150-milliwatts output possible, though not guaranteed. In that case, a matched antenna should be used and L4 should be adjusted by compressing or expanding the turns for maximum output. A range of up to a mile or more might be possible, depending on local terrain if a properly matched antenna is used. Keep the antenna at least 25–30 feet from the transmitter when operating above the 10-milliwatt RF output level, as it is possible that stray RF feedback from the antenna might cause instability and loss of lock in the PLL circuit. The transmitter is strictly an entertainment device and is not meant for commercial broadcasting; therefore no guarantees of any kind can be offered nor any technical assistance be provided for export use. Those details must be worked out by the individual user.

There you have it—a stereo FM transmitter that is as fun and easy to use as it is educational. Ω

"YOUR FREE CATALOG KNOCKED MY SOCKS OFF"

We get that sort of comment all the time. People are impressed that our free Consumer Information Catalog lists so many free and low-cost government booklets. There are more than 200 in all, containing a wealth of valuable information.

Our free Catalog will very likely impress you, too. But first you have to get it. Just send your name and address to:

**Consumer Information Center
 Department KO
 Pueblo,
 Colorado
 81009**



BUILD YOUR OWN BEAM ROBOT

*Learn about the new
“bottom-up” method of robot
design by building a simple
stimulus-response unit.*

JOHN IOVINE

Photo courtesy Mark Tilden

Robots have traditionally been designed with some form of computer control within their chassis. In order for the robot to do a particular task, a program that controls the robot's movement has to be loaded into the robot's on-board computer before commanding the robot to execute the instructions. That method works well for repetitive tasks in an environment that is well controlled, such as an assembly line in a factory.

However, when an “intelligent” robot is put into an environment that cannot be controlled, such as a home or outdoors, the complexity of the machine must rise dramatically. The program must be able to cope with all possible unforeseen circumstances that might occur, like the ability to not accidentally kill any human who might come in contact with the machine—or at least get within striking distance.

Another possible programming method is to create a rules-based or “expert-system” program that can make decisions and learn from its environment. That type of program is even more complex since it must be able to reason out any situ-

ation it has not experienced before.

A new approach to robot design has been developing over the last several years. That method is called BEAM robotics.

What is BEAM Robotics? BEAM is an acronym that loosely stands for Biology, Electronics, Aesthetics, and Mechanics. Other groups of words can also be substituted in the acronym. One alternate definition is Biotechnology, Evolution, Analog, and Modularity.

The BEAM robotics school of design was founded by Mark Tilden at the University of Waterloo, Ontario, Canada. He was inspired by a lecture given by Dr. Rodney Brooks of the Massachusetts Institute of Technology in 1989. In that lecture, Dr. Brooks discussed a new approach to robot design with which he had been experimenting.

The new approach involved removing any computer-based programming and substituting a simple hard-wired circuit that would respond to some type of outside stimulus. Different stimulus-response circuits can be layered on top of one another. That type of multi-layer-

ered stimulus-response design, sometimes called *subsumption architecture*, can exhibit what appears to be intelligent behavior.

Designing a BEAM Robot. Let's build a few stimulus-response layers and see if we can create what might appear as intelligent behavior. Our BEAM robot will be a “photovore” device—that is, something that eats light, like a herbivore (plant-eater) or carnivore (meat-eater).

The first layer will respond to two photoresistors mounted on each side of the robot. That circuit will be able to determine if a light source is stronger on the left or right. The photoresistor inputs will control a steering mechanism. When the light intensity on both photoresistors is equal, the robot will be steered straight ahead. If either input is brighter than the other, the robot will turn in that direction. That behavior will let the robot lock onto a light source and track it.

The second layer will be a simple light-threshold detector. When the light intensity is great enough, the threshold detector will cut power to

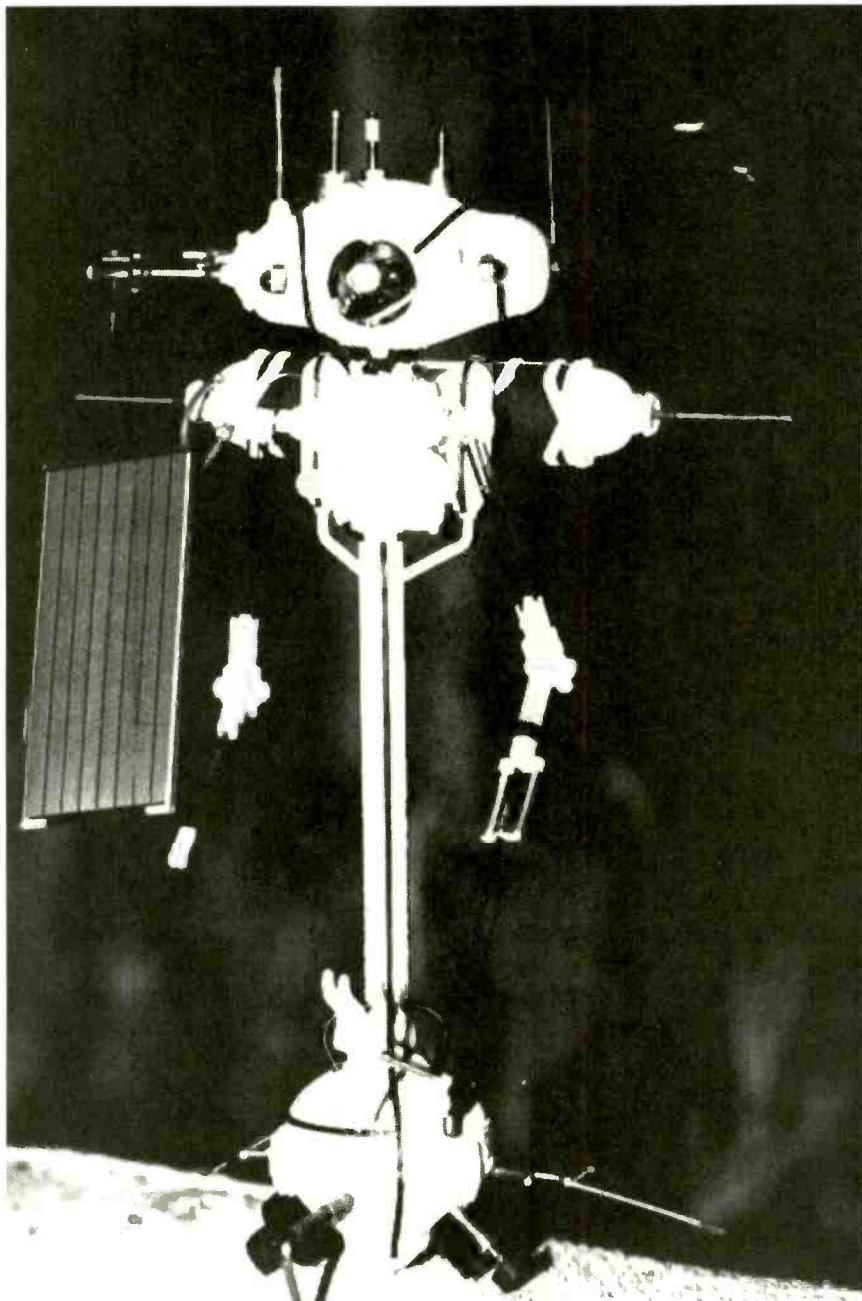

Fig. 1. BEAM robots are excellent test beds for experimenting with new concepts. This particular example studies the coordination between head movement and wheeled movement. (Photo courtesy Mark Tilden.)

the robot's drive system. The robot can then feed on the light, charging its main power supply through a set of photovoltaic cells.

The third layer is another light-threshold detector. However, that detector will cut power to the drive system when it gets too dark. If there is not enough light to charge the batteries or search for a light source, the robot will go to sleep in order to conserve power.

Now we can study the behavior

of that three-layer stimulus-response system to see if it can be classified as intelligent. In complete darkness, the robot does not move because of the third layer—very much like our need for sleep. That conserves all of its power. Increasing the ambient light lets layer three energize the drive system again, waking up the robot. Layer one then takes over and controls the direction of the robot. The robot searches for and moves toward the source of light. As

the robot moves toward the light source, the light intensity increases. When the light is bright enough, layer two cuts power to the drive system. The robot then "feeds" (charge its batteries) through the photovoltaic cells.

Whether or not that type of robotic behavior can be classified as intelligent is an individual preference and can be debated from both points of view. However, it does show how complex behavior patterns can be generated using simple layers of stimulus response.

Back On the BEAM. A central idea to the BEAM philosophy is robotic evolution—start simple and evolve toward complex systems. In order to follow that philosophy, the robot designer is encouraged to break away from standard robotic design. Instead of using a top-heavy central-processors system for control, use a bottom-up approach with layered-stimulus response. Those layers are also known as neural networks or nervous-network systems.

Mark Tilden calls his stimulus-response mechanisms "nervous nets". He has designed a number of interesting robots using what he calls a nervous-net system that is made using transistors. He has received a patent for his circuits, and has authored a book entitled "Living Machines", which is planned for publication sometime in 1997. In that book, schematics for Mr. Tilden's nervous nets will be published.

To get an idea of the type of BEAM robots Mr. Tilden builds, let's look at a few of his designs. Figure 1 is called the *Neuspotter 1.4*. It is an 8-transistor solar-powered device designed to study the nature of

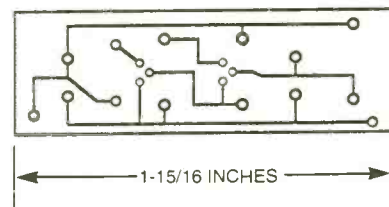

If you want to etch your own PC board, this foil pattern will make the circuit quite compact. The circuit is simple enough to be laid out on a single-sided board.

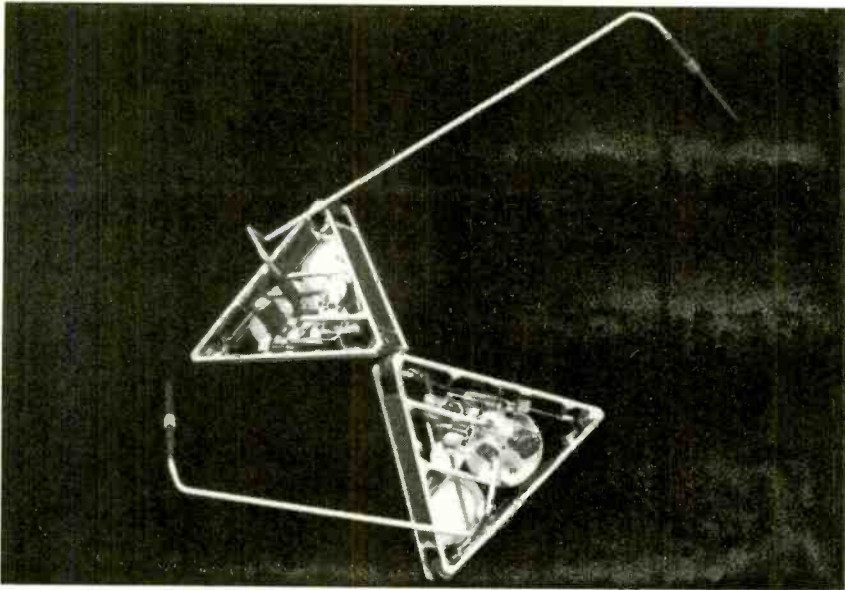

Fig. 2. These Tilebots demonstrate how similar-shaped robots can assemble themselves together to make a larger device. (Photo courtesy Mark Tilden.)

head-motion with respect to wheeled action. It is about 8-inches high and was designed as a prospective prototype for NASA.

The result of asking, "What would a triangle do if it could?" is the *Tilebot* in Fig. 2. Those *Tilebots* are single-neuron units that demonstrate that similar-shaped devices can self-assemble themselves into larger living machines. Each device is solar powered and measures 3 inches across.

The *Gumby Trks* of Fig. 3 is a type of biomechanical walkers that are designed for many different types of terrain. Here, *Gumby 1.0*, an 8-transistor walker about a foot long, makes tracks across sand.

Figure 4 is titled *Walkman 1.0*. This device was put together from the remains of five similar portable-cassette players. It has seven sensors, including two eyes, and can handle very complex terrains with its 5-motor design.

BEAM robotists pride themselves on using discarded electronics in the construction of their robots. For instance, solar cells from calculators, high-efficiency electric motors from portable-cassette players, along with pulleys, switches, capacitors, components, gears and solenoids are all sources of components and inspiration to the BEAM designer. Gathering together

electronic flotsam and converting it into useful robots is an excellent example of recycling engineering.

The BEAM Olympics. The first Olympic-style competition for BEAM robots was held in 1991. The inspiration for the BEAM games came from the first International Robot Olympics held in Glasgow, Scotland in 1990. The competition is now held annually with 14 different events. The BEAM robotic competition is open to everyone, with all competitors on equal footing. A seven-year-

old robotist has as much chance of winning as a professor from a prestigious college does. In some cases, the seven-year-old won!

If you want more information, a 120-page guidebook is available from: BEAM Games, c/o Karen Olivas, Los Alamos National Laboratory, PO Box 1663, MS D466, Los Alamos, NM 87545. The guidebook costs \$20.00, and a check or money order should be made out to "BEAM: University of California." The successes of the BEAM competitions are spawning new games like the West Canadian Games. This and other useful links can be found on the BEAM homepage (<http://sst.lanl.gov/robot/>).

Building a BEAM Robot. With a basic understanding of the concept of BEAM robotics, we can design and build a simple stimulus-response device. Once the robot is up and running, it can be used as a basis for further refinement and experimentation.

The best place to start is with the power plant. The circuit in Fig. 5 is an improved variation of a circuit originally designed by Dave Hrynkiw of Canada. The main components are a solar cell, a main capacitor, and a trigger circuit. The solar cell, PC1, charges C2. As C2 charges, the voltage level of the circuit increases. As

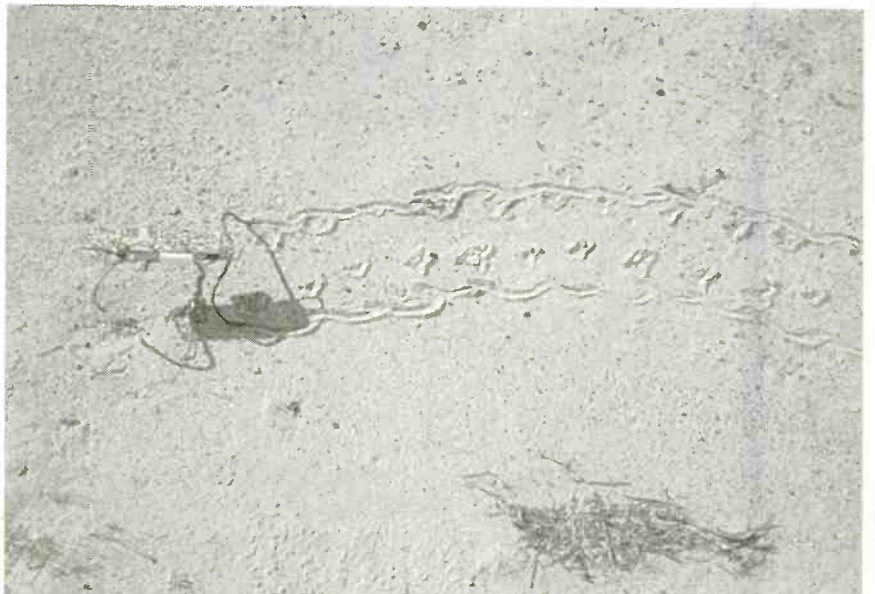

Fig. 3. Legged robots are quite versatile when it comes to moving over different surfaces. (Photo courtesy Mark Tilden.)

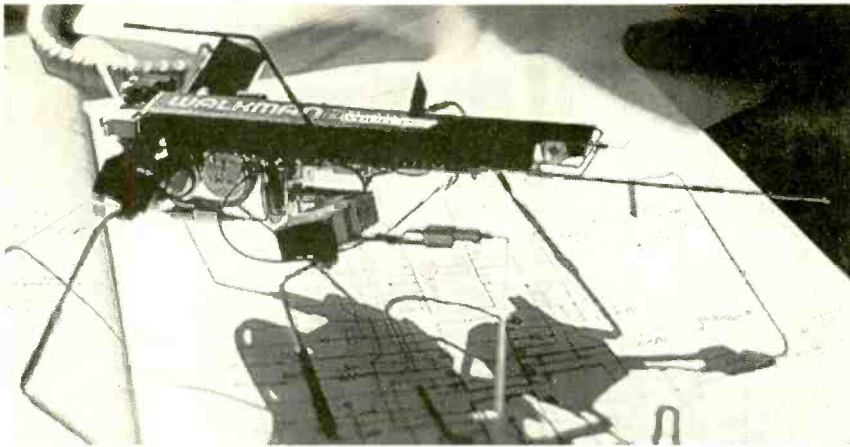

Fig. 4. Robot builders tend to be very resourceful when finding parts for their creations. The Walkman legged robot shown here was built with many parts from several portable-cassette players. (Photo courtesy Mark Tilden.)

the voltage increases, the oscillator circuit built around Q1 begins oscillating. Trigger pulses are sent to SCR1. Those pulses, however, are not strong enough to trigger SCR1 until the voltage has risen to about 2 volts at the main capacitor. When

SCR1 turns on, all the stored energy in C2 is dumped through MOT1, a high-efficiency motor. The motor spins for a short while as the capacitor discharges. The cycle then repeats.

The circuit is simple and non-critical. It can be constructed using point-to-point wiring on a perf-board. For those who want to make a neat-looking project, a PC board pattern has been provided. If you

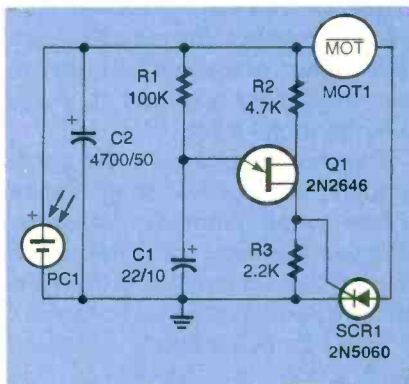

Fig. 5. This simple power supply uses sunlight to charge a capacitor. When the capacitor reaches a critical voltage, the SCR fires, spinning the motor.

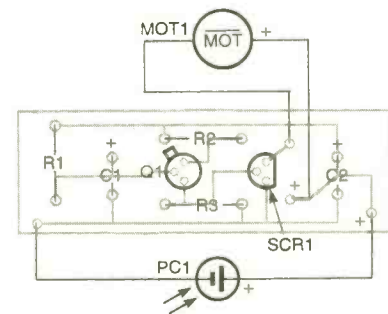

Fig. 6. If you use the foil pattern to etch your own PC board, use this diagram to place the components. Be careful of the polarity of the capacitors and semiconductors.

use the PC board pattern to etch a board, the parts-placement diagram in Fig. 6 shows the locations of the various parts.

Special Parts. Not all electrical motors are high-efficiency types. For instance, the small electrical motors sold at your local RadioShack store are of the low-efficiency type. There is a simple way to determine if a motor is a high-efficiency type. Spin the rotor of the motor. If it spins smoothly and continues to spin freely after it is released, it is probably a high-efficiency type. If, on the other hand, the rotor feels "clunky" or there is resistance to spinning it, it is probably a low-efficiency type. High-efficiency motors might be found in portable battery-operated cassette players.

Also note that the solar cell used in this project is a high-voltage, high-efficiency type. Most typical solar cells supply about 0.5 volts at various currents depending upon the size of the cell and the intensity of the light. The solar cell used in the BEAM robot is rated at 1.5 volts, but some cells might be able to charge a capaci-

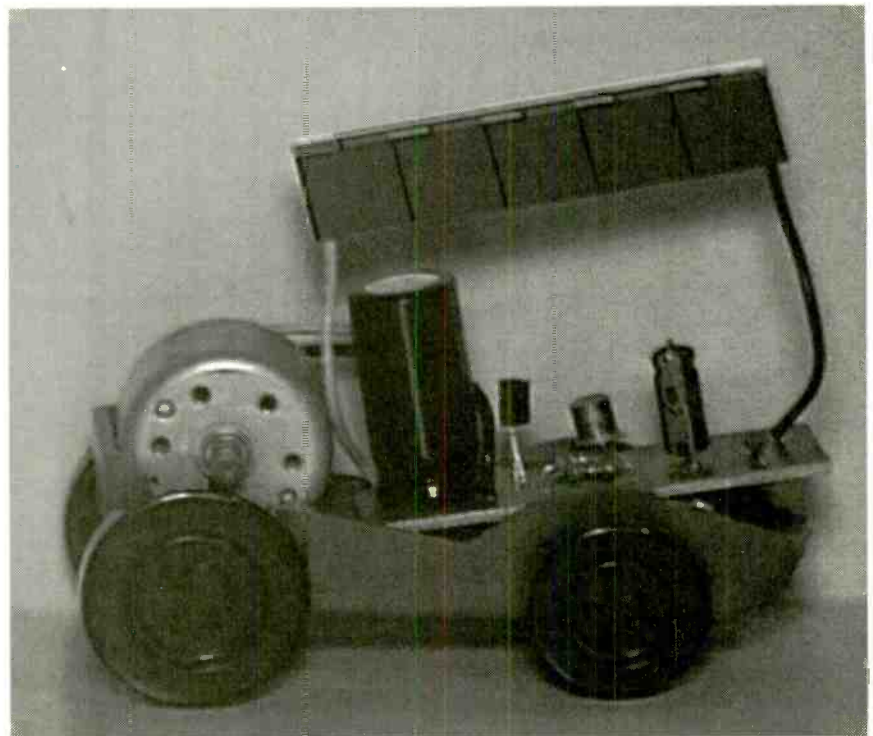

Fig. 7. The completed Solar-Roller robot is mounted in a toy car chassis. A rubber tube on the motor shaft along with the weight of the motor creates a simple and self-adjusting friction drive.

The BEAM Olympics

Below are some brief descriptions of the different competitions held at the BEAM Olympics:

Solaroller: A solar-powered robot racer, which can be no larger than a 6-inch cube, runs along a 6-inch wide, 1-meter long track made of glass (Class A) or rough terrain (Class B). Maximum solar cell size is 1/2-inch × 2-1/2-inches (1-1/4 square inches). Competitors race in full sunlight or a 500-watt halogen lamp.

Photovore: A solar-powered goal-seeking robot, whose overall size can fit within a 7-inch cube, is placed with other competitors in a closed "Jurassic Park" environment for 30 hours. Those robots that show the best survival, exploration, confrontation, speed, and power efficiency as determined by a review of photos and video, will be the winners.

Aquavore: A solar-powered robot, whose overall size can fit inside a 7-inch cube, swims the length of a 55-gallon fish tank (a distance of about one meter). A 6-inch high wall is placed in the middle of the tank. The robot must pass over the wall to reach the finish line.

Robot Limbo: A robot, whose overall size can fit inside a 7-inch cube, must run through a simple maze. Solar power is not required for that event, but is recommended.

Robot Rope Climbing: A robot is to climb up and back down a 1-meter length of 40-lb. test nylon fishing line. The overall size of the robot must fit within a 20-inch cube.

Robot High Jump: A robot must be able to jump its entire mass into the air three times using the power from one optional battery. The robot must fit within a 1 square foot space.

Robot Long Jump: A robot must be able to jump its entire mass forward three times using the power from one optional battery. The robot must fit within a 1 square foot space.

Legged Robots: Legged robots are judged on their ability to walk over various terrains and negotiate obstacles. There is no size restriction.

Innovation Machines: The purpose of a new robot creation need not be obvious. Competitors are judged on quality of workmanship, broadness of scope, and strangeness of application.

Robot Art/Best Modified Appliance: Create a robot that can draw or generate art. The generation of art may be the movement of the robot itself. An example of that is a solar flower that opens slowly when light shines upon it and snaps closed when the light is removed. Robots built completely from scratch are placed in the Class A category, with Class B robots being modified devices such as toys or appliances.

Robot Sumo Wrestling: Robots are paired together in competition. They can be self-contained, tether-controlled, or R/C-controlled. For the Class A category, the robots attempt to push each other off the edge of a 5-foot round platform. For the Class B category, the platform measures 6 feet in diameter.

Nanomouse: A self-contained robotic mouse with a footprint no larger than 10 centimeters square must run through a maze. There is no restriction on the height of the device.

Micromouse: The rules are the same as for the Nanomouse competition, only the footprint can be no larger than 25 centimeters square.

Aerobot: A flying robot launches itself and flies into a 25-foot by 25-foot zone, finds a randomly-placed target in the zone, drops a marker on the target, and then returns to its launch pad.

Miscellaneous: This is a catchall for any robot that does not fit into any of the categories listed above.

tor up to 2.5 volts with no load.

Construction. One possible chassis for a BEAM robot that could compete in the "solar roller" category at the BEAM Olympics is shown in Fig. 7. It is based on a toy car. If you wish, you might build your own chassis.

The top was cut off the toy car with a pair of small cutting pliers.

The PC board was glued onto the

chassis with the solar cell held above the car by the stiffness of the wires that connect it to the PC board.

Creating a drive system for the robot in that example turned out to have a simple solution. A short length of small-diameter rubber tubing was slipped over the metal shaft of the high-efficiency motor. That provided a good friction surface for the motor shaft. Alternative coverings might

PARTS LIST FOR THE BEAM ROBOT

- Q1—2N2646, unijunction transistor
- SCR1—2N5060, silicon-controlled rectifier
- C1—22-F, 10WVDC, electrolytic capacitor
- C2—4,7000-F, 10WVDC, electrolytic capacitor
- MOT1—DC motor, high-efficiency type (see text)
- PC1—1.5-volt photovoltaic cell (see text)
- R1—100,000-ohm, 1/4-watt, 5% carbon resistor
- R2—4,700-ohm, 1/4-watt, 5% carbon resistor
- R3—2,200-ohm, 1/4-watt, 5% carbon resistor

Note: A complete kit of parts (less chassis) is available from Images Company, PO Box 140742, Staten Island, NY 10314, Tel: (718) 698-8305, for \$25.50 including shipping and handling. NY residents must add appropriate sales tax.

include the insulation from some large-diameter wire or rubber handle covers from some miniature toggle switches. Whichever method you use, the covering should fit snugly over the motor shaft.

The motor is placed in the chassis so that the covered shaft rests on a back wheel. When the circuit discharges, the shaft spins the wheel, moving the car forward. That simple friction drive is not very efficient, but it has the advantages of being both simple and functional. Feel free to create your own more efficient drive mechanism.

Modifications. One obvious addition to the mechanism is to add a few more solar cells to speed up the charging rate of the circuit. While low-voltage solar cells can be added in series to reach a greater voltage, it is not recommended to add solar cells in parallel to increase the total current. The main reason is the design of the charging circuit. In order for the circuit to recycle, the current through the SCR must either stop or drop below the device's minimum holding current in order to let the SCR turn off. If too much current is supplied by a

continued on page 57

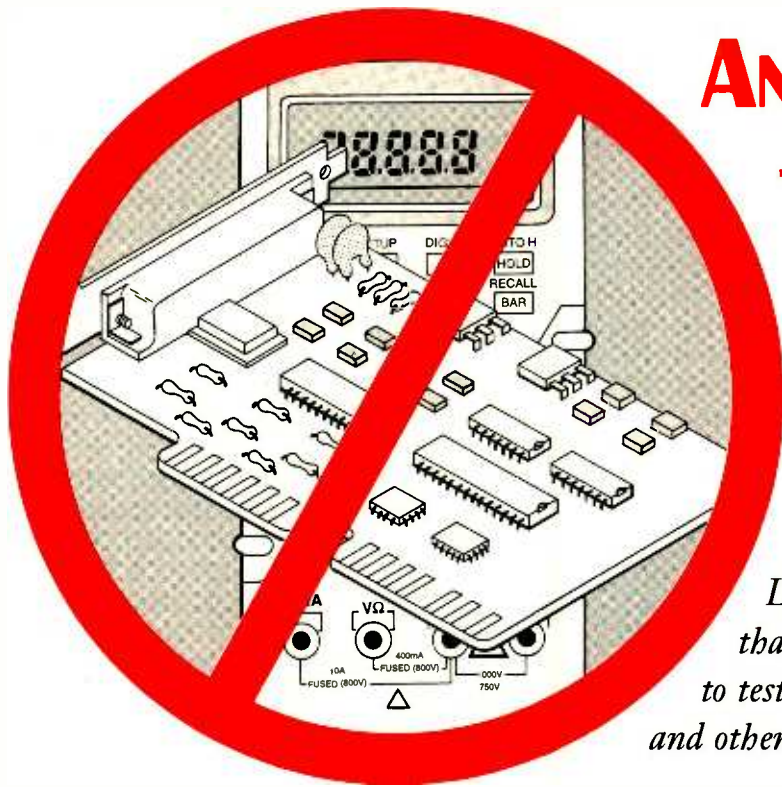

AN INTRODUCTION TO BOUNDARY SCAN TESTING

*Learn about a new standard
that makes it easier than ever
to test microprocessors, DSPs,
and other complex digital integrated circuits.*

J. DANIEL CONNELL

In 1990, the Institute of Electrical and Electronics Engineers (IEEE) unveiled a new testing standard that is revolutionizing the way test technicians deal with digital circuitry. Called IEEE 1149.1 Test Access Port and Boundary Scan Architecture, or simply "Boundary Scan," it is a non-contact test method that allows the application and capture of electronic circuit test data via a specialized serial test chain. Boundary Scan is fast becoming visible in every new digital system.

Needless to say, a basic understanding of the standard is a must for any person who is attempting to repair, design, or otherwise work with new digital circuits. New versions of the familiar "74" series of digital-logic ICs adhere to that standard. Other well-known devices, such as the Intel 486 and Pentium microprocessors, as well as various Digital Signal Processors (DSPs) and Field Programmable Gate Arrays (FPGAs), now include Boundary Scan circuitry as an integral part of the IC.

The Impact of Boundary Scan. Technology progresses in a fast and non-linear fashion. It has only taken

a small number of years to go from the large-sized vacuum-tube computer to the very powerful, and very small, digital logic of personal computers. During that span of time, an incredible evolution in design and testing took place: Construction methods of electronic systems went from the very large point-to-point wire harness to the super compact Multi-Chip-Module (MCM). That evolution, occurring over such a short period of time, has resulted in many new challenges for those who need to design, test, or repair digital circuits. New designs of complex digital logic can now be literally untestable. That is because of the compact size of the components and because of limited real estate for test points. With the advent of Boundary Scan, it becomes easier to design, manufacture, test, and repair modern electronic products.

Conventional test/repair methods require the test person or ATE (automatic test equipment) to have direct physical contact to each and every electrical connection on every logic device. For instance, if you needed to test or troubleshoot a serial card contained within a

computer, you would need to disassemble the computer, remove the serial card, place the card in some sort of functional tester, apply logic patterns to the inputs of the logic ICs (using a logic pulser or other device), and then observe the logic outputs (using a scope or logic probe). Traditional testing generally requires that the probes be moved to each point on the IC. If the card has 1000 pins on 75 total ICs, the probes will need to be moved to a substantial number of pins for testing purposes.

That method is time-consuming and requires that the operator have access to all electrical points on the circuit card. Moreover, testing of complex devices such as FPGAs, DSPs, and microprocessors, becomes near impossible without dedicated test equipment costing hundreds-of-thousands-of-dollars. Physical access to surface-mount components becomes difficult without specialized probes and test techniques. In addition to all of that, the skill level of the person attempting to repair and diagnose faults in the circuit must, at a minimum, be that of a senior-level elec-

tronics technician. In some cases the education level must be equivalent to that of a digital design engineer.

If that same serial card had been designed using 100% Boundary-Scan-type ICs, it would be a simple matter to initialize a small diagnostic program via the Boundary Scan Port. That program would return information that details any logic faults on the board. Boundary Scan testing identifies more than just a

Shortly after Beenker's paper was published, an *ad hoc* group of European electronics companies recognized the need for a better, more-efficient standard concerning the test and repair of digital logic. As a result of that meeting, the Joint European Test Action Group (JETAG) was formed. Soon, companies from North America began to participate and the name was appropriately shortened to JTAG (Joint Test Action Group).

special serial chain path. That serial chain is placed between each external logic pin and the core logic of the IC; hence the term Boundary Scan. Many conventional devices now include Boundary Scan as an integral part of the IC.

The basic Boundary Scan concept is illustrated in Fig. 1. The square boxes between the external I/O pins and the IC core logic are referred to as Boundary Scan Cells (BSCs). The BSCs are interconnected to form a scan path between the IC's Test Data Input (TDI) pin and Test Data Output (TDO) pin. During normal IC operation, input and output signals pass freely through each BSC from the Normal Logic Inputs to the Normal Logic Outputs. However, when the boundary-test mode is entered, the IC's Boundary Scan chain is controlled in such a way that test data can be shifted in via the TDI and applied to the core logic (from each of the three BSCs located at the input pins). Parallel control of each BSC is accomplished by use of the Test Clock (TCK) and the Test Mode Select (TMS). The core logic response is then captured via the BSCs located at the core logic output. After the test data has been captured, it is shifted out for inspection. That method is useful for testing the internal logic of an IC.

External testing of circuit-trace interconnects, bad solder joints, or neighboring ICs on a board assembly is accomplished by applying test stimulus from the output BSCs of one IC and capturing the test response at the input BSCs of the neighboring IC. That technique overcomes many test problems associated with physical accessibility.

The Boundary Scan Cell. The Boundary-Scan cell is the basic block upon which the scan concept is built. The logic diagram of a single BSC is shown in Fig. 2. As shown there, the BSC is composed of a D-type latch and a pair of data-steering buffers. The data-steering buffers are controlled by the test access port (TAP) shown in Fig. 1. The TAP functions will be explained a little later in this article.

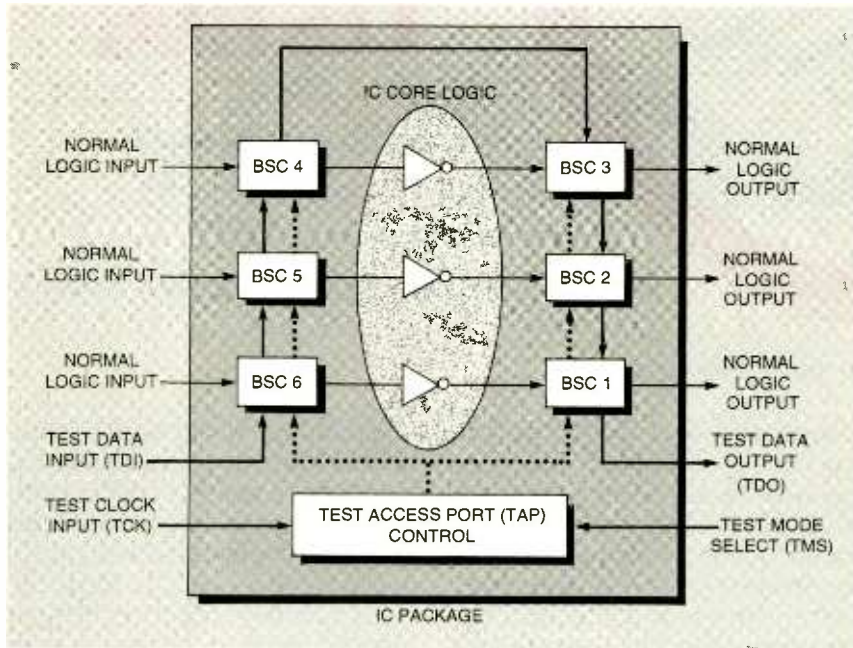

Fig. 1. The basic Boundary Scan concept is shown here. The square boxes between the external I/O pins and the IC core logic are referred to as Boundary Scan Cells (BSCs).

faulty IC; it troubleshoots to the problem pin of the defective component. All that is typically done is under two seconds, and it is done without oscilloscopes or meters, and without disassembly. It is not hard to see the advantages to Boundary Scan.

Scan History. Frans Beenker, of Phillips Research Labs, Netherlands, recognized the limitations of conventional testing techniques in digital designs. In 1985 he authored a paper detailing the need for a better, faster, and more structured approach to board-level testing. He strongly implied that a Boundary-Scan system would be the choice solution to many current and future test problems.

An initial JTAG standard was proposed in 1986 by Beenker, Chantal Viver (Bull Systems, France), and Colin Maunder (British Telcom Research Labs, UK). After that, several other scan proposals were submitted. Version 2.0 of the proposed scan was submitted to IEEE in 1988 for inclusion as an international standard. On February 15, 1990, the IEEE approved the standard as 1149.1, The Test Access Port and Boundary Scan Architecture.

What is Boundary Scan?

Boundary Scan is a method of testing that does not require physical access to each pin of an IC during test or hardware debug. Inside a Boundary Scanable IC is a unique set of logic gates that make up a

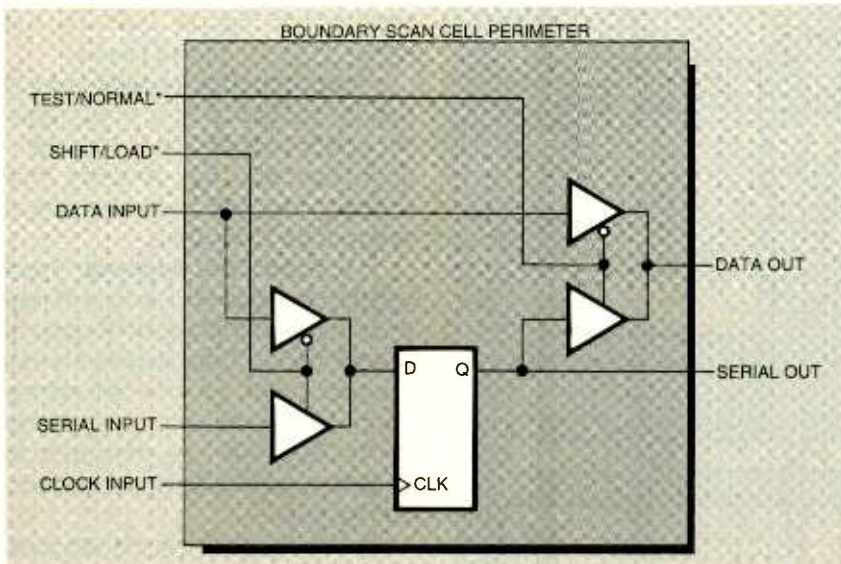

Fig. 2. As shown in this logic diagram, a BSC is composed of a D-type latch and a pair of data-steering buffers.

It is important to note here that construction of typical Boundary-Scan Cells are generally more complex than what is shown in Fig. 2. That is because many IC pins are bi-directional, tri-state, etc. The purpose of the illustration is to help the reader understand the concept and use of the Boundary-Scan Cell.

Normal Mode of the BSC. For the purpose of this discussion, let's assume that Fig. 2 is the inside look at BSC 6 of the IC shown in Fig. 1. During normal IC operation, input data from the external IC pin enters at the DATA INPUT line of the BSC. The control line, TEST/NORMAL*, is a logic low, while control line SHIFT/LOAD* is held at a logic 1. That condition allows the signals present at the IC pin input to travel from DATA INPUT to DATA OUT unimpeded. In that mode, the IC functions as if the Boundary Scan-cells did not exist.

At the same time that the IC is performing its normal logic functions, test data can be shifted into (and out of) the BSC. The CLOCK INPUT line is used to shift the data present on the SERIAL INPUT line into the D-type latch. In our example here, the SERIAL INPUT line is the Test Data Input (TDI) line shown in Fig. 1. Because all of the control lines of each BSC are connected in parallel, subsequent clock pulses will shift the data out of this BSC and into the next high-

er numbered BSC in the boundary-Scan chain. There is also a sequence for capturing the data present on all scan cell inputs. When a Boundary-Scan device has captured and/or shifted test data in/out in that manner, the IC is said to be in the Sample/Preload mode.

Test Mode of the BSC. In discussing the test mode of the BSC, it is imperative that the reader realize that all control signals are in parallel. In other words, when you clock a pulse to one Boundary-Scan cell, you clock them all and all cells are in the test mode or all of them are in the normal mode. With that in mind, here is one possible core-logic test operation:

Serial data is shifted into Boundary-Scan cells 6, 5, and 4 from the SERIAL INPUT while the IC is in the normal operational mode. The control line, TEST/NORMAL*, is then made to be a logic 1. That causes the latched data at the Q outputs of cells 6, 5, and 4 to be applied to the internal core logic via the DATA OUT lines. Next, the control line, SHIFT/LOAD*, would be changed to a logic low. That action causes the outputs of the core logic to be applied at the D inputs of the latches located in Boundary-Scan cells 1, 2, and 3. The clock is pulsed to capture the output data of the core logic into the D-type latch. Next the SHIFT/LOAD* control line is returned

to a logic 1 and TEST/NORMAL* is changed back to a logic zero. Finally the clock is pulsed three times to shift out the captured core logic data. To better illustrate a logic test, consider the following test sequence.

The IC in Fig. 1 represents three recitations of an inverter. The inputs are on the left; the outputs are on the right. If the serial input pattern of Fig. 3, 101xx (LSB of the test pattern shifted in first, x = don't-care state) is shifted into the TDI, the upper and lower inverters will have a logical 1 applied to their inputs, while the middle inverter will have a logic 0 applied. After the issuance of a chip-logic test sequence by the TAP, BSCs 1, 2, and 3 will contain the complement of the previously loaded BSCs 4, 5, and 6. If the core logic has performed the correct logic function, commanding the TAP to shift out 6 bits of data will result in the output pattern of xxx010 (LSB of the test pattern shifted out first, x = don't-care state). Any other data pattern means that the internal logic has a problem. IEEE 1149.1 calls this type of test function the INTEST.

Another desirable test mode that can be accomplished by Boundary Scan ICs is EXTEST. EXTEST is used to test external connections between boundary Scanable ICs (this is also known as an interconnect test). That test is performed by loading the

BSC #	6	5	4	3	2	1
INPUT	1	0	1	x	x	x
EXPECTED	x	x	x	0	1	0

NOTE: LSB (BSC #1) IS ALWAYS SHIFTED IN/SHIFTED OUT FIRST

Fig. 3. Here is a sample input and the output that is expected if the core logic of the IC is working correctly.

serial scan chain with a pattern in order to verify that no shorts, opens, or stuck-at-logic faults exist on interconnecting paths between scan ICs.

Figure 4 shows two inter-connected Boundary-Scan ICs. Notice that between two of the circuit connections there is a solder bridge. Also, one of the connections is shorted

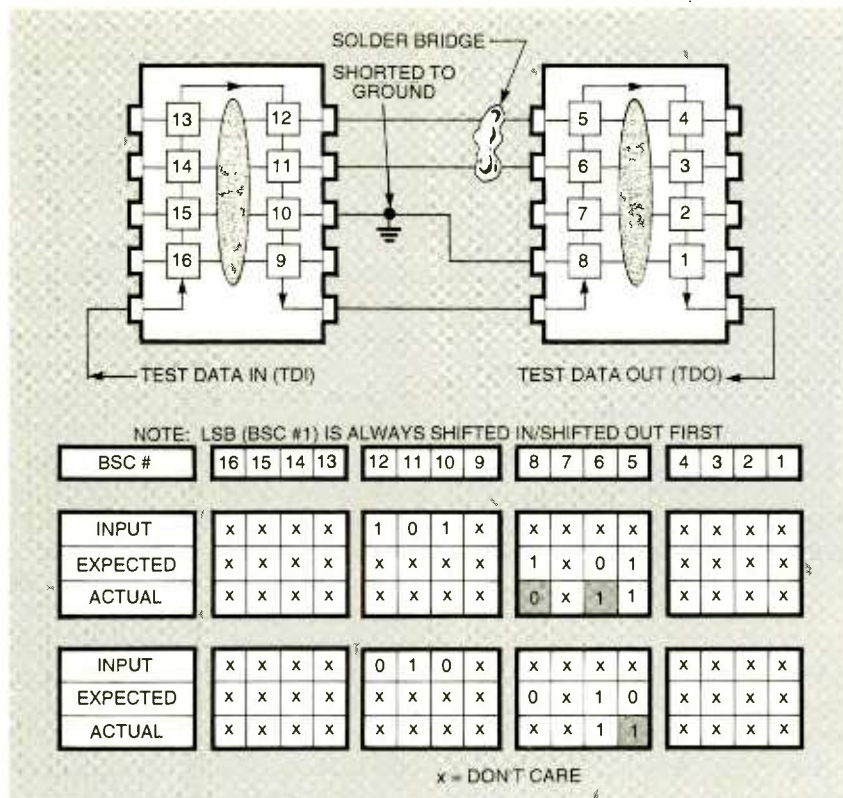

Fig. 4. With the input shown, here are the expected and actual outputs obtained when two interconnect chips have the common faults illustrated.

to ground. Those are common defects found in normal manufacturing and repair processes. Here is how Boundary Scan can detect those faults using the SAMPLE/PRELOAD and EXTEST instructions.

To perform an interconnect test, a serial pattern is loaded into the serial scan path using the SAMPLE/PRELOAD instruction. The particular pattern used in this case is xxxx 101x xxxx xxxx, where "x" indicates the "don't care" logic state. At the start of the EXTEST instruction, a logic 1 is applied to the output of BSC 12 and BSC 10, and a logic 0 is applied to the output of BSC 11. The EXTEST instruction then captures the data transferred to the inputs of Boundary-Scan cells 5, 6, and 8. The resulting BSC data is then shifted out and analyzed.

The test data output is expected to be xxxx xxxx 1x01 xxxx. Instead, it is found to be xxxx xxxx 0x11 xxxx. The logic 1 captured in BSC 6 is incorrect because the input of that cell is shorted to the input of its neighbor, BSC 5. The logic 0 that shows up at BSC 8 is due to the short to ground.

A second pattern is now shifted into the serial scan path. This time the pattern is changed to xxxx 010x xxxx xxxx. The EXTEST is performed and the data shifted out returns as xxxx xxxx 0x11 xxxx. After a brief analysis of the data it can be reasonably concluded that the interconnect between scan cells 10 and 8 is stuck at ground and the interconnects between scan cells 5, 6, 11, and 12 are shorted together.

The Top Level View and the TAP Controller.

Now that we have covered the basic concept of Boundary Scan, it is time to get a "top-level" look at the circuitry involved in an actual Boundary-Scan IC. Figure 5 shows the IEEE 1149.1 Top Level Architecture for the entire test logic of Boundary Scan. The top level schematic is comprised of three functional blocks:

- **The TAP Controller:** That device is actually a 16 stage finite-state machine. It is a small microcontroller that responds to control inputs supplied to it by the Test Access Port and it generates the essential clock

and control signals used by the other circuit functional blocks.

- **The Instruction Register:** This is a First-In-First-Out (FIFO) serial register that is loaded with a Boundary-Scan op-code. The op-code indicates to the TAP controller which test is to be performed.

- **The Test Data Registers:** These registers are also FIFO serial shift registers. The Boundary-Scan Register is one of the Test Data Registers and is comprised of all the Boundary-Scan cells in the scan path. Other Data Registers are the Bypass Register and the Device Identification Register.

The three circuit blocks are connected to four, or optionally, five input/output signals that control the operation of the Boundary-Scan circuits. Those signals are: test clock input, test mode select, test data input, test data output, and the optional test reset. Each is described below:

- **The Test Clock Input (tck):** This clock drives the TAP Controller and is completely independent of any other system clocks that may be connected to the core logic of an IEEE 1149.1 compliant device. The rising edge and falling edge of this clock are important to the Controller. The rising edge begins a load of the tms and tdi input pins; the falling edge clocks out signals to the tdo. In other words, data is clocked into the Boundary-Scan part on the rising edge and data is clocked out on the falling edge.

- **The Test Mode Select Input (tms):** A sequence of 1's and 0's is clocked into the TAP Controller via this pin. The sequence of binary data indicates to the Controller which one of its 16 states is to be selected. That, in turn, causes the Controller to generate the correct clocks and control signals to all other parts of the Boundary-Scan circuit.

- **The Test Data Input (tdi):** This is a serial-data input line. The data is either an instruction or pre-load information for the Boundary-Scan device. Data is applied LSB to MSB, and the number of bits will vary with the number of Boundary-Scan cells or instruction op-codes. Data

is latched into a data register on the rising edge of tck .

- **The Test Data Output (tdo):** The TAP Controller sends out the results of a scan or instruction via this serial-data output line. Data is clocked out on the falling edge of tck , while data at tdi is being shifted in on the rising edge of tck . tdo data is shifted out LSB to MSB. When data is not being shifted through the TAP, tdo is placed into a high-impedance state.

- **The Optional Test Reset Input (trst):** The IEEE 1149.1 specification requires that a compliant Boundary-Scan device be initialized to a known starting state; in this case, the starting state is the Test Logic Reset State. That state can be reached by simply clocking tck a total of five times while tms is high. However, the standard also specifies that the device can be optionally reset independently of tms and tck . That can be accomplished by adding power-up-reset circuits on-board the Boundary-Scan device. The other alternative is to add the additional external $trst$ pin to the device.

The TAP Controller. The TAP controller, as previously mentioned, is actually a 16-stage finite-state machine that operates according to the state diagram shown in Fig. 6. State names that include "-DR" are data-register operations; that is to say, the controller performs some function (determined by the instruction register) on one of the selected data registers. The state-names that include "-IR" are instruction-register operations. While in an IR state, the controller is performing an operation on the instruction register.

The logic condition shown next to the state names (the 1's and 0's) indicate the value that the Test Mode Select (tms) must have on the rising edge of the next tck in order to proceed to the next state. One cycle of TAP Controller sequencing is defined as tck rising to a logic 1 and then falling to a logic low.

The main state diagram consists of six steady states; Test-Logic-Reset, Run-Test/Idle, Shift-DR, Pause-DR, Shift-IR, and Pause-IR. It is important

to note that only one steady state exists for the circumstance when tms is set to a logic 1: the Test-Logic-Reset state. This means that a reset of the Boundary-Scan device can be accomplished within five cycles of tck by setting the tms to a logic 1.

At power up or during normal operation of the host IC, the TAP is forced into the Test-Logic-Reset state by driving tms high and applying five tck cycles. In this condition, the TAP issues a reset signal that places all of the test logic into a condition that allows normal operation of the core logic. When a test is desired, a logic sequence is input via the tms and tck inputs, causing the TAP to exit the Test-Logic-Reset state and travel through a series of designated TAP states.

The states of the Data- and Instruction-Register sequence blocks are exactly the same. The first action that occurs when either section is entered is the capture operation. For the Data Registers, the Capture-DR state is used to capture (or parallel load) the data into the selected serial-data path. If the Boundary-Scan Register (BSR) is the selected Data Register, the normal data inputs are captured during this state and transferred into the BSR. In the Instruction Register, the Capture-IR state is used to capture status infor-

mation of the Boundary Scan part into the Instruction Register.

From the Capture state, the TAP moves to either the Shift or Exit1 state. Generally the Shift state follows the Capture state so that test data or scan information can be shifted out for examination and new test data shifted in. After the Shift state has been completed, the TAP either returns to the Run-Test/Idle state through the Exit1 and Update states or moves to the Pause state by way of Exit1. The reason for entering the Pause state is to temporarily halt the shifting of scan information through either the Data or Instruction Register while a required operation, such as refilling a tester memory buffer, is performed. From the Pause state shifting can be restarted by moving back to the Shift state by way of the Exit2 state or it can be left by transitioning to the Run-Test/Idle state through the Exit2 and Update states.

IEEE 1149.1 Registers. There are several required and optional registers specified in the IEEE 1149.1 standard. Those are: the Instruction Register, the Boundary-Scan Register, The Bypass Register, and the Device Identification Register. Let's look at them next.

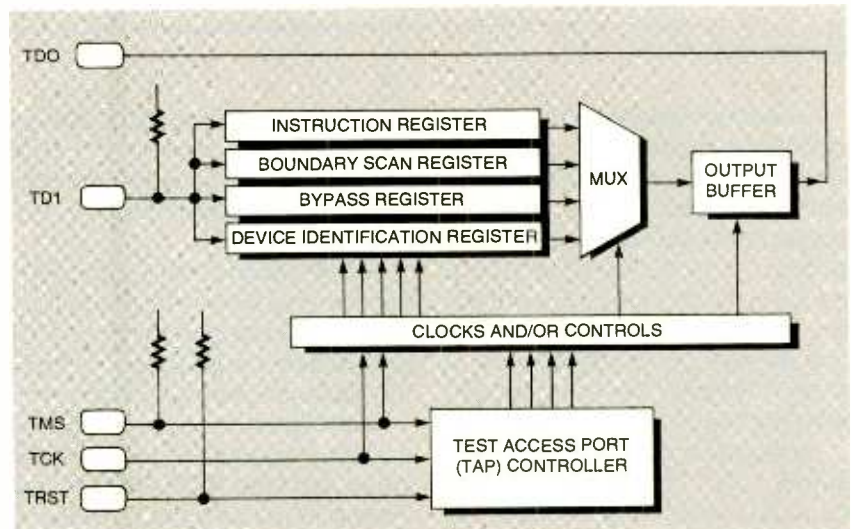

Fig. 5. The top level schematic is comprised of three functional blocks—the TAP controller, the instruction register, and the test data registers. Those three circuit blocks are connected to four, or optionally, five input/output signals that control the operation of the Boundary-Scan circuits. Those signals are: test clock input, test mode select, test data input, test data output, and the optional test reset.

The Instruction Register (required) provides the address and control signals needed to connect a particular Data Register into the scan path. The Instruction Register is accessed when the TAP receives instructions to enter the IR-scan mode.

input to the TDO output.

The Instruction Register supplies the address that enables one of the Data Registers to be accessed during a TAP controller Data Register scan state. During a Data Register state execution, a control output from the TAP selects the output of

For example, suppose you had a set of scan ICs connected as shown in Fig. 7A. If all of the Boundary Scan Cells are selected, the total length of the scan chain would be 24 bits. If you only wanted to test the middle IC in the scan path, you could set up the scan path so that the first and the last IC would only have a 1 bit bypass scan path (Fig. 7B). That would result in a much shorter scan chain of 10 bits (8 bits for the middle IC and 1 bit each for the other ICs). As far as test time is concerned, it's 58% faster to shift in 10 bits than it is to shift in 24 bits. Moreover, it is a lot easier to generate, and keep track of, a 10-bit test pattern than a 24-bit test pattern. That becomes more of a concern when one considers that the average 586 (Pentium) microprocessor contains around 170 Boundary-Scan cells.

The Bypass Register is selected when the Instruction Register is loaded with a pattern of all ones.

The Device-Identification Register is an optional register used to identify the device's manufacturer, part number, revision, and other device-specific information. Those bits can be scanned out of the Identification Register after being selected. This is very useful for verifying that the correct part is installed into a particular socket.

Required Instructions. The IEEE 1149.1 standard specifies nine test instructions for use with the TAP controller. Three are required to be present in every Boundary-Scan device. Six of those instructions are optional. The required commands are BYPASS, SAMPLE/PRELOAD, and EXTEST. Optional instructions are INTEST, RUN-BIST, CLAMP, HIGHZ, IDCODE, and USERCODE. The required instructions are described below.

The BYPASS instruction allows the IC to remain in a normal logic operational mode and connects the Bypass Register between TDI and TDO. The BYPASS instruction allows serial data to be transferred through the IC from TDI to TDO without affecting the operation of the IC. The op-code of this instruction is all ones.

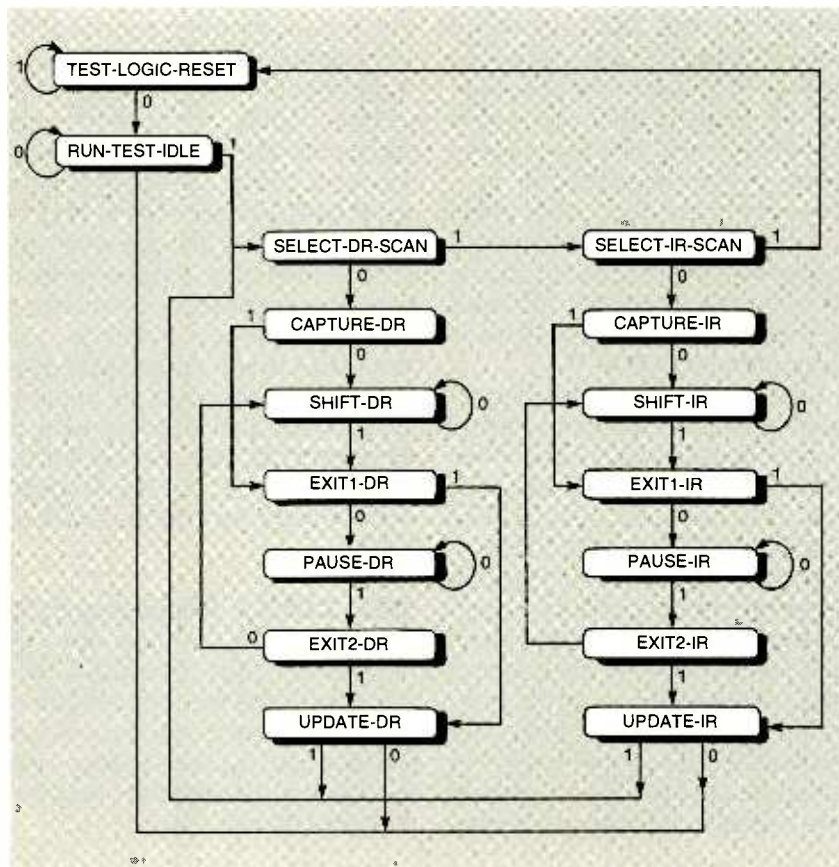

Fig. 6. The TAP controller is actually a 16-stage finite-state machine that operates according to the state diagram shown here.

The Instruction Register consists of a FIFO shift register and an instruction shadow latch. If the TAP signal RESET* is enabled, the TAP controller sets the instruction shift register to be all logic 1's. That forces the Boundary Scan IC into the normal function mode and connects the Bypass Register (or the Device Identification Register if one is present) between the TDI and TDO.

There are two Data Registers in an IEEE 1149.1 device. They are the Boundary-Scan Register and the Bypass Register, with an optional third register, the Device-Identification Register. Those Registers are arranged in parallel from the TDI

to the Data Register to drive the TDO pin. When one path in the Data Registers is being accessed, all other Data Register paths remain in their present state.

The Boundary-Scan Register (BSR) consists of a series of Boundary-Scan cells (BSCs) arranged to form a scan path around the boundary of the IC. This has been previously explained.

The Bypass Register (required) consists of a single scan register bit. When enabled, that Register provides a single bit path between TDI and TDO. The Bypass Register allows condensing the scan path through scan devices that are not involved in a current test.

The SAMPLE/PRELOAD instruction allows the IC to remain in its normal logic mode and enables the Boundary-Scan Register so that it is coupled between TDI and TDO. During this instruction, the Boundary-Scan Register cells can be analyzed by commanding the TAP to enter a data scan state. That instruction is also used to preload test data into the Boundary-Scan Register cells prior to executing the EXTEST command. The op-code for this instruction is defined by the IC manufacturer and will appear in the data sheet for the device.

The EXTEST instruction, as previously shown, puts the device into an external test mode and connects the Boundary-Scan Register between TDI and TDO. During that instruction, the Boundary-Scan Register cells are made to drive test data out the physical IC pins. Also, the BSCs receive external test data by way of the IC's physical input pins. The op-code of this instruction is all zeros.

Scan It Yourself. So far we have discussed the basic concept of Boundary Scan and the basic architecture that makes that test method work. However, there is much more that can and should be learned by test technicians, repair people, and digital designers. For instance, there are detailed techniques that allow the identification of any TAP that fails in the scan path and there are methods to detect mis-socketed or wrong parts in the scan chain. There is even a systematic approach for detecting faulty TDI and TDO lines. In fact, there have been several really thick (and really good!) books written on all kinds of Boundary Scan subjects.

But, too much information at one time is not necessarily good. What we need to do at the present time is practice, practice, and practice, and now you are ready for some hands-on experience.

The best way to learn is to "do-it-yourself" using real Boundary-Scan devices. Many companies today manufacture and distribute

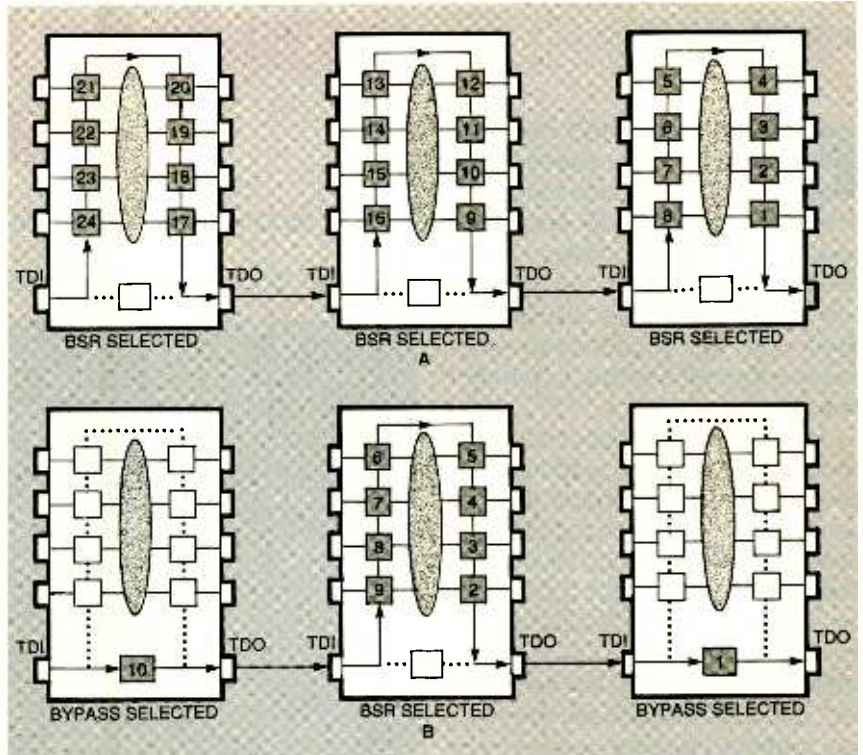

Fig. 7. The Boundary Scan is 24 bits long when each of the three Boundary-Scan Registers is selected as shown in A; it is 10 bits long when two of the ICs are in the Bypass mode as shown in B.

Boundary Scan Training packages. Because the cost of those packages range from several hundred to several thousand dollars, they are often out of the reach of most technicians and electronic students.

An elegant and inexpensive solution to that problem can be found by obtaining a free copy of the very impressive SCAN EDUCATOR interactive and multimedia training program. That program contains several simulated scan devices and it allows the user to freely explore the world of IEEE 1149.1. SCAN EDUCATOR is available, free of charge, from Texas Instruments on the world wide web at the following location: <http://www.ti.com/sc/data/jtag/scanedu.exe>.

In addition to the SCAN EDUCATOR, Boundary Scan IC parts are available from the author. The parts kit includes a 3.5-inch disk copy of the SCAN EDUCATOR, two SN74BCT8244 Octal Boundary Scan ICs, and 19 pages of Boundary Scan data sheets. Data sheets include a description of the SN74BCT8244 scan part, all op-codes, instructions, and plenty of

logic timing diagrams. This kit is available for \$21.60, check or money order, postpaid. Order from J. Daniel Connell, 10263 Gandy Blvd., North, Box 2408, St. Petersburg, FL, 33702.

For More Information. To learn more about the IEEE 1149.1 standard, refer to the publication, *Standard Test Access Port and Boundary-Scan Architecture*, IEEE Std 1149.1-1990 (includes IEEE Std 1149.1a-1993). That document is available through the IEEE (Tel: 1-800-678-IEEE, 908-981-1393), and is also available on CD-ROM. In addition to that, a very nice tutorial *The Test Access Port & Boundary Scan Architecture* by Colin M. Maunder & Rodham E. Tulloss, is available from the IEEE Computer Society Press, Customer Service Center, 10662 Los Vaqueros Circle, P.O. Box 3014, Los Alamitos, CA, 90720-1264. An additional book, *IEEE 1149.1 Testability Primer* is available, upon request, from your local Texas Instruments distributor. Check the Texas Instruments Web site (<http://www.ti.com>) for a dealer near your location. Ask for publication S5YA002B. Ω

BENDING THE FUTURE OF SEMICONDUCTORS

Learn how researchers have put a whole new twist on semiconductor technology.

Electrical engineers have bent over backwards meeting the demand for smaller, faster and cheaper semiconductor chips. Now researchers have stumbled on the design of a semiconducting material that bends over backwards itself—the first single-crystal semiconductor that bends but does not break.

These semiconductors, some made with ordinary weather-stripping silicone, are so flexible you can peel them off their substrates like address labels, say the University of Buffalo (UB) researchers that developed them. "When we think of semiconductors we think of a crystal, something very hard and very fragile," said lead researcher Hong Luo, an assistant professor of physics at the University of Buffalo. "But these semiconductors can bend like rubber."

Despite their pliability, the new components retain both their structural integrity and their optical properties, characteristics that make them particularly useful in the future of optical computing, where data is carried by waves of light instead of streams of electrons. For example, the new semiconductor discovery will allow for optical waveguides—the optical computing equivalent of wires—and semiconductors to be contained inside the same component.

Their flexibility also makes it possible to transmit optical signals in three-dimensional optical circuits, making their applications far more efficient and allowing for far more versatile design than is currently possible with two-dimensional light transmission. "These semiconductors could help expedite the transition from electronics to optical computers by allowing us to exploit optics in semiconductors much more efficiently than has been possible," said Luo.

Other applications for optical waveguides are expected to be found in telecommunications and in high-efficiency solar cells for the mil-

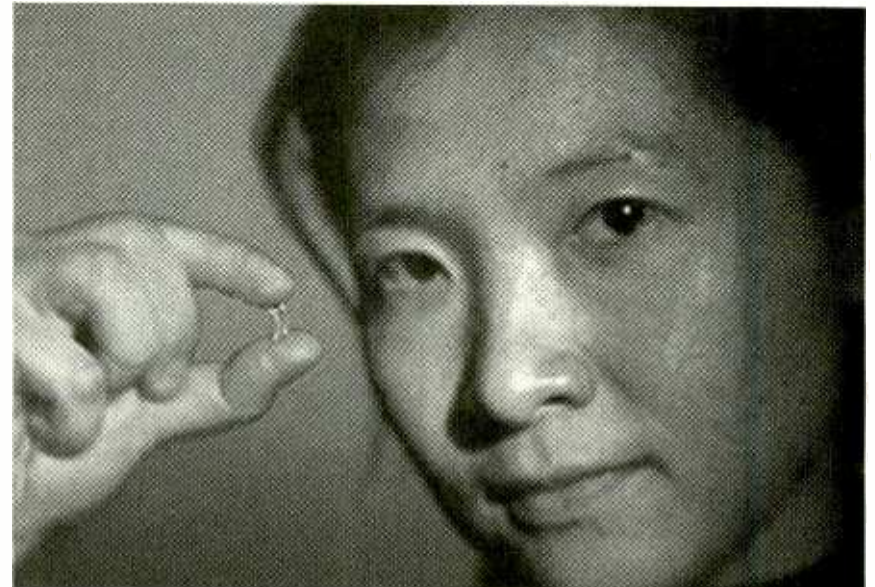

The first flexible semiconductor to retain its optical and structural properties is shown here by Myung-Hee Na, a physics graduate student at the University of Buffalo, where the device was developed. (Frank Cesario/University of Buffalo)

itary, where the flexibility feature will be attractive in withstanding the stress of rocket launches and battlefield commotion. "We have developed a general technology to be used with all semiconductors," Luo said.

How They Are Made. The new semiconductors are flexible because they are deposited on substrates in thin layers using molecular-beam epitaxy (MBE), a technique involving the deposition of thin films on substrates in an ultra-high-vacuum chamber. That technique is particularly suited to the growth of compound semiconductors. The high vacuum assures the highest levels of purity.

"Theoretically, if you could make it thin enough, even a diamond could be flexible," Luo explained. "But such thin materials are, of course, extremely fragile. They need to be supported by something, which makes this a problem for

physics. We have to figure out a way to give mechanical support to this type of semiconductor structure."

Using MBE, Luo and UB physicist colleague Athos Petrou grew quantum wells—structures that are so thin they obey the laws of quantum physics, not classical physics. The wells were grown out of zinc selenide and zinc cadmium selenide on gallium arsenide, a typical semiconductor substrate.

Then the MBE-grown sample was bonded to the silicone and the gallium arsenide etched away. What remained was a one-micron thick quantum-well structure on top of the silicone.

A Fortunate Accident. Like a surprising number of new advances, the flexibility characteristic of the semiconductor was discovered accidentally by Luo and Petrou's graduate students. "They were trying to glue the semiconductor to another piece of semiconductor,

but it didn't glue very well and just came off," Luo said. "They thought it was ruined." The next day, when the researchers performed optical testing on the material, to their surprise all of its optical and structural properties were found to be intact.

Luo said that while other semiconductor work has achieved flexibility using inexpensive polymeric materials, they have not always performed as well as inorganic semiconductors in their ability to emit light or to maintain structural integrity. "The flexible semiconductors we've developed are man-made structures that are fabricated using conventional semiconducting elements," he said. "Such materials possess superior optical properties and can be combined with polymeric materials because both are flexible."

The semiconductors fabricated at UB are only about one centimeter in diameter, but the researchers said industrial facilities should be able to adapt the technology to the construction of samples up to five inches or larger in diameter. Ω

BEAM ROBOT

continued from page 48

solar-cell array, SCR1 will stay turned on, and the circuit will not recycle.

The solar cell and SCR used in the circuit are balanced for proper operation. You might need to redesign the circuit in order to use solar-cell arrays that can supply greater current.

One component you might want to change is C2. You can use a larger value to store additional power. Be aware that if you do that, it will take longer for the circuit to cycle.

As you learn more about BEAM robotics, you'll find that layering many different response circuits can create very complex behavior patterns. Who knows—you might even be the winner at the next BEAM Olympics! Ω



Discover DC Electronics

17-Module Course -- Only \$49.95

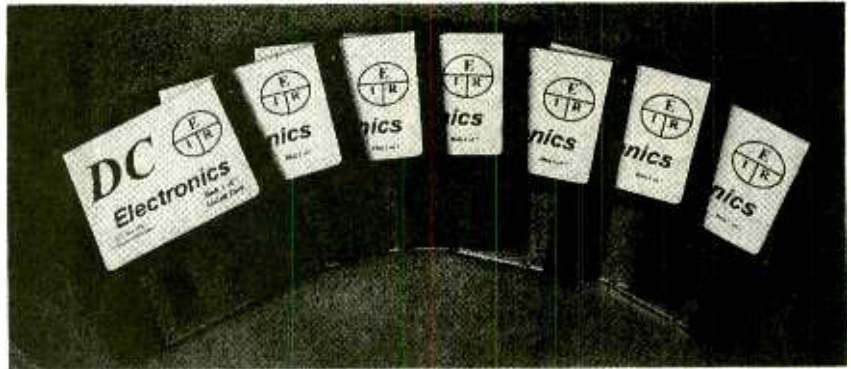

Contains everything you ever needed to know about DC electronics. Whether you are a professional working in electronics and you want a review of the basics, or a student or hobbyist new to this field and need a good self-paced course, this is the perfect way to get started.

The course starts with basics and assumes you know nothing about electronics. It teaches the required math, how to use a scientific calculator, and the metric notation system. Each module has been written by an electronics instructor, and will directly from a floppy or from a menu-driven system on your hard drive. Every module includes a review, summary, quiz, and a final exam that can be printed out. Important points are animated to make the explanation clear.

System requirements: IBM Compatible, 512K RAM, VGA Color, Hard Drive and DOS 3.2 or newer.



Here are the Modules

- | | |
|---|---|
| 1. Atoms and Electrons | 10. Series / Parallel Circuits |
| 2. Volts / Current / Resistance | 11. Voltage Dividers |
| 3. Numbers greater than one
Scientific - metric notation | 12. Kirchhoff's Law |
| 4. Numbers less than one
Scientific - metric notation | 13. Advanced DC Circuit
Analysis |
| 5. Resistor Color Codes | 14. Capacitors / RC Time
Constants |
| 6. Using Calculators | 15. Introduction to Magnetism |
| 7. Ohms Law and Power | 16. Inductors and L/R Time
Constants |
| 8. Series Circuits | 17. Volt/Ohm/Current Meters |
| 9. Parallel Circuits | |

Claggk Inc. P.O. Box 4099, Farmingdale, NY 11735

Send me my course, today! Charge me the special introductory price!

Name _____ \$49.95 + \$4.95 shipping

Address _____

Address _____

City _____ State _____

Zip _____

Payment Enclosed \$ _____

Check Money Order Credit Card

New York residents add local sales taxes. Canadians add \$6

per order. Credit card orders by phone or fax. Automated

telephone orders 516-293-3751. Fax 516-293-3115.

Allow 4 to 6 weeks for delivery.

Credit Card Info

MC Visa

Card # _____

Exp Date _____

Signature _____

AUDIO UPDATE

continued from page 26

stand the test procedures, they are all easy to use. For most audio testing, knowledge and practice will make you an expert. I have personally performed all of the audio tests we will be discussing hundreds, if not thousands, of times during my career. When I started in audio some 35 years ago, I was a complete novice. In time, sometimes by trial and error, I learned what needed to be done and what each particular reading I took meant. I am going to try and pass that information on to you over the coming months.

As we proceed, we'll do everything in simple terms. This is not a college course in design. This month, we'll look at each instrument in general terms and show only simplified schematics. In future installments, we'll flesh out each instrument, give you the information you need to put it together yourself if you don't already own one, and show you how to use it in the most effective way. All of the instrument designs are tried and tested. They will be available in kit form for those who do not have the time or desire to search out the parts.

Audio Source

The first instrument needed for audio testing is an audio source. A sinewave generator is vital. It will deliver the signals you need for 95% of all the audio testing you do. There are several different kinds of circuits that can be used to generate sinewaves. They include Wien-bridge, bridged T, and phase-shift oscillators. I have selected the Wien-bridge circuit for use in the instrument we will be building.

There are several reasons for making this choice. A Wien bridge oscillator can be built with simple precision components and FET stabilization to reduce the third-harmonic distortion (THD). The lower we keep the THD, the better the measurements we can make. The instrument we build will have a range of frequency bands, and a selection of output levels to 10 dB, in 1-dB steps. The basic diagram for the oscillator is shown in Fig. 1.

Audio Voltmeter

The second most used instrument is the audio voltmeter. Again, there are several ways to construct such an instru-

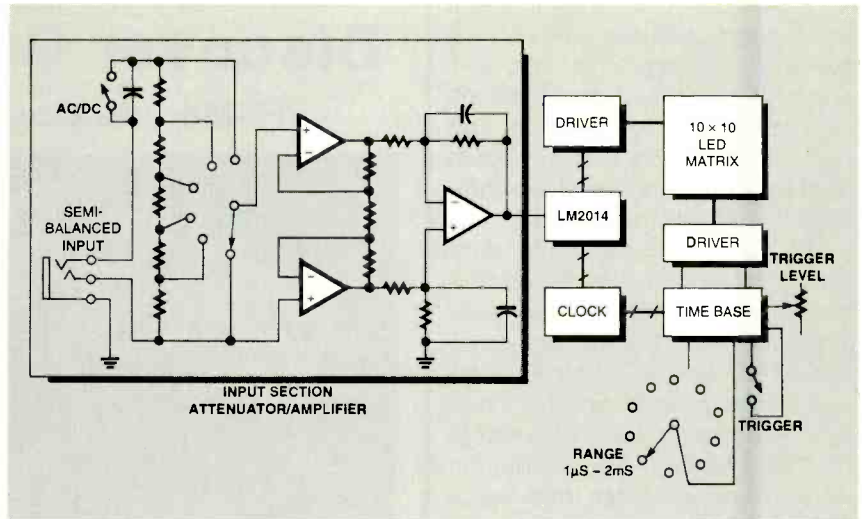

FIG. 3—WHILE THIS SIMPLE LED OSCILLOSCOPE does not have the bandwidth or capabilities of high-end units, it can be built at a reasonable cost and is more than sufficient for our needs.

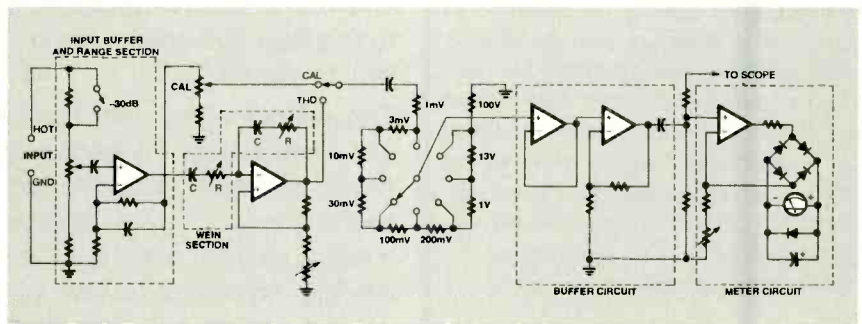

FIG. 4—OUR DISTORTION ANALYZER, which measures THD plus noise in an audio system, is built around a Wien nulling network.

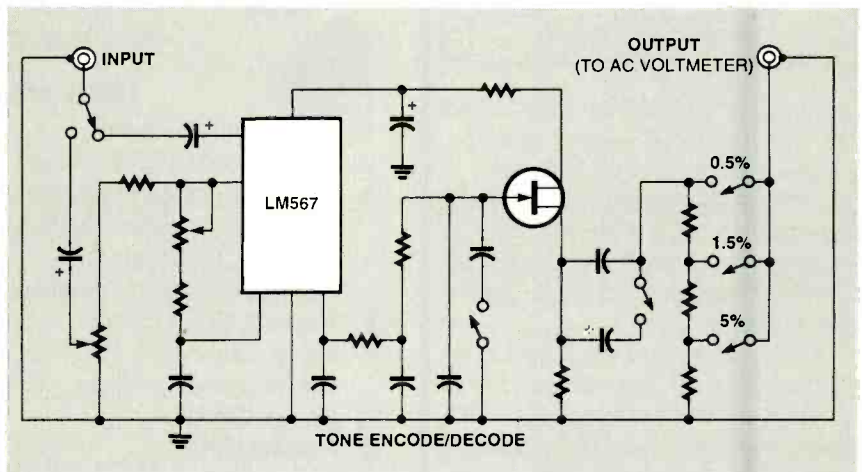

FIG. 5—IF YOU PLAN ON WORKING with audio-tape decks, this wow-and-flutter meter will prove indispensable.

ment. We do, however, have to find a balance between very high accuracy and reasonable cost. The meter we will build has an adjustable input span of 70 dB, in four ranges.

Figure 2 shows the basic diagram for the instrument. Remember, if our readings are off by 1 dB, it really won't affect

the total readings that much, as we will be trying to solve the gross problems that exist and not use this instrument for minor refinements.

Oscilloscope

A good scope will often show us *continued on page 69*

Measuring Power, A Cheap Extension Lock Out, A Correction, and More

JUST WHEN YOU FIGURE YOU'VE BEEN AROUND LONG ENOUGH TO SEE JUST ABOUT EVERYTHING, SOMETHING NEW OR DIFFERENT COMES ALONG TO MESS YOU UP OR OTHERWISE EMBARRASS YOU. CASE IN POINT ARE THOSE BRAND NEW BABY

PICs from Microchip Technology. It turns out that they have highly unusual supply pins, especially for an eight-pin minidip.

There is a rule of thumb with this type of package that states that the highest pin is positive and the diagonally opposite pin is ground. Unfortunately, that rule is violated with these chips. Well, to make a long story short, a quick glance showed that pin 1, where I expected to find the positive supply, was labeled Vee-sub-something-or-other. Trouble was, it was V_{SS} , which, of course, is grounded. The positive supply pin, V_{DD} , was actually pin 8.

The moral of this story is that you should always carefully read the exact data sheet to make sure of all pin outs, especially before powering up your chip or even starting your PC-board layout. At any rate, Fig. 1 of the February 1997 installment of "Tech Musings" had the baby PIC pins backwards. I have corrected that in MUSE108.PDF on www.tinaja.com and in my Tech Musings reprints. Sorry about any inconvenience that might have been caused.

By the way, this is not the only part out there that could cause similar grief over backwards pins. For instance, in the National LM324 quad op amp, the positive supply goes to pin 4, while ground goes to 11, the exact opposite of what you might expect. Again, always double check before you power up any device.

Measuring Power

It is amazing how much trouble people can get themselves into when they don't have the foggiest clue how to make the most fundamental of AC power measurements. Especially as beginning lab students or whenever making absurdly wrong claims about circuit efficiencies.

If you try to measure AC or pulse circuit power using a voltmeter and an ammeter, your results will nearly always be utterly wrong, especially when phase shifts, harmonics, or any unusual waveforms are involved. It is trivially easy to create errors of 400 percent or higher, and never in your favor, of course.

The fundamental equation appears simple enough:

$$\text{watts} = \text{volts} \times \text{amps}$$

To find your power, you multiply your volts times your amps, right? Wrong! That equation only will work when you multiply instantaneous voltage times instantaneous amperage. In other words, your volts and amps must be in the same

place at the very same instant. They must not change while you are doing the measurement.

The only correct way to measure power is to multiply an instantaneous voltage times instantaneous current, measured over some very brief time increment. Then, you sum all of those incremental measurements to find the longer term average power. Finally, you need to find what equivalent, continuous DC current is required to produce an identical value of average power. That equivalent, continuous DC current is also called the rms current, which is short for root-mean-square.

Circuits are the easiest to analyze when you normalize them. Let's start with a simple case. Assume we have a purely resistive one-ohm load. By Ohm's law, with a one-ohm load, the rms current will equal the square root of the average power.

Let's further assume we have a low distortion AC source that is a pure fundamental-frequency sinewave. Let us work with a positive half cycle of that sinewave.

Figure 1 shows us how we can crudely approximate a half sinewave using five rectangular steps. We take each step's current and average it to get the average current of 0.65. Next, we sum the currents squared to find each step's power, and then we divide by five (the number of steps) to find the average power. We take the square root of the average power to get the rms current of 0.71 for this waveform.

The figures we've derived for average and rms current are fair approximations of the true values, but are not exact. If we use more steps, we can get closer to the "real" answers. There's a neat-o math stunt known as integral calculus

NEED HELP?

Phone or write all your US Tech Musings questions to:

Don Lancaster
Synergetics
Box 809-EN
Thatcher AZ, 85552
Tel: 520-428-4073

US email: don@tinaja.com
Web page: <http://www.tinaja.com>

**new from
DON LANCASTER**

ACTIVE FILTER COOKBOOK

The sixteenth (!) printing of Don's bible on analog op-amp lowpass, bandpass, and highpass active filters. De-mystified instant designs. \$28.50

CMOS AND TTL COOKBOOKS

Millions of copies in print worldwide. THE two books for digital integrated circuit fundamentals. About as hands-on as you can get. \$28.50 each.

**INCREDIBLE SECRET
MONEY MACHINE II**

Updated 2nd edition of Don's classic on setting up your own technical or craft venture. \$18.50

LANCASTER CLASSICS LIBRARY

Don's best early stuff at a bargain price. Includes the CMOS Cookbook, The TTL Cookbook, Active Filter Cookbook, PostScript video, Case Against Patents, Incredible Secret Money Machine II, and Hardware Hacker II reprints. \$119.50

LOTS OF OTHER GOODIES

Tech Musings V or VI	\$24.50
Ask the Guru I or II or III	\$24.50
Hardware Hacker II, III or IV	\$24.50
Micro Cookbook I	\$19.50
PostScript Beginner Stuff	\$29.50
PostScript Show and Tell	\$29.50
Intro to PostScript Video	\$29.50
PostScript Reference II	\$34.50
PostScript Tutorial/Cookbook	\$22.50
PostScript by Example	\$32.50
Understanding PS Programming	\$29.50
PostScript: A Visual Approach	\$22.50
PostScript Program Design	\$24.50
Thinking in PostScript	\$22.50
LaserWriter Reference	\$19.50
Type 1 Font Format	\$16.50
Acrobat Reference	\$24.50
Whole works (all PostScript)	\$380.00
Technical Insider Secrets	FREE

POSTSCRIPT SECRETS

A Book/Disk combination crammed full of free fonts, insider resources, utilities, publications, workarounds, fontgrabbing, more. For most any PostScript printer. Mac or PC format. \$29.50

BOOK-ON-DEMAND PUB KIT

Ongoing details on Book-on-demand publishing, a new method of producing books only when and as ordered. Reprints, sources, samples. \$39.50

THE CASE AGAINST PATENTS

For most individuals, patents are virtually certain to result in a net loss of sanity, energy, time, and money. This reprint set shows you Don's tested and proven real-world alternatives. 28.50

BLATANT OPPORTUNIST I

The reprints from all Don's Midnight Engineering columns. Includes a broad range of real world, proven coverage on small scale technical startup ventures. Stuff you can use right now. \$24.50

RESOURCE BIN I

A complete collection of all Don's Nuts & Volts columns to date, including a new index and his master names and numbers list. \$24.50

FREE SAMPLES

Check Don's Guru's Lair at <http://www.tinaja.com> for interactive catalogs and online samples of Don's unique products. Searchable reprints and reference resources, too. Tech help, hot links to cool sites, consultants. email: don@tinaja.com

FREE US VOICE HELPLINE VISA/MC

SYNERGETICS
Box 809-EN
Thatcher, AZ 85552
(520) 428-4073

CIRCLE 205 ON FREE INFORMATION CARD

The **AVERAGE CURRENT** of a waveform is found as you would find any other average. Take narrow samples. Add each sample value, then divide by the number of samples. Here is a five step approximation to a half sinewave...

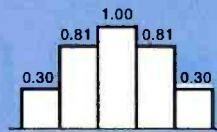

$$\begin{aligned} \text{average current} &= \\ &= (0.30 + 0.81 + 1.00 + \\ &+ 0.81 + 0.30)/5 = 0.65 \end{aligned}$$

The **AVERAGE POWER** of a waveform driving a one ohm resistive load is found by squaring the current of each sample and summing them...

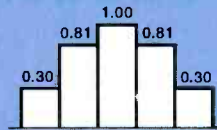

$$\begin{aligned} \text{average power} &= \\ &= ((0.30)^2 + (0.81)^2 + (1.00)^2 + \\ &+ (0.81)^2 + (0.30)^2)/5 = 0.50 \end{aligned}$$

The **RMS CURRENT** of a waveform is the equivalent dc current you'll need to produce the same average power. For a one ohm resistive load, RMS current is found by taking the square root of the average power...

$$\text{RMS current} = \sqrt{\text{average power}} = \sqrt{0.50} = 0.71$$

For more accuracy, calculus integration is often used instead...

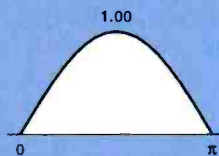

$$\text{average current} = \frac{1}{\pi} \int_0^{\pi} \sin(\theta) d\theta = 0.637$$

$$\text{average power} = \frac{1}{\pi} \int_0^{\pi} \sin^2(\theta) d\theta = 0.500$$

$$\text{rms current} = \sqrt{0.500} = 0.707$$

Average current is highly wave shape dependent. Average current often will be a grossly misleading and totally useless way to try and measure circuit power. For accurate results, true rms measurements must -always- be made.

FIG. 1—THE RMS CURRENT of any waveform is the exact amount of continuous current you have to apply to get the same average power.

that can let you sum up an infinite number of infinitely narrow steps, giving us the "real" answers: a sinewave's average current is 0.637 peak, and its rms current is 0.707 of the peak value. You can find more on this in an introductory AC circuit-theory book.

Incidentally, plain old analog AC panel meters measure an average current. Further, those wrongly assume that you always have a continuous and low-distortion fundamental-frequency sinewave and simply fudge their results by multiplying all meter readings times 1.11072, a number that only relates the ratio of the average current and rms current of a clean half sinewave. If you do not have such a waveform, the reading is wildly low.

Three Mistakes

When it comes to measuring power, there are three mistakes that most beginners usually make:

1) **Assuming the voltage and current are in phase:** Voltage and current will be in phase only in a pure resistive load. They should be 90 degrees out of phase with a pure inductive or pure capacitive load. And they should be 180 degrees out of phase when you are actively sourcing rather than sinking current. In short, any phase from 0 to 360 degrees could be encountered with a real world load. You can find more on this in MUSE100.PDF on www.tinaja.com.

For example, say you have a typical linear AC load driven from a clean sinewave, and you measure 100 volts and 3.0 amps with a pair of panel meters. Depending on the phase, the wattage could end up being anything from minus 300 watts through 0 to plus 300 watts. There is simply no way to correctly measure AC power using an ordinary voltmeter and ammeter! Do not even think of trying it!

2) Assuming a clean sinewave: Whenever you are using parts of sinewaves (as in an AC power controller) or pulses, then you **must** use some “true” rms current-measurement scheme, which is not trivial. There’s two main routes to handle weird waveforms: You can apply rectangular approximations or math calculus to analyze the rms to average ratio, or you could use Fourier Series to deal with the waveform as a fundamental sinewave plus its significant odd and even harmonics. More on this can be found in MUSE90.PDF on www.tinaja.com.

Measuring the current of a train of pulses using any analog panel meter will give us wildly wrong answers. Figure 2 shows us why your meter reading will be both way low and dead wrong every time. Let’s consider a train of repeating pulses. If we assume a 1-volt supply and a 1-ohm resistive load, a squarewave will have a duty cycle of 1:1, the average current will be 0.5 amp, and your average power will be 0.5 watt. The rms current will be the square root of the average power, or 0.707. Your rms current will equal 1.414 times the average current.

Next, consider a pulse with a 19:1 duty cycle. The average current will be 0.05 amp and the average power will be 0.05 watts. Your rms current will again be the square root of your average power, or 0.22361. This time, your rms current ends up a whopping 4.472 times the average current. Which means that a typical meter current reading will measure low by a factor of four or so! A crest factor (or the peak-to-rms ratio) is one measure of how extreme a waveform is. That 19:1 duty cycle pulse has a very high crest factor of 4.47. Just about all true rms current measurement schemes place definite limits upon how high a crest factor is permitted. Exceed their crest-factor limit and your results will miss by a country mile.

3) Ignoring waveform harmonics: Weird waveshapes get their shape by having lots of higher harmonics. On any low duty cycle pulse, the lion’s share of the energy lies in the harmonics and not in the fundamental. Dozens and sometimes hundreds of harmonics could end up being important. Your power company tends to get very upset when you draw harmonic energy instead of using fundamental energy. Such waveforms are now, in fact, illegal in Europe.

rms Options

How can you measure rms current or

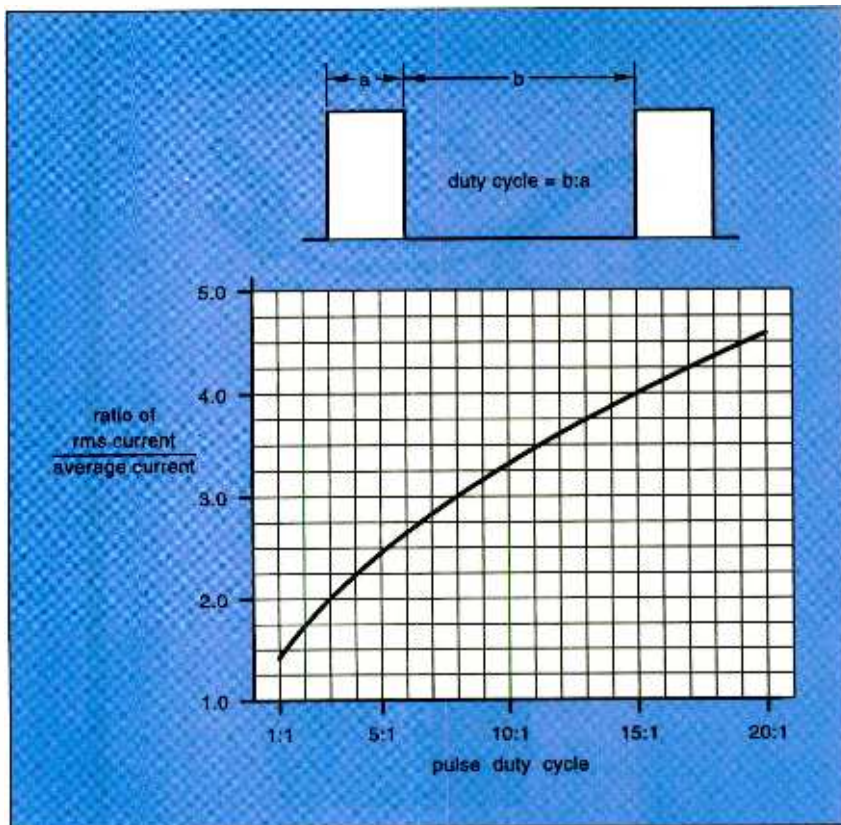

FIG. 2—LOW DUTY CYCLE PULSES might involve surprisingly low average currents. Their power can only be measured by using premium, “true rms” instruments. Ordinary panel meters and VOMs are all average responding, giving you absurdly low results that are certain to be dead wrong.

calculate real power? As we’ve seen, for typical measurements made most of the time, reading a voltmeter and an ammeter and multiplying the two together will not hack it, especially with bizarre waveforms, high harmonics, pulses, when there are phase shifts between voltage and current, or when you don’t know the exact waveform you are looking at. In all of those cases, most any dual meter measurement will just about always be dead wrong. One reason is that any traditional panel meter is an average measuring device, and the product of some average most assuredly will not equal the average of the products.

Instead, you have to ask “what is the equivalent DC current you need to get the same quantity of consumed power?” As we have just seen, this equivalent DC current is also called the rms current. Measuring true rms current never has and never will be easy, as there is layer upon layer of subtlety. To do the task, there are four popular rms measuring techniques. They are heat matching, the graph method, multiply and average, and math rule. Let’s look at those.

1) The heat method: Make your cur-

rent waveform heat a resistor. You take a second resistor that’s under identical thermal conditions and then route an adjustable DC current to it. When the temperatures match, the rms currents will exactly match. A bolometer is one example of a microwave method of measuring rms currents or power levels using that technique.

2) The graph method: First obtain accurate waveforms of your voltage and current. Divide those up into very narrow increments, increments that are so narrow that both the voltage and current remain nearly constant within each interval. Then multiply each interval’s volts times its amps, sum and average all the power from each interval to get the average power, and take the square root of your average power to find the rms current. A digital oscilloscope can greatly simplify that method.

Whenever your load resistance is something different than 1 ohm, you should take the square root of your average power divided by the load resistance. That is known as scaling. You can find more on normalization and scaling in my *Active Filter Cookbook*.

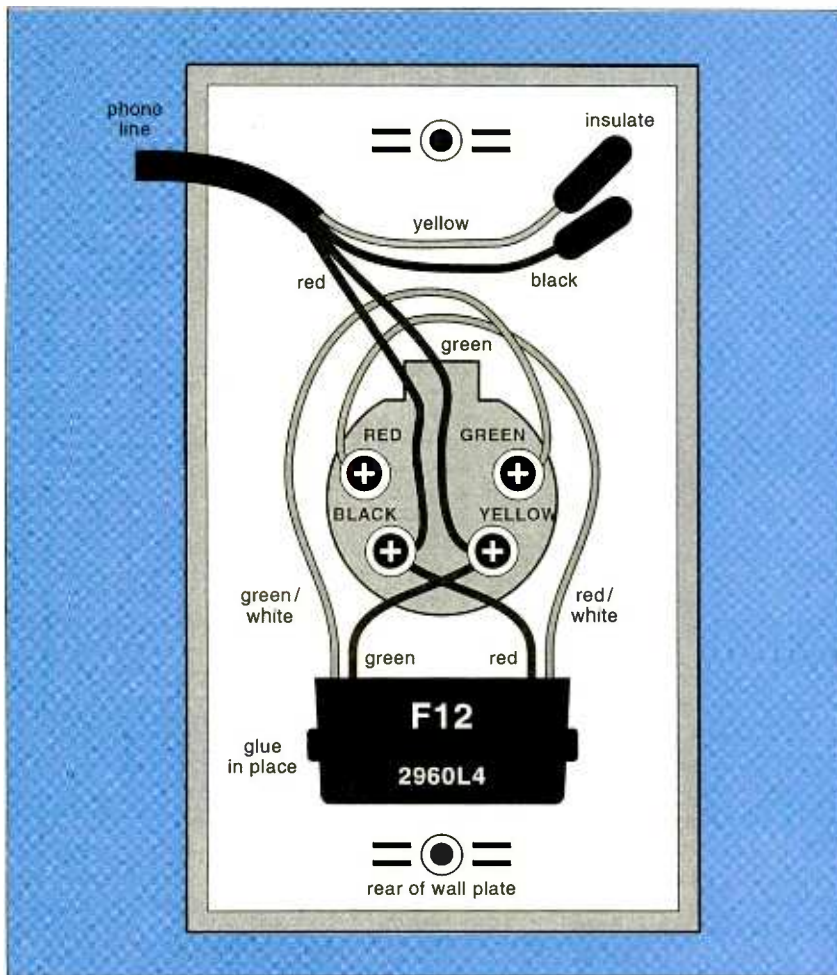

FIG. 3—HERE'S HOW TO INSTALL a 99-cent extension phone lockout. Commercial devices that do the same thing might cost \$11 each, or more.

3) Multiply-and-sum method: Take any fast analog or digital multiplier chip and use it to continuously multiply volts times amps to get instantaneous power. Then sum and average to find the average power. Finally, take the square root of the average power to find the rms current.

Analog Devices is one source for analog multiplier chips optimized for rms current measurement. You can start with their classic AD536A, or use the newer and lower power AD737.

Incidentally, the numbers can get out of hand for even moderately high crest factors. Thus, any commercial rms measurement scheme will always exactly spec the maximum allowable crest factor and it must be observed for accurate and useable results. Fluke and Tektronix are two prime sources of true rms current-measuring test instruments.

4) The rule method: This technique does what we just went through above. You integrate the square of a math-definable waveform to find your average power. Take the square root of your aver-

age power (scaled, if needed, for resistance) to get your rms current. Then find the "correction factor" of the ratio of rms to average power. An ordinary meter could then be used as a temporary stand-in to let you measure rms power. But that method is only accurate on the exact waveform you have just analyzed, and even then only on a purely resistive load.

Note that your "correction factor" will always be considerably higher than 1.11. Watch that detail.

Despite the above, true rms calculations are easy and fun to do using the general purpose PostScript computer language. I've placed a FINDRMS.PS file to both the Math Stuff and the PostScript library shelves of www.tina-ja.com. There's also a new FINDFOUR.PS file that does a complete classic Fourier harmonic analysis of your chosen waveforms.

An Aside

Note that your average current is always waveform dependent! Figure 2

leads us to a rather curious and unexpected result. Assume you have a pair of dimmers or AC phase power controllers. If you connect one to a 110-volt light bulb and the second to a 32-volt light bulb, then light them both to nearly full brightness, your duty cycle will be rather high on the 110-volt bulb and extremely low on the 32-volt bulb.

You would certainly expect that rms current to be the same for both bulbs at identical power levels, since, among other reasons, that is how rms current is defined. But, as Fig. 2 clearly reveals, your average current measures something like three times higher on a 110-volt light bulb! Why?

It's because the average current is duty-cycle dependent and is thus an utterly meaningless measure of the circuit power or efficiency. The FINDRMS.PS program also can show how average current measurement errors vary with Triac phase angle for exact dimmer waveforms.

99-Cent Telephone Extension Lockouts

Picking up your extension phone during a FAX transmission or some online connection can be bad news. So can having someone listen in on your private conversations. To put an end to those problems, you can install an extension lockout between your line and your extension phone to prevent the extension phone from working when the line is in use.

An open phone line is typically around 48 volts DC. Any in-use line drops to 9 volts DC or less. Because of that, a beastie called a bilateral switch can be used as an extension lockout. If there is high voltage on pickup, this switch turns on and allows phone use. If not, it stays off. The switch stays on so long as the extension phone is in use, then resets on zero current.

You can buy a commercial extension lockout for \$11 or so, but I believe I have a more flexible, 99-cent solution you might like better. Back in Tech Musings #96 (*Electronics Now*, February 1996) we looked at a Northern Telecom 2960 network interface. I was pleasantly surprised to find out that unmodified units seem to work just fine for me as extension lockouts—at least on the electronic phones I have around here. Those modules are easily hidden in a wall plate or built into custom gear.

Figure 3 shows the wall-plate setup I

SOME AEROGEL RESOURCES

Airglass AB

PO Box 150
S-24500 Staffanstorp
Sweden

Aspen Systems

184 Cedar Hill Street
Marlborough, MA 01752
(508) 481-5058

Audax of America

10 Upton Drive
Wilmington, MA 01887
(508) 658-0700

Rob Biggar

Cornell Low Temp Group
Ithaca, NY 14853
(607) 255-7179

Ray Cronise

NASA Marshall Center
Huntsville, AL 35812
(205) 544-5493

Dr. Le H. Dao

INRS/Energie et materiaux
Vareennes, Que., Canada J3X 1S2
(514) 929-8144

Harrick Scientific

PO Box 1288
Ossining, NY 10562
(800) 248-3847

Hubert van Hecke

Los Alamos Natl Labs
Los Alamos, NM 87545
(505) 667-5384

Journal of Non-Crystalline Solids

Box 945
New York, NY 10159
(212) 633-7300

Jozef Stefan Institute

Jamova 39
1000 Ljubljana, Slovenija
+386 61 177-3900

LAPP

Chemin de Bellevue, BP 110
74941 Annecy-le-Vieux Cedex
France

Livermore Natl Lab

PO Box 808
Livermore, CA 94550
(510) 422-1100

Lockheed Aerospace

3251 Hanover Street
Palo Alto, CA 94304
(415) 424-2171

Marketech International

5869 Becon Street
Pittsburgh, PA 15217
(412) 421-3103

Matsushita Electric Works

401 River Oaks Pkwy
San Jose, CA 95134
(408) 433-3386

NASA/JPL Group

4800 Oak Grove Drive
Pasadena, CA 91109
(818) 354-4321

NASA Tech Briefs

41 E 42nd St #921
New York, NY 10017
(212) 490-3999

Pamela M Norris

University of Virginia
Engineering & App Sci
Charlottesville, VA 22903

Ocellus Inc

887-A Industrial Road
San Carlos, CA 94070
(415) 596-1408

Physical Review Letters

Box 900
Ridge, NY 11961
(516) 591-4060

PolyStar

6918 Sierra Court
Dublin, CA 94568
(510) 829-6250

Sandia National Labs

PO Box 5800
Albuquerque, NM 87185
(505) 844-5678

Science/AAAS

1333 H St NW
Washington, DC 20005
(202) 326-6400

Super Conductor Mtrls

128 Orange Ave
Suffern, NY 10901
(800) 932-9333

use. This assumes you have a normal electronic phone that needs only the red and green wires. You first free and then separately tape or shrink-wrap both the black and yellow wires coming from the line. You then "borrow" the posts intended for black and yellow and use those to tie the incoming line to the module. Make sure green goes to green and red to red. Solids go to your line and stripes go to your phone side. Only a screwdriver is needed for installation. Any old choice of glue or epoxy or a double stick tape can optionally hold the module to the wall plate. Inline cord setups are also easily built for temporary use. Always place your module immediately before your extension phone, with the striped leads going to the phone end.

I see no reason to expect any serious problems, but if you experience anything strange, try clipping one or both of the internal 150-ohm resistors or cut their

foil traces. There's actually two lockouts inside your module, so you could conceivably control two lines at once by using some simple modifications.

A full schematic and more details on the 2960 appears in MUSE96.PDF on www.tinaja.com. Cheap wall plates and related low-cost phone accessories are available from SS Manufacturing. Radio Shack also stocks lots of this sort of stuff. The 2960 interface modules are available for 99 cents each from my Synergetics Surplus.

Aerogel Update

I finally got to hold an aerogel in my hot little hands. They are amazing objects, especially this one, which was one of the very first to offer absolute crystal clear transparency.

An ordinary gel is a state of matter consisting of solid particles that have been suspended in some liquid, as in

Jello or a gummy bear. However, an aerogel is a state of matter in which solid particles are suspended in a gas. You could think of them as sort of a "solid smoke." Aerogels are often extremely light; some are even lighter than air. They can be outstanding insulators (R50 in half of an inch!), blocking heat and sound while freely passing light. A favorite photo of mine shows a rose on one side of a thin aerogel, which is being torched on its other surface.

Aerogels can be made by freeze drying silicon under vacuum. Carbon aerogels are also possible, including edible ones made from seaweed. Certain carbon aerogels offer an amazing surface to volume ratio. One grape sized aerogel might possess the surface area of two football fields. On the downside, aerogels remain difficult, costly, and time consuming to manufacture. They are often very fragile. Yet some easily support 1500 times their

NAMES AND NUMBERS

Analog Devices

PO Box 9106
Norwood, MA 02062
(617) 329-4700

American Voice I/O Society

PO Box 20817
San Jose, CA 95160
(408) 323-1783

Awards & Engraving

2800 Midway
Bloomfield, CO 80020
(303) 469-0424

Butterworth-Heinemann

313 Washington St
Newton, MA 02158
(617) 928-2500

ENM

5617 Northwest Highway
Chicago, IL 60646
(773) 775-8400

Fluke

PO Box 9090
Everett, WA 98206
(800) 443-5853

Microchip Technology

2355 W Chandler Blvd
Chandler, AZ 85224
(602) 786-7200

Motorola

5005 E McDowell Rd
Phoenix, AZ 85008
(800) 521-6274

National Semiconductor

2900 Semiconductor Rd
Santa Clara, CA 95052
(800) 272-9959

Numeridex

241 Holbrook Drive
Wheeling, IL 60090
(800) 323-7737

SS Manufacturing

135 Commerce Way
Walnut, CA 91789
(909) 595-0450

Synergetics

Box 809
Thatcher, AZ 85552
(520) 428-4073

Tektronix

PO Box 500
Beaverton, OR 97077
(800) 835-9433

Vernier Software

8565 SW Beaverton-Hillsdale Hwy
Portland, OR 97225
(503) 297-5317

own weight. Sadly, most silicon aerogels are water soluble.

What are their uses? Here are some: Insulators of all types, Cerenkov radiation detectors, micrometeorite capturing detectors, sub-atomic particle separators, advanced battery research, honeycombs, ion-beam milling, neutron radiography, refrigerators, skylights, high-energy capacitors, ultralight loudspeakers, desalination of sea water, composite materials, orbital debris collection, superfluids, metal oxide catalysts, thermal protectors, microsphere filtration, exobiology instruments, dielectric materials, oxygen sensors, water deionization, sorbents, calorimeters, and bunches more.

Aerogels are now well beyond the curiosity stage and are producible in larger lab quantities. The production times have been cut from 25 hours to 30 minutes. Mere mortals can access aerogels by asking the right questions in the correct place at the right time in the right manner. Unfortunately, high-volume, low-cost production processes are not yet available and these do seem a tad tricky to make at home with a vacuum cleaner and

some kitty litter. However, I'll award a free *Incredible Secret Money Machine II* to the very first **Electronics Now** reader who sends me a home-brew aerogel.

My particular sample came from NASA's Ray Cronise, a pioneer among the supertransparency aerogel researchers. Clear aerogels are poised to revolutionize efficient windows or building skylights. One place where aerogel stuff is likely to appear is in the *Journal of Non-Crystalline Solids*. Other sources of information include *Physical Review Letter*, *Science* magazine, and possibly *NASA Tech Briefs*.

The web is far and away your best way to explore aerogels. Just use my

EXTENSION PHONE LOCKOUT AVAILABILITY

Type 2960 extension lockouts are 99 cents each plus \$6.50 shipping per order from...

Synergetics Surplus

Box 809-EN
Thatcher, AZ 85552
(520) 428-4073
synergetics@tinaja.com
VISA/MC

"search all sites" feature to reach Alta Vista or Hotbot and key on "aerogel". A superb bibliography on the silicon aerogels appears at eande.lbl.gov/EC/S/aerogels/sabib.htm. I've also included the names and addresses for major aerogel players as this month's resource sidebar.

New Tech Lit

From Motorola, there's a new *Technical and Applications Literature* guide. From National, comes their new *Opamp Databook* and a *Power IC's Databook*.

AVOIS is short for American Voice I/O Society. They have seminars and a journal centering on human speech generation and recognition.

ENM offers a catalog of counting instruments and totalizers. Among their offerings is a \$14 six digit LCD counter that runs off two flashlight cells.

Vernier Software has a catalog of their science education hardware and software. It includes physics, biology, and chemistry products.

The free *Professional's Guide to Bar Coding* from Numeridex does a fairly good job on fundamentals. An unusual trade journal for this month is *A&E*, which is short for Awards and Engraving; you can find all sorts of oddball stuff there such as rubber-stamp supplies, photopolymers, pad printing presses, laser tools, and diffusion inks.

A reminder that my classic CMOS Cookbook is back in print and available from Butterworth-Heinemann. Auto-graphed copies, either by themselves or included in my bargain Lancaster Classics Library package, are available from my Synergetics Press as per my nearby ad. You'll find further tech support on my Guru's Lair web site, www.tinaja.com. My recent additions include new library pages on Acrobat and wavelets, plus files on caller ID, VCR-plus codes, and flutterwumper utilities and tutorials. As usual, most of the mentioned references appear in the Names & Numbers or the Aerogel Resources sidebars. Be sure to check those out before calling our tech helpline. 

AMERICAN HEART
ASSOCIATION
MEMORIALS & TRIBUTES



1-800-AHA-USA1

American Heart Association 

Making Better Holograms

WHILE SINGLE-BEAM HOLOGRAMS LIKE THE ONES WE COVERED LAST TIME ARE FASCINATING, AND MOST CERTAINLY DEMONSTRATE THE TECHNIQUES AND PRINCIPLES INVOLVED, THEY DO HAVE SOME SIGNIFICANT DRAWBACKS. FOR

example, control over both shadow detail and beam ratios is virtually nil. The way to get around those problems is to incorporate additional beams to provide the needed control. Even just adding one additional beam can provide significantly better results.

Setting Up a Dual-Beam Hologram

There are two basic methods you can use to create a dual-beam hologram. The best method is to use a second laser in the assembly. The advantage is that the intensity of the light source remains high, keeping exposures short. If a second laser is available and you do use this option, be sure that both tubes deliver the same output power.

The second method is to split the beam as we did when we set up our light show. The result is two beams, but each will have half the power of the original. This is the most common set up as it is more economical and eliminates the need to match two lasers.

Once you have selected the option you like, the rest of the assembly is straightforward. Figure 1 shows how to set up a dual-beam hologram using a single laser, while Fig. 2 shows how to set up two separate lasers to do the same task.

Simple Light Meters

If you use the dual-laser method, you will need a light meter to make sure that the outputs of the two lasers match

closely. Figure 3 shows three different versions of a simple light meter for this job. The one shown in Fig. 3A is a basic series circuit that incorporates a cadmium sulfide cell, a 1-mA analog meter, and a 100,000-ohm potentiometer that serves as a sensitivity control.

The circuit in Figure 3B is basically the same; however a closed-circuit jack (J1) has been added to accommodate a remote photocell. When the remote photocell is plugged in, the internal one is disconnected. This circuit also has output jacks that can be used for connecting an external meter if desired. In the circuit of Fig. 3C, additional gain for improved sensitivity is provided by a transistor amplifier.

WARNING!!!

This article deals with and involves subject matter and the use of materials and substances that may be hazardous to health and life. Do not attempt to implement or use the information contained herein unless you are experienced and skilled with respect to such subject matter, materials and substances. Neither the publisher nor the author make any representations as for the completeness or the accuracy of the information contained herein and disclaim any liability for damages or injuries, whether caused by or arising from the lack of completeness, inaccuracies of the information, misinterpretations of the directions, misapplication of the information or otherwise.

Making a Dual-Beam Hologram

For the remainder of this column we will discuss using the single-laser approach shown in Fig. 1. The first optical element the beam sees is the beam splitter. It is designed to split the beam in two, and aligned to pass one beam, which we call the reference beam,

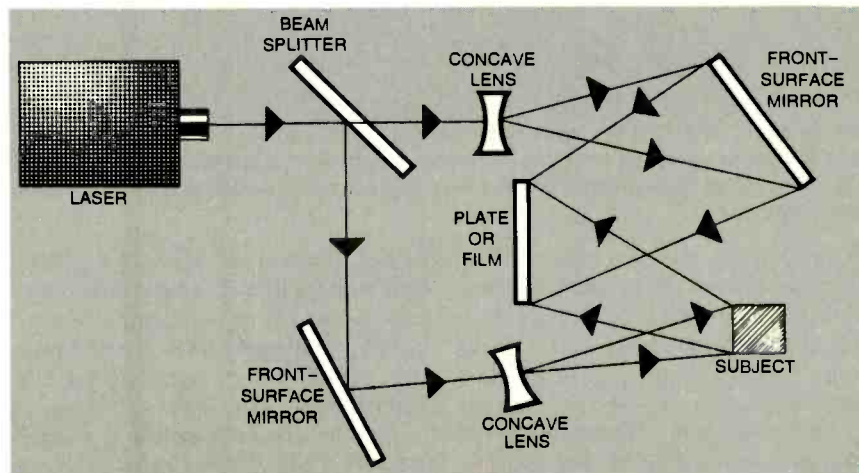

FIG. 1—DUAL-BEAM HOLOGRAMS can be created using a single laser if a setup like this one, which makes use of a beam splitter, is used.

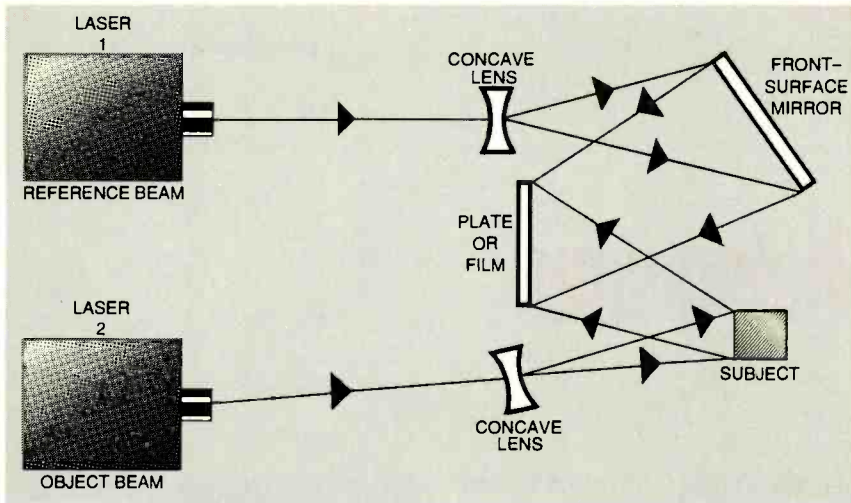

FIG. 2—BETTER RESULTS CAN BE ACHIEVED using two lasers in a set up like this one. The drawbacks are that the laser outputs must be matched and the increased cost.

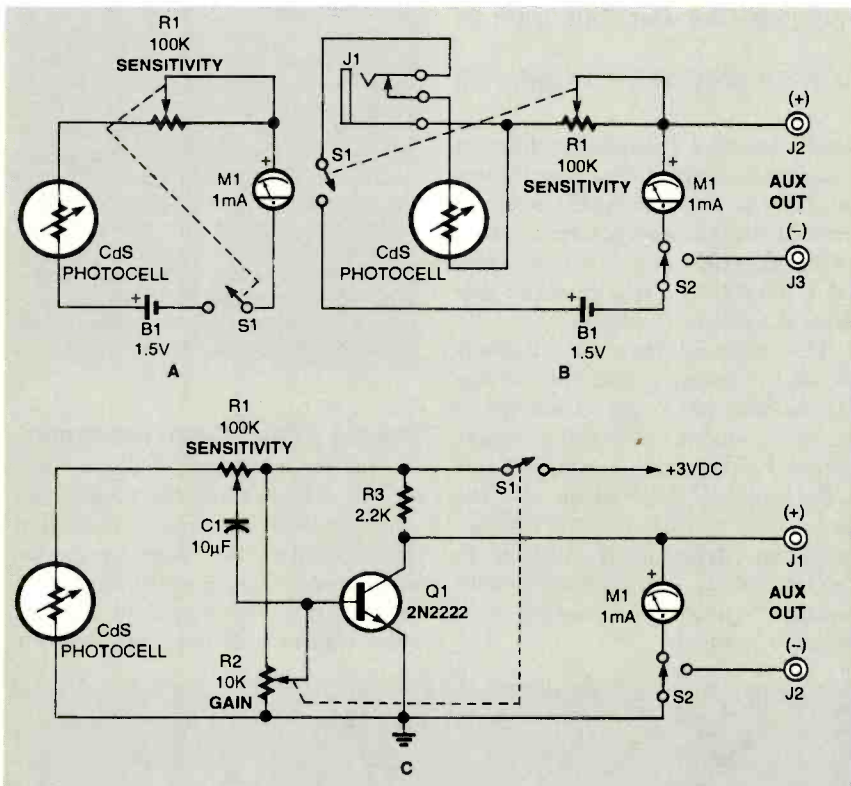

FIG. 3—HERE ARE THREE cadmium-sulfide light meters that you can use to balance the laser light when setting up for taking holograms. The basic circuit is shown in A, one with a provision for an external cell and meter in B, and one with an amplifier stage for greater sensitivity in C.

straight ahead, and send the second, which we call the object beam, out at a 90-degree angle. The object beam then reflects off a front-surface mirror. Both beams are fed through separate concave diverging lenses.

The reference beam continues through its lens and on to another front-surface mirror, which reflects back to the film holder. After the object beam passes through its concave lens, it strikes the

subject, bounces off of it, and reflects back onto the film. The interference patterns caused by the two beams converging on the photosensitive material provides the information needed to create a 3-D image.

One point that you must keep in mind is that the "path distance" of both beams has to be within about an inch of each other. Also, for best results you should minimize any spillover of light on the

subject, mirrors, or holder. Ideally, the beams should spread just enough to completely cover the area of the film holder. The beam spread is adjusted by moving the concave lens closer to or farther away from the light source until you have set the proper divergence.

Now you can position the subject for better control over shadowed areas, and with the help of neutral density filters, you can also adjust the beam ratios. With everything in place, darken the room, load the film, and make the shot. As before, start with exposure times of 3 to 5 minutes, as basically the same total amount of light is falling on the film (even though it has been split into two beams). However, once again, a little experimenting will be needed to find the best exposure times.

Thanks to the added control it provides, the quality of holograms made with dual beams will be far better than the ones made with a single beam. If you want even higher quality, use additional beam splitters and mirrors to create more object beams so you can more carefully adjust the lighting on the subject. Just remember to check the path distances of the two lasers and match the initial measurements.

These experiments lay the foundation for just about all types of holography. More complex assemblies can be arranged using spatial filters, overhead and collimating mirrors, and other optics, but those layouts require larger, more powerful lasers. If you want to go further, you could investigate using some of the 3-, 5-, or even 10-mW tubes available on the surplus market. The additional output will keep the exposure times within limits that are practical. However, please keep safety factors in mind when using lasers of this size and power. Not only is there an increased danger of retinal damage, but their power supplies deliver much higher voltages and currents.

Once the hologram has been shot, the exposed film or plate needs to be processed as soon as possible to insure the best results. All photographic emulsions degrade if not processed promptly after exposure, and these films are no different. Rather than getting into a highly technical explanation of these products, we'll just point out that while we are working with specialized films that are sensitive to the characteristics of laser light, the chemistry is not different from standard photo processing. The developer is a graphics type, with a part

A and a part B. Neither one should be mixed until it is ready to be used. Time/temperature tables are supplied with the chemicals. You will need a thermometer to determine the correct developing time. If you use a stop bath, both it and the fixer (hypo) are standard photographic solutions.

Since the exposure is made on either a plate or sheet film, tray processing is probably the best and easiest way to develop the holograms. Total darkness is necessary, and be sure to provide proper agitation (approximately every 30 seconds). After the film has been rinsed in running water for several minutes, run it through a squeegee or a wetting agent such as "Photo-Flo", to prevent water spots. Hang it up to dry in a warm, dust free environment, and your hologram will be complete.

At first glance, a finished hologram is hardly a sight to behold. It's going to look a lot like an unexposed negative with a frosted or matte finish. On very close examination, it is occasionally possible to detect a pattern, but for the most part it will look like a dismal failure. That happens because the hologram is being viewed under normal white light. The problem is that a hologram has to be viewed under light of the same wavelength as was used when it was exposed. In other words, the image is there, and visible, but is being washed out. However, when you view the hologram under the coherent illumination of a laser, the image comes alive in 3-D. As the hologram is turned, the subject turns and is visible from different angles. In ultra-quality exposures, the objects will seem solid and real.

Holography, much like laser research in general, has made tremendous strides since its conception. It is certain that in the years to come even more remarkable applications of this science will grace both the technical and commercial aspects of our lives. Give it a try, and enjoy the results.

That wraps things up for this month, and for "Laser Experiments," as this will be the final installment. For those interested in more, watch for a book that is scheduled to be published later this year that will contain the entire text of these columns, plus some additional material on other topics such as semiconductor lasers. It has been my pleasure to have written and presented this column, and I sincerely hope that you have found it educational and entertaining. **EN**

NEW LITERATURE

continued from page 21

step through every task. Novices as well as experienced Internet users will profit from its expert advice.

The book is divided into three sections. Part One shows you how to get connected and install Netscape Navigator, and takes you on a quick tour of a few Web sites. Part Two is a guided tour of Netscape and the World Wide Web. It explains the menu bar, the tool bar, and the directory buttons, along with some of the software's hidden features. The many hands-on sessions provided in Part Three show you how to use Netscape for telnet, ftp, gopher, and Usenet news; how to go beyond e-mail to find a wide array of multimedia files; and how to customize Netscape for your own needs and tastes.

The book offers 11 on-line learning sessions. Each session takes you through several different activities, offers helpful hints, warns you in advance when a step is particularly complicated, and is accompanied by two video tutorials, provided on the CD-ROM. The disk's software library helps you make the most of Netscape's access to multimedia material, with software like Adobe Acrobat and Quicktime for Windows.

ARRL Handbook CD Version 1.0

The American Radio Relay League
225 Main Street
Newington, CT 06111-1494
Tel: 860-594-0214
Fax: 860-594-0259
E-mail: tis@arrl.org
Web site: <http://www.arrl.org>
\$49.95



CIRCLE 343 ON FREE
INFORMATION CARD

For several generations past, all sorts of radio enthusiasts—hams and students, technicians and engineers—have turned to the *ARRL Handbook* for answers to basic and complex radio questions. Now the *Handbook* has entered the computer age. This disk contains the full text of the 1997 edition, complete with all of the drawings, tables, illustrations, and photographs that accompany

the hard copy. It adds sound clips to illustrate many of the modes, activities, and concepts discussed in the text.

The CD-ROM incorporates a powerful search engine to help users quickly locate topics of interest by entering key words or phrases. Bookmarks make it easy to return to often-used subjects, and zooming controls let the user reduce or enlarge the text and illustrations. Text and illustrations can be printed or pasted into other Windows applications. Also included on the CD-ROM is a subdirectory with all the utility software that is found on the print edition's companion disk.

JavaScript Developer's Resource

by Kamran Husain & Jason Levitt
Prentice-Hall PTR
One Lake Street
Upper Saddle River, NJ 07458
Fax: 201-236-7123
Web site: <http://www.prenhall.com>
\$44.95, including CD-ROM



CIRCLE 344 ON FREE
INFORMATION CARD

JavaScript is a full-fledged scripting environment that can help you achieve Java-like benefits without becoming an expert Java Programmer. This book and CD-ROM package, aimed at Web-site and Intranet developers, is a start-to-finish guide to writing JavaScript applications.

The book introduces readers to every aspect of client-side scripting. It presents all the basics—including functions, variables, operators, I/O, and the JavaScript Object Mode—as well as advanced techniques like forms and event handling. Coverage of the JavaScript development environment includes a discussion of the Navigator 3.0 browser. The book shows readers how to extend JavaScript's power with Java applets and plug-ins. It provides code samples, tips for optimizing scripts, and potential pitfalls to avoid.

All of the JavaScript examples presented in the book appear on the CD-ROM. The disk also contains Netscape plug-ins such as MacroMedia ShockWave (for PowerMac and Windows 95 and NT), Crescendo Plug-in (Mac and Windows 95 and NT), Adobe Acrobat

continued on page 70

Q & A

continued from page 9

that the input and output voltage can swing all the way to ground; most other op-amps won't work.

One PC, Two Keyboards

Q Can you show me a device that would allow me to connect two keyboards to the same computer at the same time? — R. S., Mountain Home AFB, IN

A What you ask isn't easy to do because communications between the PC and the keyboard is bi-directional. They use a two-wire serial bus similar to that of the analog-to-digital converter featured in this column in October 1996. It has pull-up resistors to +5V, and either the PC or the keyboard can pull it low to send a signal.

When the PC sends a message to the keyboard, such as "Turn on your Caps Lock Light," both keyboards will respond at the same time. To successfully disentangle their messages requires a microprocessor.

Multiplexers for attaching multiple keyboards to a PC are made by Vetra Systems Corporation (275J Marcus Blvd., Hauppauge, NY 11787, Tel: 516-434-3185) and are priced from \$215 and up. Vetra also makes circuits for interfacing switches and custom keypads to the PC keyboard port.

If you can live without Caps Lock, Num Lock, Scroll Lock, and some other advanced keyboard functions, the circuit in Fig. 4 might do the job for you. It lets both keyboards transmit to the CPU. Transmission in the other direction, as well as from keyboard to keyboard, is blocked by the diodes. Keyboard connector pin-outs are shown in Fig. 5. To learn more about how the keyboard works, see *The Undocumented PC*, by Frank van Gilluwe, published by Addison-Wesley.

Need TV Video From Computer

Q We want to use a computer to generate a display of weather information for transmission by TV. Interfacing the PC to the weather sensors isn't the problem; we have that worked out. What we need, however, is

a circuit I could build to convert the computer's video into standard TV signals? Could you help?— M. M., Corn, OK

A The problem, as you note, is that the video signals coming out of a VGA or super VGA card aren't compatible with American (NTSC) TV. They're carried on several wires instead of just one ("composite video"), and the scan rates are different.

Unfortunately, VGA-to-NTSC converter circuits are complex and beyond the scope of this column. The good news is that they are now standard items in larger computer stores. They're used by business people who give presentations using TV projectors. One popular model is the AITech Pocket Scan Converter; you can reach AITech at 1-800-487-0761 or on the Internet at <http://www.aitech.com>. Some other scan

HOW TO GET INFORMATION ABOUT ELECTRONICS

On the Internet: See our Web site at <http://www.gernsback.com> for information and files relating to our magazines (Electronics Now and Popular Electronics) and links to other useful sites.

To discuss electronics with your fellow enthusiasts, visit the newsgroups sci.electronics.repair, sci.electronics.components, sci.electronics.design, and rec.radio.amateur.homebrew. "For sale" messages are permitted only in rec.radio.swap and misc.industry.electronics.marketplace.

Many electronic component manufacturers have web pages; see the directory at <http://www.hitex.com/chipdir/>, or try addresses such as <http://www.ti.com> and <http://www.motorola.com> (substituting any company's name or abbreviation as appropriate). Many IC data sheets can be viewed online.

Books: Several good introductory electronics books are available at Radio Shack, including one on building power supplies.

An excellent general electronics textbook is *The Art of Electronics*, by Paul Horowitz and Winfield Hill, available from the publisher (Cambridge University Press, 1-800-872-7423) or on special order through any bookstore. Its 1125 pages are full of information on how to build working circuits, with a minimum of mathematics.

Also indispensable is *The ARRL Handbook for Radio Amateurs*, comprising 1000 pages of theory, radio circuits, and ready-to-build projects, available from the American Radio Relay League, Newington, CT 06111, and from ham-radio equipment dealers.

Copies of past articles: Copies of past articles in *Electronics Now* and *Popular Electronics* (post 1992 only) are available from our Claggk, Inc., Reprint Department, P.O. Box 4099, Farmingdale, NY 11735; Tel: 516-293-3751.

Electronics Now and many other magazines are indexed in the *Reader's Guide to*

Periodical Literature, available at your public library. Copies of articles in other magazines can be obtained through your public library's interlibrary loan service; expect to pay about 30 cents a page.

Service manuals: Manuals for radios, TVs, VCRs, audio equipment, and some computers are available from Howard W. Sams & Co., Indianapolis, IN 46214 (1-800-428-7267). The free Sams catalog also lists addresses of manufacturers and parts dealers. Even if an item isn't listed in the catalog, it pays to call Sams; they may have a schematic on file which they can copy for you.

Manuals for older test equipment and ham radio gear are available from Hi Manuals, PO Box 802, Council Bluffs, IA 51502, and Manuals Plus, Box 637, Spanaway, WA 98387.

Replacement semiconductors: Replacement transistors, ICs, and other semiconductors, marketed by Philips ECG, NTE, and Thomson (SK), are available through most parts dealers (including RadioShack on special order). The ECG, NTE, and SK lines contain a few hundred parts that substitute for many thousands of others; a directory (supplied as a large book and on diskette) tells you which one to use. NTE numbers usually match ECG; SK numbers are different.

Remember that the "2S" in a Japanese type number is usually omitted; a transistor marked D945 is actually a 2SD945.

Hamfests (swap meets) and local organizations: These can be located by writing to the American Radio Relay League (Newington, CT 06111; <http://www.arrl.org>). A hamfest is an excellent place to pick up used test equipment, older parts, and other items at bargain prices, as well as to meet your fellow electronics enthusiasts both amateur and professional.

converters might be available at low, surplus prices from Halted Specialties, 1-800-442-5833, or on the Internet at <http://www.halted.com>.

Digital Volume Control

Q This is a request for some information about how audio levels are controlled using pushbuttons. The signal I need to control is no more than 4-volts p-p and for a suitable volume control it would have to be attenuated at least 60 dB. — D. M. C., North York, Ont., Canada

A Write to National Semiconductor Corporation, Santa Clara, CA 95052-8090, and ask for the data sheet for the LM1972 78-dB audio attenuator chip, or download the information from their Web site at <http://www.national.com>. This is a 2-channel audio volume control that should meet your needs. The catch is that this chip requires more than just pushbuttons to control it—it requires a serial data stream from a microcontroller.

A digital volume control with a simple pushbutton interface would be handy. Does anybody out there know of one?

Giant Bargraphs Revisited

In August 1996, a reader asked how to build a giant LED-like bargraph display for use at the front of a lecture room. We suggested incandescent bulbs controlled by solid-state relays. Dr. Walter Lwowski of New Mexico State University wrote to tell us that he uses high-brightness (600-millicandela) red LEDs for the same purpose, and since they draw only 20 mA, they can be driven directly by the LM3914.

Writing to Q&A

Unfortunately, we've come to the end of our space for this time. As always, we welcome your questions. Write to: Q & A, **Electronics Now** magazine, 500 Bi-County Blvd., Farmingdale, NY 11735. The most interesting ones are answered in print, usually within 9 months. Please be sure to include plenty of background information (we'll shorten your letter for publication). If you are asking about a circuit, please include a complete diagram. Due to the volume of mail, we regret that we cannot give personal replies. **EN**

COMPUTER CONNECTIONS

continued from page 28

By contrast, the bottom has fallen out on the prices of 486 and low-end Pentium notebooks and subnotebooks. *Computer Shopper* is full of close-out sales on these types of devices; even local computer stores have some good bargains. And with those devices you can run a standard OS and choose among thousands of software packages. OK, a

LISTING 2

```
const
//PORT_BASE = $0378; // LPT1
PORT_BASE = $0278; // LPT2
PORT_DATA = PORT_BASE;
PORT_STATUS = PORT_BASE + 1;
PORT_CONTROL = PORT_BASE + 2;

{ — Port I/O routines — }
procedure PortDataOut (b : byte);
asm
  mov dx, PORT_DATA
  mov al, b
  out dx, al
end;

procedure PortControlOut (b : byte);
asm
  mov dx, PORT_CONTROL
  mov al, b
  out dx, al
end;

function PortStatusIn : byte;
asm
  mov dx, PORT_STATUS
  in al, dx
end;

function PortControlIn : byte;
asm
  mov dx, PORT_CONTROL
  in al, dx
end;
```

subnotebook won't fit in your shirt pocket. But it has a full-size keyboard and some kind of pointing device. And you can expand it using standard (medium-volume, medium-cost) peripherals (PCMCIA cards) for networking, modeming, and so on. I've seen \$800 machines that would be more than adequate for portable note-taking and schedule management. Typically they have mid-range 486s, 8 MB of RAM, 120-MB HD, and Windows 3.1.

That's all for now, until next time, you can e-mail me at jkh@acm.org. **EN**

AUDIO UPDATE

continued from page 58

things that a meter cannot. A wide range of oscilloscopes, both new and used, are readily available. Remember, we are testing audio frequencies, so we do not need a scope that has a wide bandwidth. One with even a 5-MHz bandwidth will do the necessary job with ease. I have designed an LED oscilloscope with a 10 × 10 matrix display that is very affordable and easy to build. The simplified schematic for it is shown in Fig. 3. Obviously, a 10 × 10 LED display does not provide the kind of resolution a standard CRT scope would, but it is adequate for the task, affordable, portable, and compact.

Distortion Analyzer

A distortion analyzer is another very useful instrument. It can measure the amount of total harmonic distortion plus noise in the audio device or system under test. There are three typical circuits used in these analyzers—Wien nulling network, parallel-T, and variable filters in notch mode. While all three types work well, if you chose to build the instrument I will describe, you will discover that it is a Wien nulling network type. I selected it because it has a simpler design and the components needed are readily available. Figure 3 shows its basic circuitry.

Wow-and-Flutter Meter

The last instrument in the series is our wow-and-flutter meter. If you will be working tape decks, that instrument is used to check, obviously enough, a deck's wow and flutter parameters. When we get to the installment that deals with building that instrument, we will go into great depth on how to use it. In the meantime, Fig. 4, illustrates the basic circuit.

Away We Go!

Now that we have laid the groundwork, we'll ask you to stand by for the next installments. Each will bring you the construction details needed to build the suite of test gear we've just described, as well as the test procedures you need to use these important audio test instruments to their full advantage. Fortunately, the wait won't be long as we'll get right to work next time we meet; Hope to see everyone again at that time! **EN**

NEW LITERATURE

continued from page 67

(for Windows, Mac, Sun SPARC, and HP-UX), and ToolVox Player (for Windows 95 and Mac).

Troubleshooting & Repairing Compact Disc Players: Third Edition

by Homer L. Davidson
TAB Electronics Technician Library
McGraw-Hill, Inc.
11 West 19th Street
New York, NY 10011
Tel: 212-337-5951
Fax: 212-337-4092
\$24.95

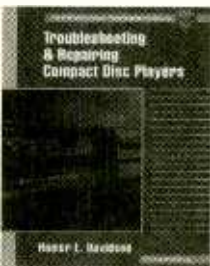

CIRCLE 345 ON FREE INFORMATION CARD

This comprehensive book on diagnosing and correcting problems with CD players contains a wealth of practical information. Written for practicing technicians as well as students and hobbyists, it covers current models of portable, home, and car CD players. Step-by-step instructions, helpful flowcharts, and clear text are supplemented by plenty of illustrations, schematics, and photographs.

The book begins with vital background information, examining the underlying principles of CD players in general. It then explains how to remove and replace defective laser heads and locate and replace defective slide, load, and disc motors. The book contains hands-on advice on using an oscilloscope to service signal circuits, fixing servo systems, and building an infrared tester. The third edition has been updated to include the newest models of compact disc players.

1997 Antennas & Accessories Catalog

Firestik Antenna Company
2614 East Adams Street
Phoenix, AZ 85034-1409
Tel: 602-273-7151
Fax: 602-273-1836

E-mail: firestik@primenet.com
Web site: <http://www.firestik.com>
Free



CIRCLE 346 ON FREE INFORMATION CARD

This 28-page, full-color catalog features antennas and accessories for CB, scanner, cordless phones, and amateur radio. Highlights include a wide variety of CB antennas, kits, and accessories for use on cars, trucks, RVs, motorcycles, ATVs, boats, and big rigs. The guide provides valuable tuning instructions that cover the set up and testing of antenna systems. It also lists the ten most common problems that create poor SWR.

The Essential Client/Server Survival Guide: Second Edition

by Robert Orfali, Dan Harkey & Jeri Edwards
John Wiley & Sons, Inc.
605 Third Avenue
New York, NY 10158-0012
Tel: 1-800-225-5945
Web site: <http://www.wiley.com>
\$32.95

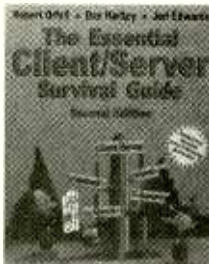

CIRCLE 347 ON FREE INFORMATION CARD

Completely revised and updated, this book takes readers on an entertaining, informative tour of the client/server world—complete with the endearing Martian guides from the first edition. The book makes detailed technical subjects fun and easy to learn with its unique brand of offbeat humor, trademark cartoons, and controversial soapboxes. New sections cover hot client/server topics such as Java objects, object Webs, and data warehousing.

Aimed at anyone who's associated with the computer industry, the book provides an overview of the client/server infrastructure and examines the client/server capabilities of Windows 95, OS/2 Warp, Windows NT, Unix, and NetWare. It explains base middleware, distributed security services, and peer-to-

peer communications. The book explores database server, groupware, TP, and distributed objects client/server models, and discusses how client/server relates to the Internet, Intranet, and the World Wide Web.

Assembly Language Master Class

Wrox Press Ltd.
2710 West Touhy
Chicago, IL 60045
Tel: 1-800-814-3461
Fax: 312-465-3559
E-mail: feedback@wrox.demon.co.uk
\$49.95, including disk

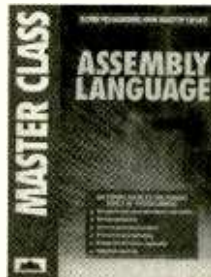

CIRCLE 348 ON FREE INFORMATION CARD

PC application developers need assembly language to work efficiently and to stay competitive. This book, written by a group of ten power-programming industry experts, gives programmers an edge in their real-world solutions.

For Intel chips up to and including the Pentium, the book contains chapters on everything from system programming through sound and SVGA, to virus protection and protected-mode programming. It includes many undocumented features and optimizations. The book covers disk management, memory management including XMS and DPML, 386/486 protected-mode programming and DOS extenders, compression techniques, code optimization, and essential graphic library utilities. It also explains how to program SVGA to maximum effect.

The disk includes a custom graphics library, a working anti-virus program, memory managers and interrogation programs, test and optimization programs, and all source code. **EN**

There's a life
to be saved right now.

Please give blood.

Call 1-800 GIVE LIFE



Electronic

SHOPPER

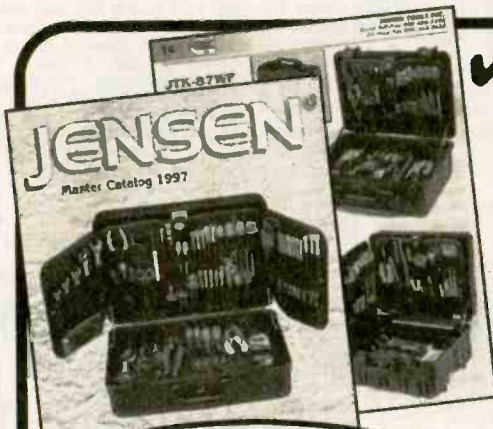

✓ - Check Your Jensen Benefits

- ✓ Tool Kits for Installing, Maintaining
Trouble-Shooting & Repairing PC/Computers
- ✓ Electronics Testing & Diagnosing Equipment
- ✓ Networking Accessories . . . and much more!
- ✓ Prompt Delivery of Your Order
- ✓ Courteous Customer Service at All Times
- ✓ Free Technical Support, Including FaxBack®
- ✓ Lifetime Guarantee on Jensen Brand Hand Tools

**FREE
CATALOG!**

Call Dept. 156
800-426-1194



JENSEN TOOLS

7815 S. 46th St., Phoenix, AZ 85044
Tel: 800-426-1194 or 602-968-6231
Fax: 800-366-9662 or 602-438-1690
<http://www.jensentools.com>

CIRCLE 282 ON FREE INFORMATION CARD

MICRO SIZE CCD VIDEO CAMERAS

MB-750U
Video Camera
\$99.95

MB-705UX
C-Mount Camera
with Lens Included;
8 or 12mm Lens



Micro Lipstick Cameras for Teleconferencing.

PANASONIC & SONY
Imaging Distributor

Polaris Industries

New Literature Available for All Models. Same Day Shipping from Stock!

1-800-752-3571

Visit Polaris Ind. Web Site at:
<http://www.polarisusa.com>



470 Armour Drive NE • Atlanta GA 30324 • Tech Info: 404-872-0722 • FAX 404-872-1038

SPECIAL PROJECTS



We design/build/modify/repair/consult on any device / system / process / project electronic / computer / mechanical / optical (eg: phone/auto/security/Radionic/lab/energy/HV/EM/RF/radar/ultrasonic/IR/UV/commo) for business and personal/invention needs. Describe & include nonrefundable \$30 pre-engineering fee. Time & cost estimates sent in 7-10 days. Confidentiality guaranteed!

OFF-THE-SHELF HARDWARE

Van Eck Systems ★ Data Card Reader/Writers ★ RF/EM/μWave/Radar/Ultrasonic/IR/Light/Sound Detectors/Xmitters/Jammers/Blasters ★ Security/Surveillance ★ EM Weapon Countermeasures ★ Neurophone/Rife/Crystal Radionics ★ Bug & Tap Detectors/Blasters ★ Lineman's Handsets ★ Phone Color Boxes ★ Voice Disguisers ★ ESS Infinity Devices ★ DTMF Decoders ★ Child Finder ★ Panic Button ★ Slot Machine Masters ★ Subliminal Mixer/Amps (Ultrasonic/Infrasonic) ★ TENS ★ Hearing Assistors ★ Electronic Dowzers ★ Shriek Modules ★ Ghost Detectors ★ Vortex Generators ★ Alien Brainblasters ★ 6th Sense Communicators ★ More! Order Catalog Today!!

AUTOMATIC TELLER MACHINES



ATM crimes, abuses, vulnerabilities and defeats exposed! 100+ methods detailed, include: Physical, Reg. E, cipher, PIN compromise, card counterfeiting, magnetic stripe, false front, TEMPEST, Van Eck, tapping, spoofing, inside job, super-cool, vibration, pulse, high voltage-others. Case histories, law, countermeasures, detailed security checklist, labeled internal photos, figures. ATMs contain up to \$250,000 in cash!

PAGER (BEEPER) MANUAL



Describes in detail how Pagers work, different types and uses, frequencies, advantages over and uses with cellphones, and tips and tricks. How Pagers are hacked and countermeasures. Includes plans for a Personal Pocket Paging System (xmitter and receiver).

HACKING FAX MACHINES



Describes in detail how Fax Machines are hacked and countermeasures. Includes G3 Fax protocols, comomo parameters, compression algorithms, Class 1 & Class 2 commands, Spy Fax Switcher, Fax Servers, FODs/FOCs, and Makeup/Terminating Codes. And insights into designing Fax interception devices and modifying existing Faxes into Stealth Faxes. Eye-popping and invaluable!

PBX HACKING



PBXs are hacked to the tune of about \$8 Billion/yr! "PBX Hacking" exposes all issues relating to PBX hacking, including countermeasures. This manual was featured in Forbes Magazine! Shocking!

VOICE MAIL HACKING



Exposes how Voice Mail Box systems are used and specific ways they are hacked. Includes ASPEN, MESSAGE CENTER, BIX, GENESIS, RSVP, CENTAGRAM, EZ, AUDIX, SYDNEY, PHONE MAIL, CINDY, SPERRY LINK, etc. A must for all users, hackers, and security personell!

10% OFF
Orders Over
\$100!!

TOP SECRET

NEW
LOWER
PRICES!

CONSUMERTRONICS

P.O. Box 23097 ABQ, NM 87192

ORDER TODAY! 505-237-2073

Fax: 505-237-2073, then "#11 #11"

Web Adventure: www.tsc-global.com

Established in 1971. Featured on CBS "60 Minutes," Forbes, New York Times. Add \$5 total S/H (US, Canada). Sold for educational purposes only. Postal M.O. is fastest. VISA, MC OK. COD (\$49-\$999), add \$7.

STOPPING POWER METERS



As reported on "60 MINUTES"! How devices can slow down (even stop) watt-hour meters - while loads draw full power! Device plugs into one outlet and normal loads into other outlets. Describes meter creep, overload droop, etc. Plans!

THE I.G. MANUAL: External magnetic ways (applied to meter) to slow down and stop power meters while drawing full loads. Plans. \$25.

KW-HR METERS: How watt-hour meters work, calibration, error modes (many), ANSI Standards, etc. Demand and Polyphase Meters. Experimental results to slow and stop meters by others. A real eye-opener! \$25.

Special! All 3 (above), Only \$59!

BEYOND PHONE COLOR BOXES



Dozens of PCB's described - many circuits. Plus Call Forwarding, Conferencing, Phreak History, Glossary, Diverters, Extenders, Loops, REMOBS, Bridging Heads & Cans, Optocom, 3rd Party and many other non-box methods - more! \$29.

MIND CONTROL



Fear increases over EM and ultrasonic mind control technologies especially implants! Many more lies published than facts. Secret agents are often used for reporting back to covert organizations. Learn shocking truth about this bizarre phenomena! \$29.

HACKING ANSWERING MACHINES



All the known ways answering machines are hacked to listen to and erase messages, and to convert them into mini-VMBs. Plus countermeasures - protect yourself from hackers/thieves! \$19.

PHREAKING CALLER ID & ANI



Details on how they work and dozens of effective ways of defeating Caller ID, ANI, *69, *57, Call Blocking, *67 etc. Also describes Caller ID, Orange, Beige, Cheese & CF Boxes, ESS, SS7, E-911, various Class services, CN/A, Non Pub DA, CAMA, DNR, 800-ECR, Diverters, LD Extenders, Centrex - much more! \$19.

CELLULAR AND CORDLESS MODS

The ultimate cellular modification guide! See our Catalog for our infamous cellphone mod guide - very detailed, comprehensive, covers most makes - 10 times more info than any competitors' manual!

THE HACKER FILES



Compilation of 100s of the best eye-popping articles written by top hackers/phreakers. ASCII text. Covers every major topic in hackerdom! On 3 HD PC Disks! \$39.

UNDER ATTACK!



Electromagnetic weapon attacks cause cancer, birth defects, and profound psychological and neurological disorders! This manual includes actual cases of EM attacks (we investigated)! Includes how to tell if you are under an EM attack, and specific countermeasures. Much more! Shocking! \$19.

BY AN ORDER OF THE MAGNITUDE



The most comprehensive, hard-hitting, hi-tech survival book ever written! Topics include electronic, computer, comomo, chemistry, weaponry, cryptography, energy, concealment, revenge, alarm, disguise & ID change. Designs, tactics & strategies to survive an increasingly dangerous and brutal world. Field-expedient use of technology in various threat and conflict environments and scenarios. \$49.

THE ULTIMATE SUCCESS MANUAL



How to lie, cheat, steal, influence, and intimidate your way to success! Underpaid? Overworked? Harassed? Manipulated? Forget job performance. This manual outlines what it really takes to make it to the top in today's corporate BS world! \$19.

INTERNET CONS & SCAMS



Net cons and related frauds now rake in \$2+Billion annually! Most are done with little fear of prosecution. Detailed, + countermeasures.

INTERNET TRACKING & TRACING



The Net is infected with spammers, stalkers, scammers, infectors, and other wrongdoers who hide behind its anonymity. Learn how to trace them down in this comprehensive, eye-popping manual!

COMPUTER PHREAKING



Describes in detail how computers penetrate each other, and how VIRUSES, TROJAN HORSES, WORMS, etc are implemented. Dozens of computer crime and abuse methods and countermeasures. Includes disk filled with hacker text files and utilities, and the legendary FLUSHOT+ protection system. Internet advice, password defeats, glossary - much more! Manual + PC Disk!

BEYOND VAN ECK PHREAKING



Eavesdropping on TV and computer video signals using an ordinary TV described in detail. Includes security industry reports. Range up to 1 KM. Plans include both the Consumertronics and the original Top Secret Van Eck designs!

CREDIT CARD SCAMS



Completely describes every known means of credit card fraud and scams, + countermeasures. Protect yourself!

OTHER EXCITING TITLES!

CONS & SCAMS \$29

Most comprehensive manual on C&S available! Details 100s, their many variations, and countermeasures!

STEALTH TECHNOLOGY \$29

Every known police radar error - stealth method and material used to minimize radar and laser reflections - tactic and strategy to fight speeding tickets!

THE PLACAK REPORT \$29

How to read and decrypt the magnetic flux-reversal on popular credit and debit card magnetic stripes. How to determine the decrypted PIN, PAN, bank number, dates, number of uses remaining. No hardware needed!

HIGH VOLTAGE DEVICES \$29

Many HV device plans: Stun Gun, Taser, Prod, Cane, Flasher, Blaster, Zapper, Radar Jammer, Jacob's Ladder, Fence Charger, Geiger Counter, Fish Stunner, much more!

RADIONICS MANUAL \$29

Exciting electromagnetic therapeutic, diagnostic devices (mostly experimental). Descriptions, plans, availability.

ROCKET'S RED GLARE \$29

The most definite and comprehensive source on solid-propellant survival and amateur rocketry! Many plans!

FREE! \$14

How you can get FREE money, jobs, land, housing, meals, medical care, equipment, merchandise, much more!

POLYGRAPH DEFEATS \$19

How anyone can tell "the truth" to a "lie detector". Many proven methods to beat the test, and what to avoid.

SHOCKING!



ALL-NEW TOP SECRET CATALOG. FEATURES 200+ SURVIVAL PRODUCTS! WILL BLOW YOUR MIND! MAIL \$3, OR \$1 WITH ORDER!
ORDER TODAY!!

ALL ELECTRONICS

C O R P O R A T I O N

QUALITY PARTS

FAST SHIPPING

DISCOUNT PRICING

CALL, WRITE, FAX
or E-MAIL For A
Free 96 Page
CATALOG.
outside the U.S.A.
add \$2.00 postage.

Low Low Price!
25' BNC-BNC CABLE



25 foot RG58-A/U, 50 ohm co-ax cable with male BNC connectors molded with strain reliefs on both ends. Ideal for studio, lab or communications use. Inquire for quantity pricing.

\$4.75
each

CAT# CBL-25
10 for \$45.00

6KV TRANSFORMER

Primary:
110/220 Vac , 18.6
Ohms DC resistance.
Secondary:
6,000 Vac @ 0.01
Amps, 17.89K Ohms
DC resistance. Ideal for ozone
generators, bug zappers and other
high-voltage applications.
4.7" X 2.6" X 3.43" high.
Plastic mounting feet
with holes on 4.5" X 2.25"
centers. 9" long leads.

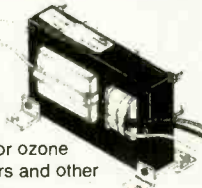

CAT# HVTX-4
\$20.00
each

**NOTEBOOK COMPUTER
CARRYING CASE**

Great looking, padded
carrying case, suit-
able for most
notebook
computers
or similar
equipment.
Black
leatherette exteri-
or with separate
zippered compartment
for papers or accessories.
Detachable nylon web shoulder strap. Interior
space is 13.5" X 9" X 2.5"

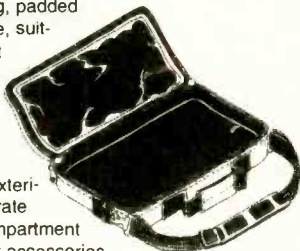

CAT # CSE-12
\$9.75
each

**470 UF, 450 VOLT
SNAP-IN CAPACITOR**

Nichicon LGQ2W471MHSC
1.375" diameter x 2" high.
0.4" lead spacing.

CAT#
EC-4745

\$4.50
each

10 for \$40.00

**THE INSULTINATOR
A Programmable
Electronic
Insult Machine**

"You're A Totally Freaky
Wacky Bonehead!"

Hand-held voice synthesizer plays
a variety of insults which can be altered by
selecting various programming buttons.
Thousands of possible insults. Even though no
profanity is used, a major nationwide retailer
rejected these as being too insulting for their cus-
tomers. Wild green and black case with belt or
pocket clip. Includes 3 AA batteries. Attractive
display package.



\$4.95
each

CAT# INS-5
24 for \$4.50 each

**AUTOMOBILE VOLTAGE
CONVERTER**

Run audio, communications
and other battery
operated
devices
from your
car
cigarette
lighter.
Regulated DC-DC
converter supplies
selectable voltages from 1.5 Vdc to 12 Vdc
at up to 800 milliamps. Adjustable polarity.
Includes six different adapter plugs that fit
most equipment.

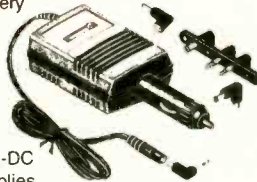

CAT # APC-800
\$4.00
each

**410 UF, 300 VOLT
PHOTOFLASH
CAPACITOR**



Rubycon # 1A2304A
0.7" dia. X 1.7" long. Right angle PC
or solderleads on 0.25" centers.

CAT# PPC-410

\$2.00
each

10 for \$18.50
200 for \$320.00

**AUTOMOTIVE POWER
CORD**



3 foot wire. Cigarette lighter plug
to 2.1mm co-ax plug, center positive
polarity.

CAT# CLP-33

\$1.50
each

10 for \$12.50
100 for \$100.00

6-12 Vdc MOTOR

Mabuchi # RS-375S-16115
1.08" dia. x 1.75" long.
0.9" dia. shaft is 0.5" long.
Solder terminals.



CAT#
DCM-80 **\$1.75**
each

**"HI-8" VIDEO CASSETTE
(USED)**

SONY Hi-8
Top quality, metal
particle 120 minute
video cassettes. Used
for a short time, then
bulk-erased. Each cassette
has its own plastic storage
box. Satisfaction
Guaranteed.



\$3.00
each

CAT # VCU-8

10 for \$28.00 • 100 for \$250.00

ORDER TOLL FREE

1-800-826-5432

MAIL ORDERS TO:
ALL ELECTRONICS CORP.
P.O. BOX 567
VAN NUYS, CA 91408-0567

FAX (818) 781-2653 • INFO (818) 904-0524
INTERNET <http://www.allcorp.com/>
E-MAIL allcorp@allcorp.com

NO MINIMUM ORDER • All Orders Can Be Charged to Visa, Mastercard, American Express or Discover • Checks and Money Orders Accepted by Mail • Orders
Delivered in the State of California must include California State Sales Tax • NO C.O.D. • Shipping and Handling \$5.00 for the 48 Continental United States - ALL
OTHERS including Alaska, Hawaii, P.R. and Canada Must Pay Full Shipping • Quantities Limited • Prices Subject to change without notice.

MANUFACTURERS - We Purchase EXCESS INVENTORIES... Call, Write, E-MAIL or Fax YOUR LIST.



WE HAVE IT ALL! Surveillance

Infinity Transmitters
FM Wireless Transmitter Kits
Vehicle Tracking Systems
Bug Detectors • Caller I.D.
Telephone Register with Printer
Long-play Recorders
Wired Mikes • Shotgun Mikes
Telephone Recording Adapters
Alcohol Testers • Drug Testers
Telephone Scramblers
Hidden Video Cameras
Telephone Tap Detectors
MUCH, MUCH, MUCH MORE.

Our 27th Year!

Small catalog FREE. Larger catalog send \$5.
Mail Order only. Visa, MasterCard and
C.O.D. accepted for equipment only.
Inquire for dealers' prices.

A.M.C. SALES, INC.

193 Vaquero Dr. • Boulder, CO 80303
Mon.-Fri. 8 a.m.-5 p.m. Mtn. Time
800-926-2488

(303) 499-5405 • Fax (303) 494-4924

Internet: <http://www.siteleader.com/>

catalogdepot/AMCSC-home.html

E-mail: amc-sales@siteleader.com

ABC ELECTRONICS 315 7TH AVE N. MPLS. MN. 55401
(612)332-2378 FAX (612)332-8481 30 DAY WARRANTY

WE BUY TEST EQUIPMENT AND COMPONENTS.

TEK 7A13 DIFFERENTIAL COMPARATOR	\$150.00	TEK 7B15 1 GHZ DELAYING TIME BASE	\$250.00
TEK 7A16P PROG.200MHZ VERT AMPLIFIER	\$75.00	TEK 7B50A 150 MHZ TIME BASE	\$75.00
TEK 7A17 150 MHZ SINGLE TRACE AMPLIFIER	\$50.00	TEK 7B52 DUAL TIME BASE	\$75.00
TEK 7A18 75 MHZ DUAL TRACE AMPLIFIER	\$50.00	TEK 7B53 100 MHZ DUAL TIME BASE	\$75.00
TEK 7A19 600 MHZ SINGLE TRACE AMPLIFIER	\$150.00	TEK 7B70 200 MHZ TIME BASE	\$75.00
TEK 7A22 DIFFERENTIAL AMPLIFIER	\$200.00	TEK 7B71 DELAYING TIME BASE	\$75.00
TEK 7A24 400 MHZ DUAL TRACE AMPLIFIER	\$200.00	TEK 7B80 400 MHZ DELAYED TIME BASE	\$100.00
TEK 7A26 200 MHZ DUAL TRACE AMPLIFIER	\$75.00	TEK 7B85 400 MHZ DELAYING TIME BASE	\$125.00
TEK 7D11 DIGITAL DELAY UNIT	\$50.00	TEK 7B90P PROGRAMABLE TIME BASE	\$200.00
TEK 7D12 A/D CONVERTER MAINFRAME	\$50.00	TEK 7B92A 500 MHZ DELAYING TIME BASE	\$125.00
TEK 7D13 DIGITAL MULTIMETER	\$50.00	TEK AM502 DIFFERENTIAL AMPLIFIER	\$75.00
TEK 7M11 DUAL 50 OHM DELAY LINE	\$100.00	TEK MX5010 MULTIFUNC.INTERFACE EXTEN.	\$200.00
TEK 7M13	\$50.00	TEK 7834 400 MHZ STORAGE MAIN FRAME	\$400.00
TEK 7S11 SAMPLING PLUG IN	\$200.00	TEK 7844 400 MHZ MAIN FRAME	\$400.00
TEK 7S12 GENERAL PURPOSE SAMPLER	\$350.00	TEK 7854 400 MHZ DIGITAL STORAGE FRAME	\$500.00
TEK 7S14 1 GHZ SAMPLING PLUG IN	\$350.00	TEK 7904 500 MHZ MAIN FRAME	\$250.00
TEK 453 50MHZ OSCILLOSCOPE	\$200.00	TEK 7104 1GHZ FRAME WITH-	\$2750.00
TEK 485 350 MHZ PORTABLE SCOPE	\$600.00	(7A29,7A29,7B10,7B15)	
KEITHLEY 480 PICOAMMETER	\$300.00	GENRAD 1657 RLC BRIDGE	\$750.00
TEK 608 MONITOR	\$650.00	TEK 577 DI/177 CURVE TRACER	\$1500.00
TEK DAS9100 WITH PROBES	\$750.00	TEK 7D20 PROGRAMABLE DIGITIZER	\$500.00
KIKUSUI 5020 20 MHZ OSCILLOSCOPE	\$180.00	TEK 465 100 MHZ OSCILLOSCOPE	\$400.00
PHILLIPS PM3212 25 MHZ OSCILLOSCOPE	\$200.00	TEK 465B 100 MHZ OSCILLOSCOPE	\$450.00
TEK 422 15 MHZ OSCILLOSCOPE	\$150.00	TEK 2335 100 MHZ OSCILLOSCOPE	\$1200.00
TEK 455 50 MHZ OSCILLOSCOPE	\$250.00	TEK 834 DATA COMMUNICATION TESTER	\$130.00
HP 6428B 0-20V/0-45A POWERSUPPLY	\$400.00	HP 5359A TIME SYNTHESIZER	\$1000.00
BRADLEY 132 SCOPE CALIBRATER	\$700.00	HP 6033A 0-20V/0-30A POWERSUPPLY	\$1200.00

BROADCAST TRANSMITTER

The FMS2 studio quality transmitter is FULLY crystal controlled and programmable to any FM broadcast frequency.

Unit features: ALC, 2:1 compressor, audio buffer / amplifier, pre-emphasis, roll off filter, stereo generator, digital PLL tuning, 75 MHz-125MHz bandwidth, 500mW power output and a special introductory price of only \$295.00 US

SCHEMATICS FOR UNIT \$27 CATALOG 800-504-1178
FAX POLL (800) 416-243-1067 TEK LINE 416-243-2260



CABLE TV CONVERTERS

Equipment & Accessories
Wholesalers Welcome

Call C&D ELECTRONICS
1-888-615-5757 M-F 10a-6p

FREEDOM-EARN ADDITIONAL INCOME EVERY WEEKEND BY INSTALLING MINI-SATELLITE DISH SYSTEMS- YOU OWE IT TO YOURSELF TO LEARN ABOUT THIS EXPLODING CONSUMER ELECTRONICS FIELD - DON'T DELAY CALL FLEX TODAY

USE YOUR KNOWLEDGE TO EARN REAL MONEY, RIGHT NOW!



Let's face it, you have the electronics background and maybe you're good at repairing consumer electronics, but you just can't seem to put the two together to make any **REAL money**. Now, with the **Video Guide to Basic and Advanced Mini-Satellite Installation**, you can use your skills to start earning hundreds of extra dollars every weekend by installing Digital Broadcast Satellite systems. This tape takes you through a basic single receiver installation to a more advanced **and more profitable** multiple receiver installation. This video will provide you with the "additional" hands-on knowledge required to make **REAL MONEY, RIGHT NOW!** In fact, not since the advent and marketing of the VCR has there been a more lucrative or faster growing segment of consumer electronics! In just a few weekends you could literally earn a thousand extra dollars to put in your pocket by performing 1 or 2 installations every weekend. Typical installations last only a few hours and could net you **\$150 or more!** Isn't it time you started making money from what you know? Call today to reserve your copy of the **Video Guide to Basic and Advanced Mini-Satellite Installation (VHS)**



\$29.95

VISA COD



Add \$4 for S&H
(COD add \$8.75)

1.800.307.7737
Flex Electronics

Prices and Specifications are subject to change without notice or obligation
Michigan Residents Add 6% Sales Tax

zisca@zisca.com

Sorry, return of tapes is limited to exchange only

CIRCLE 335 ON FREE INFORMATION CARD

**FREE CATALOG
CALL TOLL FREE
1-800-338-0531**

E-Mail: xpress@parts-express.com



**Parts
Express**

**UNBELIEVABLE
VALUE!**

X-10 POWERHOUSE

Check our catalog for a full line of X-10 Home Security and Home Automation products.



Weller WLC100 Soldering Station

The Weller WLC100 solder station is ideal for the professional, serious hobbyist, or kit builder who demands higher performance than usual of a standard iron, but without the high cost of an industrial unit. Power is adjustable from 5 to 40 watts. Includes 40 watt pencil iron. UL approved. Net weight: 1-3/4 lbs.



**SUPER
VALUE**

#EN-372-120 **\$39⁹⁵** EACH

**"The Sound Bridge" FM Stereo
Wireless Transmitter**

The Sound Bridge is a mini FM wireless transmitter that can be used to broadcast stereo sound from any audio source like portable CD players, TVs, electronic games, CD-ROM, even computer soundcards, to your home stereo receiver! Adjustable from 89 to 95.5 MHz.



**HOT
NEW
ITEM!**

#EN-249-220 **\$14⁹⁵** EACH

**3 Way Indoor/Outdoor
Speaker System**

These are the best sounding little speakers you can find at anywhere near this price! Perfect for rear channel use in a home theatre system or for outdoor use. Features 4" polypropylene woofer, 2" polycone midrange, 3/4" dome tweeter housed in a weatherized polystyrene enclosure. Frequency response: 90-20,000 Hz. Impedance: 4 ohms. Power handling: 30 watts RMS/60 watts max. Mounting brackets included. 7-1/4" H x 4-5/8" W x 4-3/8" D. Net weight: 6 lbs.



Compare To Special
#EN-319-020 (Black) **\$45⁰⁰** PAIR
#EN-319-025 (White) **\$29⁹⁵** PAIR

Home Theatre In-Floor Subwoofer

To fully appreciate the potential of movie soundtracks, a dual voice coil subwoofer is a must! Many film special effects are extremely demanding in the low frequency range and require a subwoofer that can duplicate explosions, earthquakes, even the footsteps of Tyrannosaurus Rex! This subwoofer fits the bill by featuring a 10" dual voice coil woofer for true stereo operation and high pass filters for your main speakers. The most unique feature of this subwoofer is the fact that it is designed to be mounted in between the floor joists in new and existing home constructions. Simply mount the in-floor sub to the joists and mount a heat register grill above opening in subwoofer front enclosure. The subwoofer is now totally out of view and ready to rumble! Includes detailed installation manual.



Specifications: 10" dual voice coil treated paper cone woofer with poly foam surround ♦ Frequency response: 30-100 Hz ♦ Nominal impedance: 8 ohms per coil ♦ Power handling: 100 watts RMS channel/140 watts max ♦ SPL: 89 dB 1W/1m ♦ Dimensions: 27" D x 14-5/8" W x 9" H ♦ Net weight: 29 lbs.

#EN-300-445 **\$139⁹⁵** EACH

Peak Instrument Co.

"The Woofer Tester"

Peak Instrument Co. proudly introduces "The Woofer Tester". Just ask any loudspeaker engineer, and they will tell that the only way to design enclosures of the correct size and tuning is to measure the Thiele-Small parameters for the actual drivers to be used. The reason? Manufacturers published specs can be off by as much as 50%! But until now, measuring the parameters yourself required expensive test equipment and tedious calculations, or super expensive measurement systems (\$1,200 to \$20,000). The Woofer Tester changes all that.



**QUICKLY AND ACCURATELY
MEASURES: F_s
Q_{ms}, Q_{es}, Q_{ts},
BL, SPL @ 1W/1m,
Mmd, C_m and R_m
IN MINUTES.**

30 DAY
MONEY BACK
GUARANTEE

1 YEAR WARRANTY ♦ SAME DAY SHIPPING

Finally, a cost effective, yet extremely accurate way to derive Thiele-Small parameters, in only minutes! The Woofer Tester is a combination hardware and software system that will run on any IBM compatible computer that has EGA or better graphics capability and an RS232 serial port. The Woofer Tester will generate the following parameters. Raw driver data: F_s, Q_{ms}, Q_{es}, Q_{ts}, V_{as}, BL, SPL @ 1W/1m, Mmd, C_m, and R_m. Sealed box data: F_{sb} and system Q. Vented box data: F_{sb}, ha, alpha, and Q loss. The Woofer Tester system includes hardware, test leads, serial cable, AC wall adaptor, detailed instructions, and software.

#EN-390-800 **\$249⁰⁰** EACH

5 Foot Stereo RCA Patch Cord

High quality, Japanese made patch cord features color coded RCA plugs on each end for easy polarity identification. Molded strain reliefs for extra long life and durability. Limited availability.



Part #	Description	Price (1-9)	Price (10-UP)
EN-189-070	Red/white plugs	\$1.20	\$0.95
EN-189-072	Yellow/black plugs	1.20	.95

Copper Clad PC Board

Now's the perfect time to start building your own PC boards! A factory buyout enables us to bring you this premium quality copper clad PC boards at unheard of low prices. Each board is coated with .0014" copper and is at least .060" thick. Limited availability.



Part #	Description	Price (1-9)	Price (10-UP)
EN-055-204	6" x 18" single sided	\$1.50	\$1.35
EN-055-206	6" x 21" single sided	1.75	1.55
EN-055-222	8" x 24" single sided	2.65	2.40
EN-055-252	6" x 18" double sided	2.25	2.00

**Speaker
Surround
Repair Kits**



- ♦ Do it yourself
- ♦ Save Money
- ♦ Complete instructions
- ♦ Wide variety of sizes and styles
- ♦ Hard to find Advent Woofer and Red Foam kits available

**CALL NOW FOR
SIZES AND MORE
INFORMATION**

900 MHz Wireless Speaker System

- ♦ 900 MHz technology sends signal up to 180 ft., through walls, floors and ceilings.
- ♦ Ideal for use as rear surround speakers or for adding wireless sound to every room in the house!
- ♦ Full range, bass reflex design with built-in high power, low distortion amplifier.
- ♦ Weather resistant cabinet for outdoor use.
- ♦ Selectable battery (six C size for each speaker) or AC operation, adaptor included. Built-in recharging circuitry for ni-cad batteries.
- ♦ System includes: 900 MHz transmitter, wireless speaker pair, AC adaptors, and all cables necessary to hook up system.
- ♦ Limited availability. ♦ Net weight 9 lbs.
- ♦ Frequency response: 20-18KHz.



#EN-319-030 **\$169⁹⁵** EACH



♦30 day money back guarantee ♦\$20.00 minimum order ♦We accept MasterCard, Visa, Discover, and company C.O.D. orders ♦24 hour shipping ♦Shipping charge = UPS chart rate + \$1.90 (\$5.00 minimum charge) ♦Hours 8:00 am - 8:00 pm ET, Monday - Friday ♦9:00 am - 5:00 pm Saturday. Mail order customers, please call for shipping estimate on orders exceeding 5 lbs. ♦Foreign destination customers please send \$5.00 U.S. funds for catalog. ♦Quantity pricing available.

1-800-338-0531

340 E. First St., Dayton, OH 45402-1257
Phone: 937-222-0173 ♦ Fax: 937-222-4644

CIRCLE 262 ON FREE INFORMATION CARD

CAPACITORS

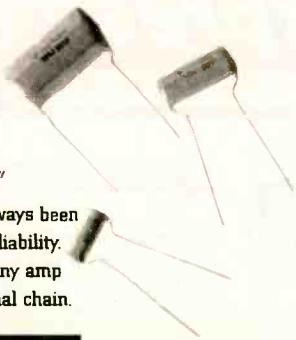

SPRAGUE "ORANGE DROPS"

Sprague polypropylene capacitors have always been famous for their great performance and reliability. Significantly improve the performance of any amp by upgrading to "Orange Drops" in the signal chain.

	1	10	25	50+
.001UF/600V	.45	.36	.32	.29
.0015UF/600V	.46	.36	.32	.29
.0022UF/600V	.47	.37	.33	.30
.0033UF/600V	.48	.37	.34	.30
.0047UF/600V	.49	.38	.34	.31
.01UF/600V	.50	.45	.40	.35
.015UF/600V	.65	.50	.42	.38
.022UF/600V	.68	.55	.46	.39
.047UF/600V	.80	.65	.59	.52
.068UF/600V	.95	.80	.74	.69
.1UF/600V	1.05	.92	.83	.74
.15UF/600V	1.40	1.25	1.05	.95
.22UF/600V	1.90	1.55	1.35	1.24
.47UF/400V	1.85	1.50	1.30	1.20



XICON CAPACITORS

Metalized Polypropylene. Made in JAPAN. A very high quality cost effective range of coupling capacitors. Great sound, small size.

	1	10	25	50+
.001UF/630V	\$.30	.24	.20	.17
.0022UF/630V	.30	.24	.20	.17
.0047UF/630V	.30	.24	.20	.17
.01UF/630V	.30	.24	.20	.17
.022UF/630V	.35	.26	.22	.19
.047UF/630V	.42	.36	.30	.26
.1UF/630V	.46	.40	.34	.30
.22UF/630V	.63	.56	.45	.40
.47UF/630V	1.20	1.00	.88	.79

TRANSOXM - SCREEN GRID RESISTORS

	10	25	50	100+
470 OHM / 1 WATT	\$.10	.08	.07	.06
1K OHM / 5 WATT	.32	.25	.22	.19



SPRAGUE "ATOM" ELECTROLYTICS

These electrolytics have been the standard in most vintage amps...and there's a good reason!

	1	10	25	50+
8UF/450V	\$2.25	1.95	1.85	1.68
10UF/150V	1.20	1.05	.90	.82
10UF/500V	3.50	2.90	2.60	2.25
16UF/475V	3.60	2.95	2.65	2.35
20UF/500V	3.70	3.40	2.80	2.55
20UF/600V	6.70	6.20	5.90	5.65
25UF/25V	.80	.75	.70	.65
25UF/50V	.85	.79	.73	.69
40UF/500V	4.95	4.35	3.80	3.15
50UF/50V	.90	.83	.77	.73
80UF/450V	5.50	4.80	4.20	3.70
100UF/100V	1.75	1.55	1.35	1.30
100UF/350V	4.45	4.05	3.65	3.25
100UF/450V	6.90	6.10	5.50	4.70
250UF/25V	1.25	1.10	.95	.85

ILLINOIS ELECTROLYTICS

Excellent replacement electrolytic capacitors for general purpose applications requiring tight ripple control. Axial leads, made in Japan.

	1	10	25	50+
22UF/500V	\$2.80	2.25	1.95	1.72
47UF/500V	4.75	3.80	3.35	3.20
80UF/450V	3.50	2.95	2.60	2.40
100UF/350V	2.80	2.30	2.10	1.95
100UF/450V	3.90	3.25	2.95	2.82
220UF/300V	4.00	3.65	3.35	3.10
5000UF/55V	1.90	1.80	1.70	1.65

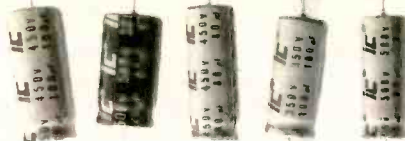

LCR CAPACITORS

Radial capacitors with solder lugs. Replacement for Marshall™, Hiwatt, Orange, Laney, Vox, Sound City & many others. Made in England.

	1	10	25+
32UF x 32UF @ 500 VOLTS	\$7.20	6.75	6.45
50UF x 50UF @ 500 VOLTS	7.45	6.95	6.70
100UF x 100UF @ 500 VOLTS	8.95	8.20	7.75
Mounting bracket/clamp	1.40	.90	.65

NEW SENSOR CORPORATION
20 Cooper Square, New York City, NY 10003 • (212) 529-0466 • 1-800-633-5477 • Fax (212) 529-0486
CIRCLE 258 ON FREE INFORMATION CARD

Value And Selection From One Source...

MCM ELECTRONICS®

To take advantage of these prices, you must supply this special price code:

CODE: ENS35



TENMA®

Autoranging DMM

Ideal for the tool box. Measures AC/DC voltage to 600V, DC current to 10A and resistance to 32Mohm.

#72-2050

Reg. \$62.95

Sale **\$39.95**



VCR Service Jig

Operates all VCR models including "G" chassis. Allows easy servicing of most VHS format VCRs.

#32-3840

Reg. \$12.45

Sale **\$9.99**

Prices Effective May 1 through June 14, 1997

Automobile 115VAC Power Inverter

Powers small AC powered devices from your automobile. Output 140W continuous, 200W surge.

#72-3090

Reg. \$79.95

Sale **\$59.95**



Diagnostic Test CD

Contains 40 tracks of test tones to evaluate, calibrate and measure audio systems performance.

#80-815

Reg. \$5.09

Sale **\$3.99**

30 Piece Security Screwdriver Bit Set

Includes special bits to remove tamper proof screws found in computer monitors, telephone equipment, cable boxes and more.

#22-1475

Reg. \$39.99

Sale **\$19.95**



1/2 PRICE!

VCR Model SuperCross™

Great for repair parts sourcing. Simply enter a VCR make and model and all makes that are mechanically the same are displayed.

Order #81-2055

Reg. \$29.95

Sale **\$24.95**



Same Day Shipping!

In stock orders received by 5:00 p.m. (YOUR TIME), are shipped the same day.

1-800-543-4330

Hours: M-F 7 a.m.-9 p.m., Sat. 9 a.m.-6 p.m., EST.



MCM ELECTRONICS®

650 CONGRESS PARK DR.
CENTERVILLE, OH 45459

A PREMIER FARNELL Company

FREE Catalog!

CODE: ENS35

AMAZING ELECTRONIC & SCIENTIFIC DEVICES

Lasers, Tesla, Ions, Anti-Gravity, Magnetics & More!
Plans • Ready-to-Use • Easy-to-Build Kits

Laser Ray Gun
 Handheld, battery operated. Produces an intense burst of light capable of burning holes.
 LAGUN2 Plans \$20.00
 LAGUN2K Kit / Plans Price on Req



250KV Tesla Coil
 10-14" of Explosive Bolts of Lightning!
 • Transmit Wireless Energy
 • Ion Motors
 • Anti-Gravity
 • Strange and bizarre pyrotechnical effects
 • Many other experiments shown in detail
 • Award winning science project!
 BTC3 Plans \$15.00
 BTC3K Kit/Plans with coil \$299.50
 BTC30 Assbid Ready to Use \$399.50
 BTC4 Plans, 500KV unit \$20.00



ATTENTION: Experimenters & Researchers!
 Anti-Gravity, Rail & Coil Guns, Mass Warping, Levitation Research, Exploding Water, Propulsion Drivers, Lattice Snapping, EMP etc. Loss-less Energy Charger with triggered spark switch. • Adjustable 500 to 3KV out
 • Charges up to 25KJ • Programmable Output
 HEP1 Plans \$15.00
 HEP1K Kit/Plans with 500J \$399.50
 HEP10 Lab Assembled - to your spec's.
 Write, call or fax for price & delivery
 ...shown connected to potential rail gun system



Visible Beam Gas Lasers
 Millions degree temp equiv. Illuminates low level clouds
 • Light Shows
 • Window Listener
 • Optical Projects
 • 12/115V
 • Science Project
 LAS1KM 1 mw, low cost Kit \$69.50
 LGU6K 2-3mw Kit \$119.50
 HNE70 5-7mw, ready to use \$299.50



Gravity Generator
 Levitate an object!
 Great science fair project!
 GRA1 Plans \$15.00
 GRA1K Power Supply Kit/Plans \$99.50
 GRA10 Assbid Kit/Plans \$149.50
 Includes text book on Anti-Gravity theory!



Solid State Tesla Coil
 • Generate fiery electrical plasma discharge
 • Powers light and objects without contact
 • Experiment with electrical and mechanical fields. TCL5 Plans \$8.00
 TCL5K Kit/Plans 12VDC \$49.50



Pioneer a Futuristic Weapon!
 Electric Gun - prototype designed in our lab - Join the research!
 • Ballistic Velocities
 • Handheld • Battery Operated
 • Labelled as DANGEROUS Product
 Experiment now before it is classified as a firearm! EGUN1 Plans \$20.00
 (Must be 21 for purchase of hardware)



Ion Ray Gun
 Project Energy!
 Star Wars technology demonstrates weapons potential. IOG7K Kit/Plans \$99.50



"Talking" Plasma Globe
 Spectacular color. Pulsates to music, sounds! 8-9", with intensity and sound controls. PLASMA1 Ready to Use \$79.50



Electronic Hypnotizer **Caution Required**
 Control their minds! Programmable audible and visual stimuli induces hypnotic trances. HYP2K Kit with Book \$39.95
 EH2 Hypnosis Book & Plans \$14.95



We can design and build high voltage systems - to your spec!
 Call or fax us with your requirements!

TACTICAL ELECTRONICS

Cybernetic Ear!
 Enhances normal hearing 3-4 times!
 Adjustable volume control, fits easily into either ear. Many, many uses.
 Ready to Use!
 CYBEREAR \$19.95



ALL NEW Telephone Line Grabber/Infinity Transmitter
 Use tone phone anywhere in the world to:
 • Monitor your premises - avoid break-ins
 • Access ongoing calls - longwinded kids
 • Control up to 8 appliances in your home!
 • Re-direct costly toll calls from pay phones!
 TELCON3 Plans (credit to purch) .. \$ 10.00
 TELCON3K Plans/KR \$99.50
 TELCON30 Ready to Use \$149.50



Long Range "Ultra-Ear"
 Parabolic Mic can hear a distant whisper!
 BUG Mother Nature!
 20" dish uses satellite technology to capture distant sounds. PMS5 Plans \$ 8.00
 PM5K Kit/Plans \$149.50
 • Optional Wireless Retrofit transmits captured sounds to an FM radio.
 WMSK Kit for Wireless Option ... \$29.50



Phasor Sonic Blast Pistol
 Rids areas of unwanted pests. Trains and conditions wild and domestic animals. Great for barns, attics, cellars, gardens.
 PPP1K Kit/Plans \$39.50



3 Mi Telephone Xmitter
 • Tune-able 80-130 Mhz • Undetectable
 • Only transmits when phone is used
 VWPM7K Kit/Plans \$39.50



3 Mi Voice Transmitter
 • Ultra-Sensitive Mike
 • Crystal Clear
 • Tunes 80-130 MHz.
 FMV1K Kit/Plans \$39.50



FireBall Gun
 Shoots flaming ball - two shot capacity. Great for special effects and remote fire starting. CAUTION REQUIRED!
 FIREBALL Plans (dangerous product) \$10.00



Shocker Force Field/Vehicle Electrifier
 Make hand and shock balls, shock wands and electrify objects. Great payback for those wiseguys!
 SHK1K Easy to Assemble Kit \$19.50



Extended Play Telephone Taping System
 • Tapes Phone Conversation • Extends Tape X4 • Check Local Laws before using!
 TAP30X Ready to Use \$84.50



"Drop-In" (Imi) Telephone Transmitter
 Easily tunable over FM radio. Never needs battery! #DROPIN Kit/Plans \$ 19.95



See in Total DARKNESS!
 • High Quality IR Night Vision
 Scope with IR illuminator.
 SD10 Ready to Use \$199.50



Electric Charge Gun
 Life is Precious - PROTECT IT!
 Stuns & immobilizes attackers 15 feet away! Check your state laws for legality. More knockdown power than most handguns. No permanent injury. ID coded. ECG1 Data
 (Creditable to purch) \$10.00
 ECG10 Charge Gun, Ready to Use, includes FREE Stun Gun! \$249.50
 STUN GUNS - sold separately:
 STUN100 100,000 Volts \$34.50
 STUN200 200,000 Volts \$49.50



3 Mi Tracker Transmitter
 • Tunable Output
 • Uses FM Radio
 • Excellent Signal Beacon
 HOD1K Kit/Plans \$39.50



MIND CONTROL!
 Places subjects under your control. Programmable audible & visual stimuli with biofeedback. Induces strange & bizarre hallucinations without drugs. Caution - not FDA approved.
 MIND2 Plans \$15.00
 MIND2K Kit and Plans \$49.50
 MIND20 Assembled Unit \$69.50



FANTASTIC BRIGHTNESS!
 High Quality Laser Pointer
 LAPN64 15mw equiv, 2000' \$39.50
 LAPN61 50mw equiv, 4000' \$84.50



Window Bounce Laser Listener
 Aim at window and listen to sounds from reflected light. CAUTION - Not for illegal use. LWB3 Plans \$10.00
 LWP3K Kit/Plans (req's vid tripod) \$149.50



1000' Potato Cannon
 Not a Toy! Uses electronic or piezo ignition. CAUTION REQUIRED!
 POT1 Plans (dangerous product) ... \$10.00



VISIT US ON THE WEB!
<http://www.amazing1.com>

INFORMATION UNLIMITED

Dept ENS-7, Box 716, Amherst, NH 03031
 Phone: 603-673-4730 FAX: 603-672-5406
 MC, VISA, COD, Checks accepted Please add \$5.00 S & H

CATALOG! FREE with Order or send \$1 P&H
24 Hour Phone 800-221-1705
 Orders Only Please!

PROFESSIONAL DESOLDERING with the

Lane Norman - Normans Electronics Inc. Atlanta GA 404-451-5057
A cost effective solution to desoldering equipment at less than half the price of most equipment. It's performance is ASTOUNDING.

We have obtained excellent results with the SC7000 including repairing high density U/V tuners. It is one of the best purchases we have made.

Mike Murphy - Service Center - Van Nuys CA 818-785-7805

The single best investment of repair equipment we've made. It outperforms all other desoldering tools we've used. Easier to use and least expensive.

More Suction

Bob Monroe - M.A.R.C. Electronics - Virginia Beach VA 804-468-3932
Best investment we've made. Saves time, especially with multi-sided PCB's. Extremely pleased with warranty. Failed within 6 months and replaced by DEN-ON overnight.

Quicker Vacuum

Dick Manning - Dicks Electronics - Hartland WI 414-367-8339
The ease & speed of component removal greatly increases productive time. The SMD kit makes SMD removal a breeze, even for inexperienced Techs.

Higher Temperature

George Hefner - Hefner Electronics - Coleridge NE 402-283-4333
Being a one-man service center, I hesitated to spend the money on a desoldering tool, however all that changed when I nearly ruined a \$400 computer logic board. It has cut my desoldering time by 50%.

Same Low Price

Don Cressin - Certified Electronics Service - Ellicott City MD 301-461-8008

New & Improved DEN-ON SC7000Z

New Features

- ◆ Totally Self Contained diaphragm vacuum pump and AC motor for high vacuum suction or reversible hot air blow for SMD removal.
- ◆ 100Watt Ceramic heater with zero-crossover switching heater control circuit which prevents spikes and leakage currents.
- ◆ Unique patented long lasting filter cartridge design. Solder builds up on easily cleaned baffle, while air flows around the outside of baffle.
- ◆ Totally ESD Safe. The housing contains carbon and the tip is at ground potential for complete ESD Protection.
- ◆ Maximum vacuum of 650mmHg is attained in 100 milliseconds.
- ◆ Temperature adjustable from 300°C - 500°C (572°F - 932°F).
- ◆ More suction power and hotter temperature if needed.



FREE TRIAL

Available on Request

Sale Price
\$375.00

Price includes
extra filter, and
two tip cleaners.

5400

We found that the SC7000 not only saves money vs. wick, but saves valuable time in troubleshooting. It allows you to be more accurate in removing SMD's.

Randy Whitehead - Service West - Salt Lake City UT 801-262-4069
My techs thought it would be a waste. I bought one anyway after a demo. My techs then thought over it. Now we have three. It is the Best desoldering tool we have ever used.

Timothy Kraft - Monikraft, Inc. - Cherry Hill NJ 609-751-3252
We replaced all our existing desoldering stations with the SC7000. Our technicians are very pleased with the improved performance, portability, and reliability over our previous higher priced equipment.

Bill Warren CET/CSM - Warrens Audio & Video - Knoxville TN - 234-546-1128
We have been extremely satisfied with the quality and durability of the DEN-ON SC7000 as well as with after the sale support.

Keith Sals - J & M Electronics - Omaha NE 402-291-7100
It's a must tool for my bench. I can desolder multiple pin IC's quickly and clean. It will even take up large solder amounts on tuner and case grounds.

Daryl Baker Servus Electronics Wichita KS
The SC7000 is a better product than advertised. It has more than paid for the initial investment. We highly recommend the SC7000 Desoldering Tool.

New Specifications

- ◆ Voltage ————— AC100v, 120V, 230V, 50/60HZ
- ◆ Power Consumption ——— 120W
- ◆ Pump ————— Diaphragm Type
- ◆ Motor Output ————— 12W
- ◆ Vacuum Attained ——— 650mmHg
- ◆ Temperature Range ——— 300°C — 500°C (572°F — 932°F)
- ◆ Air Flow Rate ————— 15 Liter/Minute (Open)
- ◆ Heater ————— 100W (Ceramic)
- ◆ Control System ————— Feed Back Zero Cross-over Type
- ◆ Net Weight ————— 420Grams
- ◆ Max. Temp. of Hot Blow — 400°C

Visa - M/C - Discover - American Express - Terms to Qualifying Companies
30 Day Money Back Total Satisfaction Guarantee - One Year Parts and Labor Warranty

HOWARD
HEIN ELECTRONIC
INSTRUMENTS **INC**
Your Desoldering Specialists

Toll Free U.S. and Canada
1-800-394-1984

Web Site www.heinc.com
E-Mail sales@heinc.com
International (316) 744-1993
or Fax (316) 744-1994

CIRCLE 333 ON FREE INFORMATION CARD

BLOWOUT! TIMELINE INC. BLOWOUT!

Over 10 years and 28,000 customers and still growing

LIQUID CRYSTAL DISPLAYS

240x64 dot LCD with built-in controller.
 AND 4021ST-EO. Unit is EL back-lit. \$69.⁰⁰ or 2 for \$129.⁰⁰ or
 OPTREX DMF5005 (non back-lit) \$49.⁰⁰ or 2 for \$89.⁰⁰
 20 character x 8 line 7xL x 2xH The built-in controller allows you to do text and graphics.

Alphanumeric—parallel interface

16x1.....\$7.00	20x2.....\$10.00	40x1.....\$8.00
16x1 (lg. char.).....\$10.00	20x4.....\$15.00	40x2.....2 for \$20.00
16x2.....\$7.00	20x4 (lg. char.).....\$10.00	40x4.....\$20.00
16x2 (lg. char.).....\$10.00	24x2.....\$10.00	4x2.....\$5.00
16x4.....\$15.00	32x4.....\$10.00	

5V power required • Built-in C-MOS LCD driver & controller • Easy "microprocessor" interface • 98 ASCII character generator • Certain models are backlit, call for more info.

Graphics and alphanumeric—serial interface

size	Mfr.	price	size	Mfr.	price
640x480 (backlit)	Epson	\$25.00	480x128	Hitachi	\$10.00
640x400 (backlit)	Panasonic	\$20.00	256x128	Epson	\$20.00
640x200	Toshiba	\$15.00	240x128 (backlit)	Optrex	\$20.00
480x128 (backlit)	ALPS	\$10.00	240x64	Epson	\$15.00
			160x128	Optrex	\$15.00

6" VGA LCD 640X480, Sanyo LMDK55-22 \$25⁰⁰

LASER PRODUCTS

HeNe Laser Head (10mW max. output) TEM00. 15.5" long MFG: NEC \$99.⁰⁰
Laser Power Supply (for HeNe tube) \$89.⁰⁰

LASER SCANNER ASSEMBLY \$19.⁰⁰

Assembly intended for a laser printer. Includes laser diode, polygon motor (6 sided) and misc. optics and lenses.

LASER DIODE (5mW) with collimator \$20.⁰⁰

VISIBLE LASER DIODE: 5mw at 670nm \$15.⁰⁰
 Index guided. Threshold current 40 ma typical.

3 and 4mW, 1,300nm LASER DIODES, 5.6mm package, \$15⁰⁰
Mitsubishi Electric part number ML701BIR-E21A, General specs are:
 1. Vop=1.25, Beam Divergence 25.6° x 28.6°; 2. Tc=24°C, Iop=19 to 20mA,
 ITH=10.7mA; 3. Wavelength range between 1,280nm and 1,330 nm

POLYGON MOTOR UNIT & DRIVER \$79⁰⁰
 Ten-sided first surface mirror mounted on an armature that spins at 125 revolutions per second yielding a beam sweep rate of 1250 sweeps per second. The driver for the polygon unit requires 24 volts and plus and minus 12 volts to operate. There is also an f-beta lens in front of the polygon scanning mechanism with a three inch diameter. Great for optical experiments, etc. Very high quality units. (MFR: JAPAN ELECTRONICS)

NETWORK

Proton ProNet-4 Model p1347 Token Ring Board \$49.⁰⁰
 16 bit • 4 Mbps • IEEE 802.2 and 802.5 compatible • twisted pair • Interoperable with IBM Token Ring network

POS & BAR CODE

MAGNETIC CARD READER \$25.⁰⁰

Includes: • 20 character dot matrix display with full alpha-numeric capability • keypad with full alpha-numeric entry • separate 7.5 VDC/0.5 Amp power supply • standard telephone interface extension cord • lithium battery and flat-cone speaker.

HP bar code wand (HBCS 2300).....\$25.00

POWER SUPPLYS

SWITCHING POWER SUPPLYS \$12.00 or 2 for \$20.00 115/230 Volts
73 WATT (2) 4 pin power connectors attached • Dim: 8.5" L x 4.5" W x 2" H
 Output: +5V @ 2-9.75 A, +12V @ 0-1.5 A, -5V @ 0-0.4 A, -12V @ 0-0.5 A
68 WATT Dim: 5.5" L x 3.2" W x 1.7" H • Output: 5V @ 4 A, 12V @ 4 A
60 WATT Dim: 8 1/2 x 4 1/2 x 3 • Output: 5V @ 6A + 12V @ 1A - 5V @ 1A - 12V @ 1A

CHARGE COUPLED DEVICES



"The Spy In The Sky" \$49.⁰⁰ MATRIX TYPE

Thomson 576X550 pixel CCD
 400-1,100nm resolution and responsivity. \$500⁰⁰ Original cost device

Sony CCD Imager - designed for black and white composite video cameras. Picture elements: 384 (H) x 491 (V) \$29⁰⁰
 Chip size 10.7 (H) x 9.3 (V) mm² • Unit cell size 23.0 (H) x 13.4 (V) um².
 Ceramic 24 pin DIP package • Mfr: Sony, Part# 016AL

4096 element CCD \$15.00

1024 element CCD \$10.00

2048 element CCD \$10.00 • 1728 element CCD \$10.00

LINEAR TYPE

2539 W. 237th Street, Bldg. F, Torrance, CA 90505
 Order desk only: **USA: (800) 872-8878 CA: (800) 223-9977**
 L.A. & Technical Info: **(310) 784-5488 Fax: (310) 784-7590**
OEM INQUIRIES WELCOME

MONITORS

Non-Enclosed TTL

Comes with pinout. 12V at 1.4 Amp input • Horizontal frequency 15KHz. • Ability to do 40 and 80 column.
5 inch Amber \$25.00 • 7 inch Amber \$25.00
9 inch Amber or Green \$25.00

5" COLOR MONITOR \$39.⁰⁰

• Flat Faceplate • 320 x 200 Dot Resolution • CGA & Hercules Compatible
 • 12 VDC Operation • 15.75 KHz Horiz. Freq. • 60 Hz Vert. Sync. Freq.
 • Open Frame Construction • Standard Interface Connector • Degaussing Coil included • Mfr. Samtron



9" monochrome SVGA MONITOR \$79.⁰⁰
 Fully Enclosed - Tilt and swivel type. Mfr: WEN

MISCELLANEOUS

ADAPTEC 4070A (RL) OR 4000A (MFM), SCSI Controller, your choice \$25⁰⁰

IBM 370 option XT and AT emulation boards \$25⁰⁰

HACKER CORNER

US made Micronics 486 VLB ALL in ONE \$69⁰⁰ or 2 for \$129⁰⁰

motherboard, supports 3.4 or 5V CPU, at either 25 or 33 mhz basic clock. Can use AMD or Intel from 486SX25 thru 486DX4-100 to HOT new AMD 5X86-133 cpu. On board SVGA video. On board 1 meg video ram expandable to 2 meg with ATI Mach 2 chip set. On board 2 high speed serial ports, 1 printer port, floppy and IDE hard drive controller. On board 256K cache. Uses 72 pin simm memory. Landmark speed rating of 479 with AMD chip.

Board will not fit standard All in One case because of non standard location of riser board. VLB riser board is included with motherboard.

CAMERA BLOCK \$99⁰⁰ or 2 for \$169⁰⁰

FOR ROBOTICS AND EVERYTHING ELSE

Unit is for Hi Band 8mm CamCorders, includes 8X zoom lenses, D/D converters, built-in CCD 2/3 in, 420 thousand picture elements, complementary mosaic filters. Excellent performance. High resolution, high sensitivity, low lag, low smear, good color reproduction, no distortion, 1/60-1/10000sec variable speed digital shutters, TTL auto focus, auto white balance, one-push auto white balance, auto/manual iris and gain up switch. Can be controlled by a 4bit micro computer. Remote controlling is possible for zoom and focusing. NOTE: These are PAL (European Standard) Units. MFR: SONY

CELL SITE TRANSCEIVER \$79⁰⁰ 2 for \$149⁰⁰

These transceivers were designed for operation in an AMPS (Advanced Mobile Phone Service) cell site. The 20 MHz bandwidth of the transceiver allows it to operate on all 666 channels allocated. The transmit channels are 870.030-889.980 MHz with the receive channels 45 MHz below those frequencies. A digital synthesizer is utilized to generate the selected frequency. Each unit contains two independent receivers to demodulate voice and data with a Receive Signal Strength Indicator (RSSI) circuit to select the one with the best signal strength. The transmitter provides a 1.5 watt modulated signal to drive an external power amplifier. Channel selection is accomplished with a 10 bit binary input via a connector on the back panel. Other interface requirements for operation are 26 VDC (unregulated) and an 18.990 MHz reference frequency for the digital synthesizer. The units contain independent boards for receivers, exciter, synthesizer, tunable front end, and interface assembly (which includes power supplies and voltage-controlled oscillator). Service manual, schematics and circuit descriptions included.

Encased Black & White Composite CCD Camera with Adapter

IR viewing to 1000 nm 7 1/2 L x 2 1/4 W x 1 1/4 H \$89.00
 Comes complete with CCD camera, mounting nut on bottom of casing, 12VDC power supply. Excellent low light capability, standard RCA NTSC video out.
Great for: entryway security/remote monitoring, video conferencing/desktop video conferencing 2 for \$159.00

This miniature camera is perfect for multimedia computer applications as well as security and surveillance. NTSC output allows use with all popular video digitizing boards for Apple Macintosh and Microsoft video for Windows. Connects directly to any composite monitor or VCR with "video" input. Its razor-sharp wide-angle lens focuses from two inches to infinity and its state-of-the-art CCD technology accurately captures 16 level grayscale images for Quick Time movies and still pictures. Records at 30 frames per second and 260 lines resolution with excellent low light capability. Uses 12VDC (adapter supplied) and standard RCA cable.

POINT OF SALE BANK TERMINAL \$39⁰⁰ or 2 for \$69⁰⁰

• LCD Display 20 Char. x 4 Line • Printer 16 Column Dot Matrix • Epson • 24 Key Domed Membrane Keypad • Intel 80C32 Processor • 2 PCMCIA Sockets (ICC Slots) • Dallas DS1287 Realtime Clock • 2 Solid State Buzzers (Piezo Electric) • 4 Crystals • Rockwell Modem Chip • Telephone Line Interface (4 Pin "RJ" Connector) • RS-232 Interface (8 Pin "RJ" Connector) • Ni-CAD Battery Pack Inside
 Note: We have not been able to bypass an access code in the software. Thus, while time of day and other introductory things are displayed on LCD, the full original capabilities of this unit cannot be guaranteed. Also, we do not have a source for the smart cards that were to go in the PCMCIA sockets. Requires 12 volt adapter for power. (Not included) Dimensions: 9-1/2L x 6-1/4W x 2-1/2 D • Original cost over \$450.00

6" COMPOSITE MINIATURE COLOR DISPLAY \$99.⁰⁰

Fully encased. Dim: 1.3" x 1.3" x 1.1" • 12VDC power. NTSC signal.
 250 H x 300 V resolution. Fully adjustable. Replaceable. Applications include camcorder viewfinder, handheld mounted display, etc... Original cost over \$600.00

Minimum Order: \$20.00. Minimum shipping and handling charge \$5.00. We accept cashiers checks, MC or VISA. No personal checks or COD's. CA residents add 8.25% sales tax. We are not responsible for typographical errors. All merchandise subject to prior sale. Phone orders welcome. Foreign orders require special handling. Prices subject to change without notice. 20% restocking fee for returned orders.

Digital Entertainment
also available through
Skyvision



USB



AlphaStar

4D TV
FOR C-BAND



BEST Values from Skyvision!

Receivers
from \$259
including 4DTV

Dish Movers
12" to 52" for all
C- and Ku-band dishes

LNBS
All kinds
to heat up your picture

Tune-Up Kits
for C/Ku band & DBS

Programming
Save 30% - 50% with Skypac™

Support
Customers enjoy toll-free technical help

Keep your C-band System Running Strong

Everything on the arc for complete variety

Enjoy debut of new channels
Offer in the clear for months

Wild feeds... Action as it happens

Programming you want at a price
you can afford to pay

Whether you're considering your first
satellite TV entertainment system or
looking for an upgrade to your
current system, Skyvision provides
the best in hardware, technical
support, convenience,
low cost and service.

1046 Frontier Drive
Fergus Falls, MN 56537

All marks shown are registered trademarks
of their respective owners.

Fax: 218-739-4879 Int'l: 218-739-5231

1-800-334-6455
www.skyvision.com

Skyvision

CIRCLE 270 ON FREE INFORMATION CARD

Our Complete Catalog is now online

http://www.cir.com

CIRCUIT SPECIALISTS INC.

Check Out What We Have To Offer:

Fantastic DMM Offer!!!

Don't let the price fool you. This meter is a digital multimeter designed for engineers and hobbyists. Equipped with 5 functions and 19 ranges. Each test position is quickly and easily selected with a simple turn of the FUNCTION/RANGE selector rotary switch.

Rubber Boot Included

General

Display: 3-1/2 Digit LCD, 21mm Figure Height

with Automatic Polarity

Overrange Indication: 3 Least Significant

Digits Blank

Temperature for Guaranteed Accuracy:

23°C±5°C RH<75%

Temperature Ranges:

Operating: 0°C to 40°C (32°F to 104°F)

Storage: -10°C to 50°C (14°F to 122°F)

Power: 9V Alkaline or Carbon-Zinc Battery (NEDA1604)

Low Battery Indication: BAT on Left of LCD Display

Dimensions: 188mm long x 87mm wide x 33mm thick

Net Weight: 400g

DC Voltage (DCV)

Range: Resolution: Accuracy:

200mV 100µV

2000mV 1mV

20V 10mV

200V 100mV

1000V 1V

Maximum Allowable Input: 1000V DC or Peak AC.

DC Current (DCA)

Range: Resolution: Accuracy:

200µA 100nA

2000µA 1µA

20mA 10µA

200mA 100µA

10A 10mA

Overload Protection: mA Input: 2A/250V fuse.

AC Voltage (ACV)

Range: Resolution: Accuracy:

200V 100mV

750V 1V

Frequency Range: 45Hz-450Hz

Maximum Allowable Input: 750V rms

Response: Average Responding. Calibrated in rms of a Sine Wave.

CAT NO	DESCRIPTION	PRICE
9300G	Rugged High Quality DMM with Rubber Boot	\$19.00

\$19.00 any qty



Our Best Offer Ever on a

High Quality Full Sized DMM

Resistance (Ω)	Range:	Resolution:	Accuracy:
200Ω	200Ω	100mΩ	
2000Ω	1Ω		
20KΩ	10Ω		±(1.2%rdg+2dgt)
200KΩ	100Ω		
2000KΩ	1KΩ		
20MΩ	10KΩ		±(2%rdg+10dgt)

Maximum Open Circuit Voltage: 2.8V

Diode Test
Measures forward voltage drop of a semiconductor junction in mV test current of 1.5mA Max.

ohFE Test
Measures transistor hFE.

Switchable Scope Probe Sets
(Selectable X1/Ref/X10) These high quality scope probe sets are for oscilloscopes up to 60MHz (model HP 9060) or 150MHz (model HP9150). Both sets include a handy storage pouch and include an IC test-hook adapter for the probe. The BNC connector rotates to avoid cable tangle or kink. Cable length is 1.4 meters.

CAT NO	DESCRIPTION	1	10	100
HP-9060	Scope Probe Set DC~60MHz	\$16.49	\$14.49	\$11.58
HP-9150	Scope Probe SetDC~150MHz	24.95	21.95	18.62

Etching Chemicals/Ferric Chloride
A dry concentrate that mixes with water to make 1 pint of etchant, enough to etch 400 sq. inches of 1oz board.

CAT NO	DESCRIPTION	1	5
ER-3	Makes 1 pint	\$3.50	\$2.75



Positive Photo Resist Pre-Sensitized Printed Circuit Boards

These pre-sensitized printed circuit boards are ideal for small production runs. They provide high resolution and excellent line width control. High sensitive positive resist coated on 1oz. copper foil allows you to go direct from your computer plot or art work layout. No need to reverse art.

Single-Sided, 1oz. Copper Foil on Paper Phenolic Substrate

CAT NO	DESCRIPTION	1	10	50
PP101	100mm x 150mm/3.91" x 5.91"	\$2.55	\$1.90	\$1.70
PP114	114mm x 165mm/4.6" x 6.6"	2.98	2.45	1.98
PP152	150mm x 250mm/5.91" x 9.84"	5.40	3.98	3.60
PP153	150mm x 300mm/5.91" x 11.81"	6.15	4.48	4.10
PP1212	305mm x 305mm/12" x 12" NEW!	12.78	10.65	8.52

Double-Sided, 1oz. Copper Foil on Fiberglass Substrate

CAT NO	DESCRIPTION	1	10	50
GS101	100mm x 150mm/3.91" x 5.91"	\$ 3.90	\$2.98	\$2.60
GS114	114mm x 165mm/4.6" x 6.6"	4.80	3.49	3.20
GS152	150mm x 250mm/5.91" x 9.84"	8.69	5.98	5.78
GS153	150mm x 300mm/5.91" x 11.81"	10.20	7.20	6.80
GS1212	305mm x 305mm/12" x 12" NEW!	18.88	15.73	12.59

Developer This product is used as the developer on our positive photo-resist printed circuit boards. Includes instructions. 50 gram package, mixes with water, makes 1 quart.

CAT NO	DESCRIPTION	1	10	25
POSDEV	Positive Developer	\$.95	\$.80	\$.50



Etching Tank This handy etching system will handle PC boards up to 8" x 9", two at a time. Ideal for etching your PCB's! System includes an air pump for etchant agitation, a thermostatically controlled heater for keeping etchant at optimum temperature and a tank that holds 1.35 gallons of etchant. A tight fitting lid is also supplied to prevent evaporation when system is not being used. Typical etching time is reduced to 4 minutes on 1oz. copper board!

REDUCES ETCHING TIME!

CAT NO	DESCRIPTION	PRICE
12-700	Etch Tank System	\$37.95

Removeable Hard Drive Racks
The ideal solution for protecting highly sensitive data. Or, buy one computer and allow individual users to keep their hard drive with their own applications and set-ups. Just turn the system off, lift the handle and the hard drive pops right out. Key lock included to avoid accidental or unauthorized removal. Includes hard drive activity LED's. Rack includes mounting hardware, keylock, front panel LED, convenient pull out handle. Made from high impact ABS plastic. Fits in 5.25" bay.

Features: • Ideal for Hard Drive Portability • Solve Software Data Security Issues • Carry Your Hard Drive Between Home and Office • Each User Can Have His or Her Personal Hard Drive



CAT NO	DESCRIPTION	PRICE
SpecialHDRACK-IDE	For IDE Hard Drive	\$14.95

SEE OUR ON-LINE CATALOG AT
www.cir.com

Digital Panel Meters (LCD & LED)

Don't let the prices fool you. These digital panel meters are not surplus, so even if you design them into an ongoing manufactured product, you can be assured of continued availability. These high quality digital panel meters are decimal point selectable with guaranteed zero reading at zero volts input.



Applications Include:

- Voltmeter
- Thermometer
- pH Meter
- dB Meter
- Watt Meter
- Current Meter
- Capacitance Meter
- LUX Meter
- LCR Meter
- Other Industrial & Domestic Uses

PM-128: 3-1/2D LCD Digital Panel Meter

PM-129: 3-1/2D LED Digital Panel Meter

Features

- 200mV Full Scale Input Sensitivity
- PM-128 - Single 9VDC Operation
- PM-129 - Single 9VDC Operation
- Decimal Point Selectable
- PM-128 - 13mm Figure Height
- Automatic Polarity Indication
- Guaranteed Zero Reading for 0 Volt Input
- High Input Impedance (>100Mohm)

Specifications - PM-128/PM-129

Maximum Input : 199.9mV DC
 Maximum Display : 1999 counts (3-1/2 Digits)
 w/Automatic Polarity Indication
 Indication Method : PM-128 - LCD Display
 PM-129 - LED Display
 Measuring Method : Dual-Slope Integration
 A/D Converter System
 Overrange Indication : "1" Shown In the Display
 Reading Rate Time : 2-3 Readings per sec.
 Input Impedance : >100 Mohm
 Accuracy : +/-0.5% (23+/-5°C, <80% RH)
 Power Dissipation : PM-128 - 1mA DC
 PM-129 - 60mA DC
 Decimal Point : Selectable w/Wire Jumper
 Supply Voltage : PM-128 - 9V DC
 PM-129 - 9V DC
 Size : 67mm x 44mm

Specifications - PM-328

Maximum Input : 199.99mV DC
 Maximum Display : 19999 counts (4-1/2 Digits)
 w/Automatic Polarity Indication
 Indication Method : LCD Display
 Overrange Indication : "1" Shown in the Display
 Input Impedance : >100 Mohm
 Accuracy : +/-0.05% (23+/-5°C, <80% RH)
 Power Dissipation : 1mA DC
 Decimal Point : Selectable w/Wire Jumper
 Supply Voltage : 9V DC
 Size : 67mm x 44mm

AS LOW AS \$5.25 ea.

CAT NO	DESCRIPTION	PRICE EACH				
		1	10	25	100	250
PM-128	3-1/2 Digit LCD Panel Meter	\$ 9.90	\$ 7.09	\$ 6.40	\$ 5.86	\$ 5.25
PM-129	3-1/2 Digit LED Panel Meter	11.49	9.54	8.67	7.95	6.95
PM-328	4-1/2 Digit LCD Panel Meter	19.88	16.40	14.90	13.66	11.93



Ball Bearing 12V DC Fans

These High Quality Fans feature Ball Bearings and Brushless DC Motors. All of them are designed to meet UL, CSA & VDE Standards. Design these fans into power supplies, computers or other equipment requiring additional air flows for heat removal. These fans are regular Circuit Specialists stock items — they are not surplus.

INDUSTRY BEST PRICING!

CAT NO	PRICE EACH			
	1	10	25	100
CSD 4010-12	\$ 9.88	\$ 6.38	\$ 5.48	\$ 4.87
CSD 6025-12	9.38	5.91	5.41	4.71
CSD 8025-12	8.88	5.85	5.19	4.49
CSD 9225-12	8.95	6.14	5.29	4.59
CSD 1225-12	11.45	8.96	7.82	6.85

Specifications

CAT NO	DIMENSIONS (MM)	RATED VOLTAGE (V)	START VOLTAGE (V)	INPUT CURRENT (A)	AIR FLOW (CFM)	STATIC PRESSURE (INCH-H ₂ O)	SPEED (RPM)	NOISE LEVEL (dB)	WEIGHT (g)
CSD 4010-12	40x40x10mm	12	7	0.06	5.1	0.19	5,500	26	20
CSD 6025-12	60x60x25mm	12	5	0.13	13.7	0.165	4,500	28	65
CSD 8025-12	80x80x25mm	12	5	0.16	37.8	0.177	3,000	31	80
CSD 9225-12	92x92x25mm	12	5	0.32	42	0.18	2,800	37	95
CSD 1225-12	120x120x25mm	12	5	0.35	62	0.180	2,500	42	135

- SOLDER • SOLDER • SOLDER • SOLDER

We stock high quality 60/40 (Sn%/Pb%), .031" and 63/37, .031" diameter. This is prime JIS certified solder that we maintain as a regular stock item (It is not "Left-overs, Rejects or Surplus") and you can buy it from us at a fraction of the price that you are used to.

Tired of Paying Inflated Prices for Solder?

CAT NO	DESCRIPTION	PRICE EACH		
		1	10	25
RH60-1	1-lb. Spool, .031", 60/40	\$ 6.90	\$ 5.96	\$ 5.30
RH63-1	1-lb. Spool, .031", 63/37	6.95	6.10	5.41
RH60-4	4.4-lb. Spool, .031", 60/40	24.00	21.90	17.92
RH60-TUBE	6-oz. Tube, .031", 60/40	.99	.89	.79



CCD Camera - IR Responsive

As Low As \$85!!

This black and white monochrome CCD Camera is totally contained on a PCB (70mm x 46mm). The lens is the tallest component on the board (27mm high from the back of the PCB) and it works with light as low as 0.1 lux. It is IR Responsive for use in total darkness. It comes with six IR LED's on board. It connects to any standard monitor, AUX or video input on a VCR or through a video modulator to a TV. Works with a REGULATED 12V power supply (11V-13V). Hooks up by connecting three wires: red to 12V, black to ground (power & video) and brown to video signal output.



Power Supply Regulating Kit for CA-H34 This simple kit is designed to fit onto the back of the CA-H34 CCD camera. It resolves the problem of hooking up the camera to an UNREGULATED supply (which damages the camera) by providing safe regulated power from any 12V-14V DC supply. It also provides regulated 12V DC from a 12V AC source.

CAT NO	DESCRIPTION	PRICE EACH	
		1	5
CA-H34A	PCB Mounted IRCCD Camera	\$99.00	\$85.00
A34	Power Supply Regulating Kit	\$6.95	----

SEE OUR ON-LINE CATALOG AT www.cir.com

CIRCUIT SPECIALISTS, INC.

SINCE 1971

800-811-5203
 602-464-2485
 602-464-5824 (FAX)

WE ACCEPT:



RECEIVE OUR LATEST 132 PAGE CATALOG!

It's chock full of all types of electronic equipment and supplies. We've got I.C.'s, capacitors, resistors, pots, inductors, test equipment, breadboarding supplies, PC supplies, industrial computers, data acquisition products, personal computers and computer parts, plus much, much more. FAX us your name and address or call 800-811-5203, ext. 5, to leave a message on our catalog request line.



USE ELECTRONICS NOW CLASSIFIEDS

READ BY ELECTRONIC BUYERS AND SELLERS AND TRADERS

INSTRUCTIONS FOR PLACING YOUR AD!

HOW TO WRITE YOUR AD

TYPE or **PRINT** your classified ad copy **CLEARLY** (not in all capitals) using the form below. If you wish to place more than one ad, use a separate sheet for each additional one (a photo copy of this form will work as well). Place a category number in the space at the top of the order form (special categories are available). If you do not specify a category, we will place your ad under miscellaneous or whatever section we deem most appropriate.

We cannot bill for classified ads. **PAYMENT IN FULL MUST ACCOMPANY YOUR ORDER.** We do permit repeat ads or multiple ads in the same issue, but in all cases, full payment must accompany your order.

WHAT WE DO

The first word and company name of each ad are set in bold caps at no extra charge. No special positioning, centering, dots, extra space, etc. can be accommodated.

RATES

Our classified ad rate is \$2.50 per word. Minimum charge is \$37.50 per ad per insertion (15 words). Any words that you want set in bold are each .40 extra. Indicate bold words by underlining. Words normally written in all caps and accepted abbreviations are not charged anything additional. State abbreviations must be post office 2-letter abbreviations. A phone number is one word.

If you use a **Box** number you must include your permanent address and phone number for our files. **ADS SUBMITTED WITHOUT THIS INFORMATION WILL NOT BE ACCEPTED.**

For firms or individuals offering Commercial products or Services. **Minimum 15 Words.** 5% discount for same ad in 6 issues within one year; 10% discount for same ad in 12 issues. **Boldface** (not available as all caps), add .40 per word additional. **Entire ad in boldface**, add 20%. **Tint screen behind entire ad**, add 25%. **Tint screen plus all boldface ad**, add 45%. **Expanded type ad**, add \$4.00 per word.

General Information: A copy of your ad must be in our hands by the 13th of the fourth month preceding the date of issue (i.e. Sept issue copy must be received by May 13th). When normal closing date falls on Saturday, Sunday or Holiday, issue closes on preceding work day. Send for the classified brochure.

DEADLINES

Ads not received by our closing date will run in the next issue. For example, ads received by November 13 will appear in the March issue that is on sale January 17. **ELECTRONICS NOW** is published monthly. No cancellations permitted after the closing date. No copy changes can be made after we have typeset your ad. **NO REFUNDS**, advertising credit only. No phone orders.

CONTENT

All classified advertising in **ELECTRONICS NOW** is limited to electronics items only. All ads are subject to the publishers' approval. **WE RESERVE THE RIGHT TO REJECT OR EDIT ALL ADS.**

AD RATES: \$2.50 per word. Minimum \$37.50

Send you ad payments to:

ELECTRONICS NOW 500 Bi-County Blvd, Farmingdale, NY 11735-3931

CATEGORIES

100 - Antique Electronics	270 - Computer Equipment Wanted	450 - Ham Gear Wanted	630 - Repairs-Services
130 - Audio-Video Lasers	300 - Computer Hardware	480 - Miscellaneous Electronics For Sale	660 - Satellite Equipment
160 - Business Opportunities	330 - Computer Software	510 - Miscellaneous Electronics Wanted	690 - Security
190 - Cable TV	360 - Education	540 - Music & Accessories	710 - Telephone
210 - CB-Scanners	390 - FAX	570 - Plans-Kits-Schematics	720 - Test Equipment
240 - Components	420 - Ham Gear For Sale	600 - Publications	730 - Wanted

CLASSIFIED AD COPY ORDER FORM

Place this ad in Category # _____

Special Category \$30.00 Additional _____

1 - \$37.50	2 - \$37.50	3 - \$37.50	4 - \$37.50
5 - \$37.50	6 - \$37.50	7 - \$37.50	8 - \$37.50
9 - \$37.50	10 - \$37.50	11 - \$37.50	12 - \$37.50
13 - \$37.50	14 - \$37.50	15 - \$37.50	16 - \$40.00
17 - \$42.50	18 - \$45.00	19 - \$47.50	20 - \$50.00
21 - \$52.50	22 - \$55.00	23 - \$57.50	24 - \$60.00
25 - \$62.50	26 - \$65.00	27 - \$67.50	28 - \$70.00

29 - \$72.50	30 - \$75.00	31 - \$77.50	32 - \$80.00
33 - \$82.50	34 - \$85.00	35 - \$87.50	36 - \$90.00
37 - \$92.50	38 - \$95.00	39 - \$97.50	40 - \$100.00

Total words _____ \$2.50 per word = \$ _____
 Bold Face _____ \$0.40 per word = \$ _____
 Special Heading _____ \$30.00 = \$ _____
 Other _____ = \$ _____

Total classified ad payment \$ _____ enclosed

TOTAL COST OF AD \$ _____

Check Mastercard Visa Discover Card # _____ Expiration Date ____/____

Signature _____

Name _____ Phone _____

Address _____ City State Zip _____

AM/FM SPORTS HEADPHONE RADIO

Bright yellow sports headphone radio features operation from 2 AA batteries (not included) and AM/FM reception. Headband is fully adjustable and features volume tuning and AM/FM selector switch. These are factory refurbished units that have been restored to original specs!



G8323

\$7.95

AM/FM STEREO HEADPHONE RADIO

Deluxe stereo headphone radio features beautiful stereo sound on FM and great sounding AM reception. Made by Gran Prix (GPX). These very comfortable headphones are fully adjustable and precision made. Matte finish black color. There are dealer or customer returns that have been factory refurbished and tested to original specs. You'll be impressed with the quality and the sound. Operates on 2AAA batteries (not included). Worth much more than our low price!



G8322

\$12.95

ON GUARD® HOME ARREST OFFENDER MONITORING DEVICES

These are complete home arrest monitoring devices that were, and probably still are, in use throughout the US and various parts of the World to monitor "offenders" that were assigned early release from prison. The monitor consists of a sophisticated small transmitter unit that was worn on the ankle or wrist, and an On Guard® receiver control unit which was plugged into a wall outlet and a phone jack. The receiver kept track of the offender and would notify the police departments central monitoring unit if the offender left the house at the wrong time. It kept track of the offender 24 hours a day. It also had a Verifier Wand attached to the receiver control unit. At various times during the day and night the Police Department Central Monitoring Unit would call the various offenders homes and the offender would have to physically place the Verifier Wand next to their ankle/wrist transmitter to electronically verify that they were still at home and had not escaped. The On Guard® units were very sophisticated and have an amazing amount of high quality SMD and regular components. Here's what you get when you order the G8150:

- A) One ankle/wrist transmitter unit which is a totally sealed unit that was permanently strapped to your ankle or wrist for the duration of your home arrest time. Inside (if you cut open the 2 5/8" x 2" x 1 5/16" black case) you will find a very sophisticated SMD VHF transmitter board which has 1 SPDT reed switch, 4 SMD ICs, various SMD resistors, capacitors, transistors, diodes, etc. The transmitter is powered by 2 Lithium coin cells enclosed in the second half of the case (the batteries may be dead).
- B) An On Guard® home control/monitor unit which consists of a sophisticated and very sensitive VHF receiver board (has 8 SMD ICs, 3 IF cans, various resistors, capacitors, transistors, etc.), a mother board (as described below), a 6V gel cell, and an external adapter. The box is 8 1/8" x 6 1/4" x 3 1/4" and comes with a screw-in antenna. It also has a keylock on front, 4 LEDs on the front panel. When the offender was taken to his residence, an officer would plug the AC adapter (which is permanently attached to the box) into the wall outlet, and the officer would also insert the phone cable (included) into the phone wall jack. The On Guard® unit received and processed the signal from the ankle transmitter.
- C) A Verifier® wand was plugged into the back of the box. This was another very sophisticated unit. At various intervals throughout the day and night, the central police station computer system would call the offender On Guard® control box. The offender would then need to answer the phone and (in a limited amount of time) place the Verifier® wand over the ankle transmitter (it has a long coiled cord so it would reach the offenders ankle). If this process was not followed, the police would start "looking" for the offender.

Remember, you get all three units as described above, plus the key that the police used to turn the entire unit on and off, all packed in a foam lined cardboard box. These were actual units used in the field and were returned, probably because of some malfunction. So far we have no additional data, and we are selling them "as is" only. We know they don't work! These units must have cost the company a fortune, and from the billing records we saw from late 1994, they were leasing the systems on a "per offender day" basis which was providing a substantial income. These are definitely used, and will have scratches on the cases, a cut or missing transmitter band and will probably be defective in some way. Sold "as is" only with no data available, and we are not selling them to be used for their original purpose. Great for VHF experimenting, researching how home arrest systems worked, etc.

G8150

\$10.00

VIDEO TAPES

These are short (about 5 min.) videos describing different aspects of the home arrest system and the company that produced them. We have three different tapes. Each is informative and in full color.

- "Introduction to Electronic Monitoring" **G8326**
- "The Total Concept Solution" **G8327**
- "Home Arrest Participant Video" **G8153**

YOUR CHOICE \$3.95 ea.

**For Phone Orders Call 800-445-0697
or Fax Your Orders to (602) 661-8259
Customer Service: (602) 451-7454**

Visit us Online at: <http://www.goldmine-elec.com>

Minimum USA and Canada Order: \$10.00 (plus \$5.00 Shipping and Handling). We accept MasterCard, Visa and personal checks, however, we cannot accept personal checks on orders outside the United States.
Minimum Foreign Order Amount: \$50.00 (plus minimum \$10.00 shipping and handling).

ELECTRONIC GOLDMINE
PO Box 5408
Scottsdale, AZ 85261

PHONE ORDERS 800-445-0697

IF YOU CAN'T FIND WHAT YOU ARE LOOKING FOR, CALL FOR OUR LATEST CATALOG #230 CONTAINING OUR ENTIRE PRODUCT LINE OF OVER 4,000 ITEMS. MOST AT BELOW WHOLESALE PRICES!

ELECTROMAGNETIC FIELD (EMF) DETECTOR

This is a complete EMF detector utilizing 3 SMD ICs and 10 bright LEDs that indicate relative strength of EMF energy. Operates on one 9V battery (not included). As soon as you press the on/off button, the unit runs a "self-test" by lighting all 10 LEDs, then it resets itself and indicates the relative EMF strength by the quantity and color of LEDs that light. Size of unit is about 3 5/16" x 2 3/8". These are brand new and prime, but without the outer plastic case. They were made in 1995 and feature some of the latest technology in portable relative EMF detection. We suspect that when the board was installed in the case, the completed unit sold for \$80-\$100 retail, but now you can buy it for a fraction of that price and make your own case (if you wish). We were amazed by the EMF energy emitted even from a small laptop computer within close proximity. We have no data or schematics, but all you need to do is connect a 9V battery and you're in business. Super blowout price!

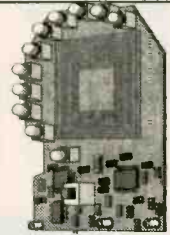

G8317

\$8.95

BARCODE SCANNER WITH WAND

Electronic bar code scanner by Burr-Brown model TM71B or similar. These are about 8 1/2" x 4 3/8" x 1 1/4". They feature a hand-held scanner wand, digital readout, a keyboard and several circuit boards inside the case. We have no specs or data, but we applied 5VDC to it and caused the wand to emit a pulsating red beam and the readouts to light up. They have a DB25 female connector on back. Sold "as is" only-used condition unknown.

G8326

\$14.95

LAMP 3 LEVEL TOUCH CONTROL KIT

These handy kits were made by Leviton to turn any lamp into a touch control lamp that has 3 level dimming. Controls up to 300 watt, 120vac lamps. Small size: 1 3/4" x 1 1/2" x 3/4" control unit is meant to be hidden in the base of the lamp. After installation, simply touch any metal part of lamp or shade, and lamp will turn on at 30%, touch again for 70%, touch again for 100%. A fourth touch turns it off.

G8325

\$4.95

PROFESSIONAL LENS CLEANING TISSUE BOOK

Consists of 50 perforated 4" x 6" lint-free tissues specially made for cleaning precision optics, lenses, microscopes, mirrors, eyeglasses, etc. Made by VWR.

G8324

\$1.95

RADIOSONDE

Very late model Radiosonde made for tracking all types of weather data. These were to be sent aloft attached to a weather balloon (not included). Each is about 10 1/2" long x 3 3/8" thick x 8" wide. Inside of the removable cardboard sleeve is a styrofoam chamber housing a sophisticated 8 IC circuit board which has sensors attached to measure atmospheric pressure, temperature and humidity. As it gathers the information, it transmits the data at about 1.677 GHz (GHz). These are prime, brand new units that were waiting shipment from the manufacturer (Space Data Corporation) to the government when the contract was cancelled. These are complete except for the battery (see below). We connected two 9V batteries in series and the unit worked perfectly from them. Sorry, no schematic available! The main board contains the following ICs: 7555, CD4051, CD4520, LM324, 4151, TLCD27L (2 pcs) and a 78M15C voltage regulator. It also has the precision 105 case pressure sensor, hygistor sensor holder (with the hygistor (humidity) sensor plate in a sealed container ready to insert into the holder), thermistor for temperature measurements and nose cone transmitter antenna assembly. Great for experimentation, building your own weather equipment, studying high frequency transmission, as a source for useful parts or just great for a conversation piece. These cost the government a bundle to have made but we are selling them at a giveaway price. Hurry, get your Radiosonde today!

G5058

\$6.95 • 2/\$12.00

RADIOSONDE (WITHOUT HUMIDITY SENSOR AND BOX)

Complete radiosonde as shown above except these do not have the humidity sensor assembly and the styrofoam container box. These are new units that have the transmitter nose cone, pressure sensor and temperature sensor attached. Simply apply battery power and these will start transmitting data, however they do not have the humidity sensor assembly with humidity sensor plate. Brand new, but no other info.

G5578 \$4.95

WATER ACTIVATED BATTERY IN A CAN

Made for radiosondes these batteries are about 2 1/2" tall x 2" wide x 1 1/2" deep. They were made in 1982 but they have almost an unlimited shelf life because they are not activated until you cut open the can, remove them and immerse in water for 2 minutes. Great for emergencies, earthquakes, camping, collecting weather data with a radiosonde, etc. We activated one of the batteries and conducted a test. We connected a 250k load resistor to the battery and powered the load for 10 hours. Terminal voltage was 20VDC and current flow was 80ma. These do need ventilation as they discharge and should be used outside only. Comes in sealed factory cans. Very unique item!

G8650 \$2.00 ea. • 10/\$15.00 • 100/\$100.00

LIGHTED PUSH ON/PUSH OFF SWITCH

High quality rectangular push on/push off switch that snaps into a 1 1/16" square hole. Contacts are SPST rated, 1 amp 125VAC. Bright green rectangular LED is mounted on clear square top button. LED operates from 5VDC. Size of switch: 1 7/16" L x 3/4" square.

G8328

3/\$1.00 • 10/\$2.50

June 1997, Electronics Now

DIGITAL STORAGE OSCILLOSCOPES

WITH
SPECTRUM
ANALYZER,
DVM, FREQ.
COUNTER,
AND DATA
LOGGER.

from
\$189.

PORTABLE
MODULES
CONVERT PC'S
INTO
MULTIPURPOSE
TEST AND
MEASURING
INSTRUMENTS.

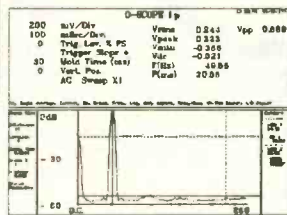
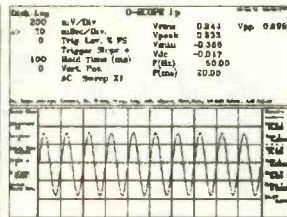

Why lug a scope around? Toss one of our modules into your laptop case or tool kit. For a multi-purpose test device, plug to a PC parallel port and use the PC screen. Continuous, delayed, or triggered sweeps can be frozen on the screen, printed out, or saved to disk. Frequency Spectrums DC to 25 MHz.

Allison now provides PICO TECHNOLOGY Ltd. portable test equipment, including high-speed scopes, and multi channel data loggers. Pico and O-Scope modules accept standard probes and work with 286 or faster PC's.

FEATURES:

- PORTABLE UNITS TO 25 MHz
- USES PRINTER PORT
- USES STD. PROBES

OPTIONS:

- PROBE SETS
- AUTOMOTIVE PROBES
- BATTERY PACKS
- SOFT & HARD CASES

O-Scopes Made in U.S.A. Picos Made in U.K.
Same Day Shipping
Includes Cable, Software & Manuals

O-Scope I/O (DC-50KHz, single trace)\$189.
O-Scope II (DC-500KHz, dual trace)\$349.
PICO (ADC 200/20) (DC-10MHz, dual trace)CALL
PICO (ADC 200/50) (DC-25MHz, dual trace)CALL
PICO pc based data loggers from \$99.

Shipping within U.S. UPS Ground \$7.50(Second day \$11.50)

SEND CREDIT CARD INFO., M.O., or CHECK, OR CALL

1-800-980-9806

Allison Technology Corporation

8343 CARVEL, HOUSTON, TX. 77036 U.S.A.

PHONE: 713-777-0401 FAX: 713-777-4746 BBS: 713-777-4753

<http://www.atcweb.com>

WORLD'S SMALLEST UHF X-tal Locked Video Transmitters \$99.00

So small the transmitter, camera and battery will fit into a cigarette pack!!!

Used by hundreds in covert CCTV, R/C models, movie Special Effects, and Law Enforcement. "I've utilized your transmitters in covert video installations for about one year... previously, I used costly wireless units from Pelco, MVP, and Supercircuits. Nothing approaches the VidLink in terms of power, picture quality, size, and value. Thank you!"
R. Leslie, CCTV Installer, NY.
"Incredible color, resolution... easy to use, convenient. Very cool!" P. Davis, Props, CA.
"... like having a TV station in your pocket."
J. Ramsay, Electronic Hobbyist FL.

LIVE REMOTE VIDEO FROM: **\$99.00** ACTUAL SIZE!!!

VidLink 100: 100mW Power- Up to 1/4 Mile
\$199.00 New! High-Power!

VidLink 15: 15mW Power- up to 150 Feet
\$99.00 New! Low Price- Same Size!

Covert Camera: 1 1/4" sc. Pinhole Lens
\$169.00 Pro Grade Japanese Quality!

*** Audio Module Now Available. Call.***

Check/MO, COD +\$5.00, S&H \$5.50



AEGIS RESEARCH

#371-1225 E. Sunset Dr
Bellingham, WA
93226-3529 USA

1-604-224-0416

Visit our virtual catalog on the INTERNET at:
<http://www.lynx.bc.ca/virtualspy>

CONTROL RELAYS • LIGHTS • MOTORS MEASURE TEMPERATURE • PRESSURE • LIGHT LEVELS • HUMIDITY INPUT SWITCH POSITIONS • THERMOSTATS • LIQUID LEVELS

MODEL 30 \$79



- PLUGS INTO PC BUS
- 24 LINES DIGITAL I/O
- 8 CHANNEL
- 8 BIT A/D IN
- 12 BIT COUNTER
- UP TO 14K SMP/SEC

MODEL 45 \$189



- RS-232 INTERFACE
- 8 DIGITAL I/O
- 8 ANALOG INPUTS
- 2 ANALOG OUTPUTS
- 2 COUNTERS-24 BIT

MODEL 100 \$279



- 12 BIT 100 KHZ A/D
- 4 ANALOG OUTPUTS
- 3 TIMER COUNTERS
- 24 DIGITAL I/O

MODEL 60 \$179

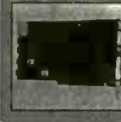

- 8 2-AMP RELAYS
- 16 DIGITAL I/O
- 1 6-BIT ANALOG INPUT

MODEL 40 \$139



- RS-232 INTERFACE
- 28 LINES DIGITAL I/O
- 8 ANALOG INPUTS
- PWM OUTPUT
- OPTIONAL 12 BIT A/D

MODEL 70 \$239



- RS-232 INTERFACE
- 18 BIT A/D
- 8 5-DIGIT
- UP TO 60 SMP/SEC

NEED A CUSTOM PCB? TRY US.

PRAIRIE DIGITAL, INC.

PHONE 608-643-8599 • FAX 608-643-6754

920 SEVENTEENTH STREET • PRAIRIE DU LOU, WISCONSIN 53578



NU-TEK
ELECTRONICS
Leading the way to excellence

Open 24 hours

Call for your **FREE** catalog or we are on the Internet at <http://www.nutek-usa.com>

Go to the **SOURCE** for **Price, Quality & Quantity**

If you are considering the Infinity 3000, the Navigator or the Navigator II you need to call us!

Infinity 3000

Qty	Price/unit
1	\$299.95*
2	\$289.95*
3	\$279.95*
4	\$269.95*
5	\$259.95*



FCC & U.L. Approved

- Upgradeable Descrambler Micro Card
- 125 Channel Capacity (1-125)
- Sleep Timer
- Advanced Parental Control
- Audio/Video Ports
- Volume Control/Mute
- Favorite Channel Memory

Stargate **NAVIGATOR**

Qty	Price/unit
1	\$349.95*
2	\$339.95*
3	\$329.95*
4	\$319.95*
5	\$309.95*



FCC & U.L. Approved

- Upgradeable Descrambler Micro Card
- 125 Channel Capacity (1-125)
- Advanced Parental Control
- Audio/Video Inputs and Outputs
- 4 Favorite Channel Memory Buttons
- Interactive On-Screen Display System
- Electronic Program Guide Upgradeable
- Sleep Timer
- Last Channel Recall
- Time Clock, Preloaded Channel Label
- One Step Bypass Capabiity

*Prices do not include Base Band Models

Now available - Navigator II
Includes: 2 Tuner 2 Descrambler Option

NU-TEK offers **REPAIR SERVICES** for all brands of cable converters & descramblers. Call (512) 250-5031 and press 4 for our technical support department.



1-800-616-8835



CIRCLE 336 ON FREE INFORMATION CARD

www.americanradiohistory.com

CALL TOLL FREE
(800) 292-7711 orders only
Se Habla Español

C&S SALES
EXCELLENCE IN SERVICE

CALL OR WRITE FOR
A FREE 60 PAGE
CATALOG!
(800) 445-3201

XK-550 Digital / Analog Trainer

Elenco's advanced designed Digital / Analog Trainer is specially designed for school projects. It is built on a single PC board for maximum reliability. It includes 5 built-in power supplies, a function generator with continuously sine, triangular and square wave forms. 1560 tie point breadboard area.

XK-550
Assembled and Tested
\$169.95

XK-550K - Kit
\$139.95

Tools and meter shown optional



TK-3000
\$89.95

Tools Included:

- SR-2 - Deluxe Soldering Iron
- SH-1 - Soldering Iron Stand
- ST-1 - Diagonal Pliers
- ST-2 - Long Nose Pliers
- ST-30 - Deluxa Wire Stripper
- SE-1 - Solder Ease Kit
- ND-3 - 3 pc. Nut Driver Set
- TL-8 - Precision Screw Drivers
- ST-5 - Screw Driver Slotted 3/16"
- ST-6 - Screw Driver #1 Phillips
- ET-10 - IC PuBer
- SP-2 - Solder Pump
- ST-20 - Safety Goggles
- ST-9 - Pocket Screw Driver
- ST-4 - Solder Tube
- SW-3 - Solder Wick



A professional technician service tool kit in a metal reinforced tool case with heavy-duty handle and locks. A removable pallet handles most of the tools listed with more room for tools and parts in the lower half.

GF-8026 w/ Frequency

- Linear and Log Sweep
- .02Hz to 2MHz
- Counter Range 1Hz to 10MHz
- 4 Digit Display

\$225



MX-9300 Four Functions in One

- One instrument with four test and measuring systems:
 1.3GHz Frequency Counter • 2MHz Sweep Function Generator
 Digital Multimeter • Digital Triple Power Supply
 (0-30V @ 3A, 15V @ 1A, 5V @ 2A)

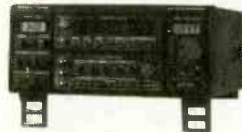

\$479.95

Model XP-581

4 Fully Regulated DC Power Supplies in One Unit
 4 DC voltages: 3 fixed - +5V @ 3A, +12V @ 1A, -12V @ 1A
 1 Variable - 2.5 - 20V @ 2A

\$85



Auto Ranging Hand-Held DMM w/ Bar Graph
Model EDM-163

\$99.95

7 Functions with data hold
 Compares to Fluke Model 77II

Digital Multimeter
Model M-1700

\$39.95

11 functions including freq to 20MHz,
 cap to 20µF. Meets UL-1244 safety specs.



Fluke Multimeters

70 Series

- Model 70II\$69.95
- Model 73II\$97.50
- Model 75II\$135.00
- Model 77II\$154.95
- Model 79II\$175.00

80 Series

- Model 83\$235.00
- Model 85\$269.00
- Model 87\$289.00

B&K Precision Multimeters

- Model 391\$159.00
- Model 390\$139.00
- Model 389\$109.00
- Model 388A\$99.00
- Model 2707\$79.00
- Model 2860A\$85.00

Kit Corner

over 100 kits available

PT-223K

\$15.95

Phone kit with training course.



Fiber Optics Technology
 with training course
Model FO-30K

\$19.95



Model AM/FM-108K
Transistor Radio Kit

with training course

\$29.95

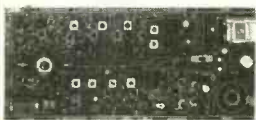

M-1005K
Compact Multimeter Kit

\$19.95

6 Functions & Transistor Test



Model M-6100

Programmable DMM
 Includes **FREE** Computer Interface and **FREE** Software

- Analog Bar Graph
- Large 3 3/4" LCD Display
- Menu Driven
- Triple Display
- RS-232 Interface
- True RMS
- 9 Basic Functions including cap. & freq.
- Auto Power Off
- Easy-to-use

\$125



WE WILL NOT BE UNDERSOLD

C&S SALES, INC.

UPS SHIPPING: 48 STATES 5%
 OTHERS CALL FOR DETAILS
 IL Residents add 8% Sales Tax

150 W. CARPENTER AVENUE
 WHEELING, IL 60090
 FAX: (847) 541-9904 (847) 541-0710
http://www.elenco.com/cs_sales



15 DAY MONEY BACK GUARANTEE

FULL FACTORY WARRANTY

PRICES SUBJECT TO CHANGE WITHOUT NOTICE

CIRCLE 329 ON FREE INFORMATION CARD

**FREE PROBES
WITH ALL
SCOPES**

OSCILLOSCOPES

Lowest Prices of the Year!

**CALL OR WRITE FOR
A FREE 60 PAGE
CATALOG!
(800) 445-3201**

B&K Precision Scopes

60MHz ANALOG WITH DIGITAL STORAGE

Model 2560
• Cursors and readouts
• RS-232 port
• 20MS/s real time sampling
• 1GHz equivalent time sampling (at 0.1µs/div)
• Prints via RS-232 port to any HP-GL plotter
\$1995

20MHz ANALOG WITH DIGITAL STORAGE

Model 2522A
• 20MHz analog bandwidth
• 20MS/s sampling rate
• 2K memory per channel
• 300MHz equivalent time sampling
• Pre-trigger capture
\$869.95

100MHz THREE-TRACE

Model 2190A
• 1mV/division sensitivity
• Sweeps to 5ns/division
• Dual time base
• Signal delay line
• 15KV accelerating voltage
\$1379.95

60MHz DUAL-TRACE

Model 2160A
• 1mV/division sensitivity
• Sweeps to 5ns/division
• Dual time base
• Signal delay line
• V-mode-displays two signals unrelated in frequency
• Component tester
\$949.95

40MHz DUAL-TRACE

Model 1541C
• 1mV/division sensitivity
• Video sync separators
• Z-axis input
• Single sweep
• V mode displays two signals unrelated in frequency
• Component tester
\$695

60MHz, CURSORS & READOUTS, DUAL TIME BASE

Model 2260
• Cursors and readouts
• 1mV/div sensitivity
• 23 calibrated ranges - main time base
• 19 calibrated ranges - delayed time base
• Signal delay time
• V-mode - displays 2 signals unrelated in frequency
• Component tester
• Z-axis input
• Single sweep
\$1225

20MHz DUAL-TRACE

**Model 2120 - 2 Year Warranty
Special \$389.95**

Model 2125 with delayed sweep

\$539.95
• 1mV/division sensitivity
• AUTOCORRECT triggered sweep operation
• AC, TVH, TVV and line coupling
• Calibrated 19 step time-base with x10 magnifier
• Compact low-profile design

Affordable Spectrum Analyzers by B&K

500MHz Series
Model 2615 - \$1595
Model 2620 w/ tracking generator - \$1895

1.05GHz Series
Model 2625 - \$2395
Model 2630 w/ tracking generator - \$2995

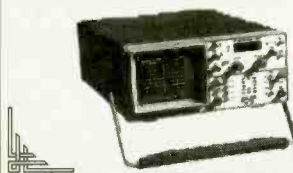

WE WILL NOT BE UNDERSOLD
UPS SHIPPING: 48 STATES 5%
OTHERS CALL FOR DETAILS
IL Residents Add 8% Tax

Quality Scopes by Elenco



60MHz

DS-603 \$1350

- Analog / Digital Storage
- 20MS/s Sampling Rate

S-1360 \$749

- Analog with Delayed Sweep

40MHz

S-1345 \$569

- Analog with Delayed Sweep

S-1340 \$475

- Analog

25/30MHz

DS-303 \$1095

- Analog / Digital Storage

S-1330 \$439

- 25MHz Analog
- Delayed Sweep

S-1325 \$325

- 25MHz Analog

**2 Year
Warranty**

OSCILLOSCOPE SELECTION CHART

ANALOG		Sensitivity	No. of Channels	Sweep Rate	Delayed Sweep	Video Sync	Component Tester	Beam Find	Time Base
Model	Bandwidth MHz								
S-1360	60	1mV/div	2	10ns/div	Yes	Yes	Yes	Yes	2
S-1345	40	1mV/div	2	10ns/div	Yes	Yes	Yes	Yes	2
S-1340	40	1mV/div	2	10ns/div	No	Yes	No	No	1
S-1330	25	1mV/div	2	10ns/div	Yes	Yes	Yes	Yes	2
S-1325	25	1mV/div	2	10ns/div	No	Yes	No	No	1
DIGITAL STORAGE		Analog Sen (max)	No. of Channels	Sampling Rate	Memory Channel	Internally Backed Up	Pretrigger %	Output	
Model	Bandwidth MHz								
DS-303	30	1mV/div	2	20MS/S	2K	Yes	0, 25, 50, 75	RS232	
DS-603	60	1mV/div	2	20MS/S	2K	Yes	0, 25, 50, 75	RS232	

HURRY... AT PRICES THIS LOW THEY'LL BE GONE FAST!

HITACHI SCOPES

**Inventory Reduction Sale
Lowest Prices of the Decade!**

V-209 - 20MHz Battery Operated Was \$1595, NOW \$1095 Save \$410

V-695 - 60MHz w/ Cursors Was \$1815, NOW \$1395 Save \$420

V-422 - 40MHz Was \$965, NOW \$765 Save \$200

V-1065A - 100MHz w/ Cursors Was \$2139, NOW \$1565 Save \$574

V-525 - 10MHz w/ Cursors Was \$1355, NOW \$955 Save \$400

V-1560 - 100MHz Was \$1790, NOW \$1490 Save \$300

V-552 - 50MHz Was \$1195, NOW \$850 Save \$345

V-1565 - 100MHz w/ Cursors Was \$1960, NOW \$1595 Save \$365

V-555 - 50MHz w/ Cursors Was \$1375, NOW \$975 Save \$400

V-252 - 20MHz **\$419**

Fluke Scopemeters



91 \$1225
92B \$1445
96B \$1695
97 \$1795
97A \$2945
99B \$2095

Call or write for complete specs.

C&S SALES, INC.

150 W. CARPENTER AVENUE
WHEELING, IL 60090
FAX: (847) 520-9904 (847) 541-0710
http://www.elenco.com/cs_sales/



**15 DAY MONEY BACK
GUARANTEE
FULL FACTORY WARRANTY**
PRICES SUBJECT TO CHANGE WITHOUT NOTICE

CIRCLE 329 ON FREE INFORMATION CARD

Learn by Example!

The PRIMER 8085 Based Microprocessor Training and Control System shows you how to program by example. Examples & exercises in the Self Instruction manual take you from writing simple programs to controlling motors. Start out in Machine language, then move on to Assembler, & then continue on with optional C, Basic, or Forth Compilers. This trainer can be used stand alone via the keypad and display or connected to a PC with the optional upgrade (\$49.95). The Upgrade includes: an RS232 serial port & cable, 32K of battery backed RAM, & Assembler/Terminal software.

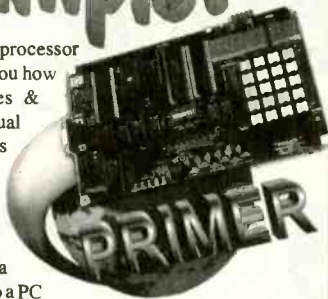

- Examples Include:**
- Measuring Temperature
 - Using a Photocell to Detect Light Levels
 - Making a Waveform Generator
 - Constructing a Capacitance Meter
 - Motor Speed Control Using Back EMF
 - Interfacing and Controlling Stepper Motors
 - Scanning Keypads and Writing to LCD/LED Displays
 - Bus Interfacing an 8255 PPI (new)
 - Using the Primer as an EPROM Programmer

The PRIMER is only \$119.95 in kit form. The PRIMER Assembled & Tested is \$169.95. Please add \$5.00 for shipping within the U.S. Picture shown with upgrade option and optional heavy-duty keypad (\$29.95) installed.

EMAC, inc.
 11 EMAC WAY, CARBONDALE, IL 62901
 618-529-4525 Fax 457-0110 BBS 529-5708
 World Wide Web: <http://www.emacinc.com>

1985 - 1997
 OVER
12
 YEARS
 OF SERVICE

From MILLIWATTS to KILOWATTS

RF POWER TRANSISTORS • TUBES POWER MODULES



Best pricing on U.S. & Russian



Transmitting & Receiving Tubes

3-500ZG • 811A • 833A • 572B
 4-400C • 6146B & W • 8560AS • 8875 • 3CX400A7 & U7
 3CX1200A7 & Z7 • 3CX1500A7 • 3CX3000A7 • 4CX250B & R
 4CX400A • 4CX800A • 4CX1600A & U • 5CX1500A & B
 including full range through 4CX20,000A



Complete inventory for servicing
 amateur and commercial
 communications equipment.

Transistors • RF Modules • Trimmers
 Doorknob Capacitors • Heatsinks
 Bird Wattmeters • Relays
 Broadband Transformers & Combiners

**MOTOROLA
 TOSHIBA**



Send for your **FREE 1997 Catalog**
 Same Day Shipping on most orders.



800 RF-PARTS • 760-744-0700
 Fax: 888-744-1943 • 760-744-1943
 e-mail: rpf@rfparts.com



RF PARTS

435 SOUTH PACIFIC STREET
 SAN MARCOS, CA 92069

❖ ATTENTION CABLE VIEWERS ❖

CABLE VIEWERS. . .get back to your BASIC Cable Needs

Call 800-577-8775

For information regarding all of your **BASIC** cable needs.



5 GOOD REASONS TO BUY OUR FAR SUPERIOR PRODUCT

- ❖ **PRICE**
- ❖ **EFFICIENT SALES AND SERVICE**
- ❖ **WE SPECIALIZE IN 5, 10 LOT PRICING**
- ❖ **ALL FUNCTIONS (COMPATIBLE WITH ALL MAJOR BRANDS)**
- ❖ **ANY SIZE ORDER FILLED WITH SAME DAY SHIPPING**

We handle **NEW** equipment **ONLY** - Don't trust last year's **OBSOLETE** and **UNSOLD** stock!
COMPETITIVE PRICING—DEALERS WELCOME

HOURS: Monday-Saturday 9-5 C.S.T.

It is not the intent of B.E.S.W. to defraud any pay television operator and we will not assist any company or individual in doing the same. Refer to sales personnel for specifications.

**BASIC
 ELECTRICAL
 SUPPLY &
 WAREHOUSING
 CORPORATION**

P.O. Box 8180 ■ Bartlett, IL 60103 ■ 800-577-8775

SEC Sun Equipment Corporation

P. O. Box 97903, Raleigh, NC 276 24-7903

Test Equipment for Cost-Minded People

LODESTAR Lodestar Electronics Corp. Since 1979

One Year Warranty. 15 Day Money Back Guarantee. OEM welcome. School purchase order accepted. Bids accepted. VISA, DISCOVER SALES REP/DISTRIBUTORS/OEM WANTED. MASTER, & AMER. 1-800-870-1955/(919)870-1955 24-hr Fax:(919)870-5720

DC POWER SUPPLY

PS-303 \$159.00
0-30VDC, 0-3A, 0.02%+2mV line regulation, 0.02%+3mV load regulation, 1mVrms noise & ripple; Short circuit/overload protection; constant current/voltage(CCCV).
PS-303D \$314.95 dual output, tracking
PS-305 \$219.95, 0-30VDC, 0-5A.

PS-305D \$399.95, dual, tracking
#112 \$289.95 0-60VDC, 0-3A
#112 \$399.95 0-60VDC, 0-5A
#108(#109) \$549.95(\$699.95) 0-60VDC, 0-3A(5A), dual, independent tracking. Low ripple.
#102(#103) \$399.95(\$489.95) triple outputs, 0-30V/0-3A(5A) x 2, fixed 5VDC/3A, independent & tracking operation, constant voltage and current. Slave/Master. Serial/Parallel connection.
PS-1610S(#107) \$289.00(\$399.95) 0-16VDC(0-30VDC), 0-10A.
PS-2243(2245) \$139.00(\$159.00) 0-12/0-24VDC, 3A(5A).
#2000(#201) \$179.95(\$239.95) 0-30VDC(digital meter), 0-3A(5A).
#2100(#211) \$199.95(\$259.95) two digital meters.
#202(#203) \$499.95(\$549.95) 3 outputs, digital display, dual 0-30VDC/0-3A(5A), a fixed 5VDC/3A, independent tracking operation, constant voltage and current.

AM/FM SWEEMAR SCOPE

SM-6225B/C \$1999.95
Freq Range: (AM)490KHz, (FM) 10-11.4MHz, Accuracy ± 0.1%
Marker: (AM)455KHz, ±5KHz, ±10KHz, (FM)10.7MHz, ±7.5KHz, ±150KHz

STEREO SCOPE OS-7505B \$369.00 trigger, 0-10MHz.

ALIGNMENT SCOPE OS-7001A \$369.00 0-200KHz.

AM/FM STD SIGNAL GEN.

SG-4110A \$1799.00
Freq: 100KHz-110MHz
Display: 6-digit LED
Accuracy: $\leq (5 \times 10^{-E5} \pm 1 \text{ count})$
Resolution: 100Hz (100-34.99MHz); 1KHz (35MHz-110MHz).
Output: -19dBu, -99dBu, 1dB steps. **Impedance:** 50Ω VSWR 1.2

NTSC TV COLOR BAR PAT. GEN.

CPG-1366A \$159.95
VHF NTSC;
Freq: 45.75, 175.25, 187.25 MHz,
RF Output: 10mV.
Impedance: 75 Ohm;
Video Output: BNC, 1Vp-p

SWR/RF/mW POWER METER

310 \$89.95
Freq Range: 1.8-150MHz
RF Power: 0-4W/20W/200W
SWR Measure: 1.0 - ∞, 4W min.
Accuracy: 5%-10%; SO-239 plugs.
Insertion Loss: 0.3dB.

Input/Output Imp: 50Ω
320 \$89.95, 130-520MHz
330 \$119.95, 1.8-520MHz
SWR-3P \$26.95 1.7-150MHz,
RF Power: 0.5-10W, 0.5W-100W
SWR-2P \$22.95, 1.7-30MHz; **RF Power:** 0.5-10W.

mW RF Power Meter 340 \$219.00
1.8-500MHz, RF power: 20mW/200mW/2W; Imp: 50Ω;
Accuracy: ±10% full scale; N-type connector; SWR <math>< 1.15</math>.

VHF/UHF ATTENUATORS

RT-8815 \$199.00, VHF, 500MHz, 81dB, 50Ω, 0.5W
RT-8815U \$359.00, UHF, 950MHz, 81dB, 50Ω, 0.5W
RT-8817 \$199.00, VHF, 500MHz, 81dB, 75Ω, 0.5W.
RT-8817U \$359.00, UHF, 950MHz, 81dB, 75Ω, 0.5W
085E-2 \$499.00, UHF, 950MHz, 61dB, 50Ω, 0.5W.
087E-2 \$499.00, UHF, 950MHz, 61dB, 75Ω, 0.5W

SALES - DC Power Supply

#102 \$399.95 \$359.95 triple outputs, 0-30V/0-3A x 2, fixed 5VDC/3A, independent & tracking operation, constant voltage (CV) & constant current (CC), Slave/Master, Serial/Parallel connection.
PS-303D \$314.95 \$282.95 dual outputs/tracking, CC&CV. **Limited quantity. Full one year warranty.**

RF SIGNAL GENERATOR

SG-4160B \$124.95
100KHz-150MHz up to 450MHz on 3rd harmonics; 6 ranges; AM modulation. **RF Output:** 100mVrms to 3-5MHz. **Modulation:** Int. 1KHz AM, Ext. 50Hz-20KHz AM.
Audio Output: 1KHz, 1Vrms.

SG-4162AD \$229.95, with Freq. Counter 1Hz-150MHz, 6 digits, for internal & external signals. Specification see SG-4160B above.

AUDIO GENERATOR

AG-2601A \$124.95
10Hz-1MHz, 5 ranges;
Output Level: sinewave 0-8Vrms, square 10Vp-p.
Output Impedance: 600 Ohm.
Distortion: <math>< 0.05\%</math> 500Hz-50KHz, <math>< 0.5\%</math> 50KHz-500KHz.

AG-2603AD \$229.95, with Freq. Counter 1Hz-150MHz, 6 digits, for internal & external signals. Specification see AG-2601A above.

FUNCTION GENERATOR

FG-2100A \$169.95
0.2Hz-2MHz in 7 ranges, Sine, Square, Triangle, Pulse & Ramp
Output: 5mVp-p-20Vp-p, 1% distortion
VCF: 0-10V control freq. to 10001.

FG-2102AD \$229.95 generates signals same as FG-2100; 4-digit counter display. TTL & CMOS outputs, 30ppm ± 1 count accuracy

FG-2020B \$159.00 0.5Hz-500KHz, Sine, Square, Triangle.

(FG)2103 \$329.95, Digital sweep generator, 0.5Hz-5MHz in 7 ranges. **Operating Mode:** sweep, AM, gated burst, VCG.

Freq. Counter: Int. 0.5Hz-5MHz; Ext. 5Hz-10MHz

FG-513 \$719.95, Digital sweep generator; Sine, Square, Triangle, Pulse, Ramp, TTL & DC, 2Hz-13MHz in 7 ranges, ±(0.1%+1dig).

Freq. Counter & TCXO: 5Hz-100MHz, 5.5 digits. x1 & x20 attn.

FM STEREO MODULATOR

AG-2011A \$549.00
RF SECTION:
Carrier: 98MHz ±2MHz,
Output: 10mV, 1mV & 0.1mV
COMPOSITE SIGNALS:
Pilot: 19KHz ±2Hz, 0.8Vrms
INT. MODULATION: 400KHz, 1KHz ±1%, 1Vrms, distortion <math>< 5\%</math> L-R Separation: >50dB.
EXT. MODULATION: **Freq:** 50Hz-15KHz
L-R Separation: >45dB 100Hz-3KHz; >35dB 50Hz-15KHz.

AC MILLIVOLT METER

MV-3100A \$159.95 wide band 5Hz-1MHz, 3 scales, mV, dB & dBm, 300μV-100V in 12 ranges, 10μV resolution, -70-40dB in 12 ranges, 0dB=1Vrms, 0dBm=0.755V; ±3% accuracy; Input impedance 10MΩ; Noise <math>< 2\%</math>. **MV-3201B \$309.95** dual channels, simultaneous measurement.

OSCILLOSCOPE OS-7305B \$249.00 DC-7MHz;
Vertical: 10mV/Div, Horizontal: 250mV/Div, 10Hz-100KHz in 4 ranges; 3" CRT; Internal and External Sync.; Input: 1MΩ/35pF.
OS-7010A \$369.00 \$299.95 10MHz 5" CRT, 10mV/Cm-10V/Cm, 1MΩ
OS-622B \$344.95 20MHz/dual trace

OS-653 \$699.95 50MHz, dual, delay sweep, ALT trigger, TV syn.

OS-6100B \$1329.95 100MHz, 4ch, 8 traces, delay sweep, best buy

DIGITAL MULTIMETER

DMM-120 \$24.95, 3½ digit, 600VDC/AC, 2ADC, 2MΩ, hFE/diode test.
DMM-123+Capacitance \$44.95, 3½ digit, 600VDC/AC, 10ADC/AC, 2GΩ, 20μF, hFE/diode test, continuity beeper.
DMM-125 \$54.95, Autorange/Bar Graph, 600VDC/AC, 2ADC/AC, 32MΩ, continuity beeper.
MIC-35 \$59.95, Autorange, 3½ digit, LCD, 1000VDC/750VAC, 20MΩ, 20ADC/AC, diode/continuity check, data hold.
MIC-39 \$149.95, Autorange/Bar Graph, True RMS, 3½ digit, LCD, 40MΩ, 40μF, 1000VDC/750VAC, 20ADC/AC, 600KHz Freq. Counter, Data Hold, Drop-prove, Sleeping Mode, Memory & Read Functions

GRID DIP METER

DM-4061 \$89.95 1.5-250MHz, 6 bands; 6 plug-in coils, 2 transistor, and 1 diode.
Modulation: 2KHz Sinewave. **Crystal Oscillator:** 1-15MHz. Wave absorption meter. Using 9VDC power supply.

AUTO DISTORTION METER

DM-3104A \$799.95
MEASUREMENT:
Range: 0.01%-30%, 0.1/0.3/1/3/10/30% full scale.
Freq.: 400Hz±10%, 1000Hz±10%(HPF).
Input: 3mV-100V, ratio measuring 20dB.
Auto. Switching Ranges: Fundamental Freq. = (fo)±10%; **Fund. Rejection:** >80dB at (fo)±5%, >70dB at (fo)±10%.
Harmonic Accuracy: ±0.5dB, 1.8(fo)-20KHz.
DM-3204 \$1,599.00 dual channels.

FREQUENCY COUNTER

FC-5250C \$119.95
Freq Range: 10Hz-220MHz (HF) 10Hz-20MHz, (VHF) 10MHz-200MHz
Gate Time: 0.1 & 1sec.
Max Input: 10Vp-p.
Input Sensitivity: 35mV 10Hz-200MHz. **Display:** 7-digit LEDs.
Input Imped: (HF) 1MΩhm, (VHF) 50Ωhm.

FC-5260A \$946.00 \$129.95 10Hz-600MHz 7-digit LEDs.

FC-5270 \$149.95 10Hz-1.2GHz 8-digit LEDs.

FC-5600B \$921.00 \$299.95 10Hz-600MHz 10-digit LEDs.

(FC)5700 \$329.95 10Hz-1.3GHz, 10-digit LEDs.

SIGNAL TRACER/INJECTOR

SE-6100 \$134.95
TRACER: Gain Max. 60dB
Attenuation: 0/20/40/60dB
Input Imped: 100KΩhm
Output Imped: 600Ωhm,
Speaker: 8 Ohm
INJECTOR: Freq: 1KHz
Squarewave: **Output Level:** Continuously variable 0-4.5Vp-p.

AUTO. CAPACITANCE METER

CM3300A \$139.00 10 ranges, 99.9pF - 99.9mF, fully automatic
Resolution: 0.1pF lowest, 0.1% full scale.
Accuracy: 0.5% of full scale; 1 digit to 99.9μF, 1% of full scale; 1 digit to 99.9μF.
Display: 3 digit LED
Unit indicator: pF, nF, μF, mF. Overrange indicator.

WOW-FLUTTER METER

WF-3103A \$699.95
Freq. Range: 3KHz±10%
JIS/CCIR: 3.15KHz±10% DIN.
Range: 0.03/1/3/3% full scale.
Accuracy: ±5%
WF-3105A \$799.95, digital;
Function: LIN/WOW/Flutter/WTD.
Freq Cntr: 10Hz-9.99MHz.
Indication: CCIR/DIN/JIS.

MICROPROCESSOR TRAINER

8088 Trainer \$699.00 BGC-8088, teach yourself 8088 assembly language programming. Assembly language coding, assembler, disassembler, single step and multi-breakpoint program debugger, display and rewrite registers, download/upload programs from/to external systems, I/O drivers, 56-key large size keyboard, LCD display, RS-232, UART, printer interface, two expansion slots, ±5V, ±12V switching power supply, 20 I/O applications available, e.g. servo & stepping motors, dot matrix display, D/A, A/D, sensors, etc. Learning Guide included.
8051/8052 Embedded Microcontroller \$979.00 BGC-8052, teach yourself Intel 8051/8052 Microcontroller controls. 8051/8052 is one of the most popular Microcontroller used in today's appliance controls and is compatible with the new powerful MCS 251. Step-by-Step Learning Guide included.
CIC-100 \$549.00 I/O control applications, learn Assembly, C, and BASIC programming languages, 800-pin solderless bread-board for circuit design and test. I/O drivers for controlling relay, step motor, LED, speaker, sensor, etc. Application control modules available.

CIRCLE 327 ON FREE INFORMATION CARD



- PRODUCT ENGINEERING
- FIRMWARE DEVELOPMENT

"QUALITY IS OUR CAPITAL CONCERN."

**Complete On Site
Electrical Engineering Lab**

- REVERSE ENGINEERING
- RF CIRCUIT DESIGN & MANUFACTURING

- MICRO CONTROLLER & EPROM HARDWARE & SOFTWARE DEVELOPMENT

From Auto-Routing to CNC Routing to Electronic Assemblies...
Capital Electronics is Your Best Route For Printed Circuit Boards.

DESIGN/LAYOUT

- CAD LAYOUT SERVICES
- COMPATIBLE WITH ALMOST ALL CAD SYSTEMS
- FROM SCHEMATICS OR SAMPLE PCB'S
- PHOTOPLOTTING SERVICES
- 28,800 BAUDE MODEM

PRINTED CIRCUIT BOARDS

- SINGLE & DOUBLE SIDED
- MULTI-LAYER & FLEXIBLE PCB'S
- FROM QUICK TURN PROTOYPES TO SCHEDULED PRODUCTION RUNS
- FINE LINES, SMT
- ELECTRICAL TESTING
- PRECIOUS METAL PLATING

ASSEMBLY SERVICES

- FAST TURN BOARD STUFFING
- WIRE HARNESSES
- WAVE SOLDERING
- ACQUISITION OF PARTS
- FINAL TESTING
- TURNKEY SERVICES
- CUSTOM ENCLOSURES

*For Quick & Competitive Pricing or More Information,
Please Call Us Today!*

303 Sherman Street • Ackley, Iowa 50601

(515) 847-3888

Fax (515) 847-3889 • Modem (515) 847-3890



Internet Access:

For Automated Info Response:
INFO@capital-elec.com

E-Mail: Quote@capital-elec.com

Web Access: <http://www.capital-elec.com>

CIRCLE 311 ON FREE INFORMATION CARD

The Hacker's Companion CD-ROM

ALL NEW FOR 1997!!

Are you interested in using the internet in ways you never dreamed possible? Want a war-dialer program or something to crack a password? Do you want to learn how the phone company gets ripped off, or learn how to build a red box, or modify a cellular phone? Want to see what the security holes in Windows NT are? Or how to compromise a Unix machine or a BBS? Want to learn how to use the system in ways you never imagined possible? This CD is the place to look! It contains all kinds of computer, telephone and general hacking information. Even a video of dutch hackers breaking into a classified US military computer! **In all, over 600 megabytes of fascinating information that's hard to get anywhere else!**

PC-Compatible CD-ROM \$29.95 Shipping \$3

Call (800)719-4957 now!

to order (Visa/MC/COD) or call or write for **FREE CATALOG** of hard-to-get information about *computer viruses, computer hacking, security and cryptography!!*

American Eagle Publications, Inc.
P. O Box 1507
Show Low, AZ 85901

CIRCLE 322 ON FREE INFORMATION CARD

WHITE-STAR ELECTRONICS

TEL: 405-631-5153 FAX: 405-631-4788

CONVERTERS:	20	50	100+
Regal CR-83	45	39	35
* New, Panasonic TZPC 145	75	69	65
DQN-5 (2 or 3) (unmodified)	45	39	35
DRZ-3 PJ (unmodified) 70 Channel Plain	35	32	29
DRX-3 PJ (unmodified) 60 Channel Plain	32	30	27

Call for **FREE** catalog.
405-631-5153



REMOTE CONTROL

HAND UNITS:	20	50	100+
Jerrold Replaces: 400/450/550	4.95	4.50	4.25
Scientific Atlanta: 075/175/475	4.95	4.50	4.25
8600: On screen display	7.50	7.00	6.50
Pioneer: BR 81, 82	4.95	4.50	4.25
Panasonic: Call for model #	7.50	7.00	6.50
Zenith: All	4.95	4.50	4.25
Tocom: 5503-VIP, 5503-A	7.00	6.50	6.25
Universal: 4 in 1 R/M	7.50	7.00	6.50

Call for Oak, Hamlin, Regal-83, Regency, Texscan, and all others.

Tamper-Bit tools: (10-lot)

Jerrold compatible bits:	
1/4" Stacom Bit	\$8.00
Oval Round D	\$20.00
Torx Bit:	
Tocom T-8	\$8.00
Zenith T-10, T-15	\$8.00
Pioneer T-20	\$8.00
Scientific Atlanta T-20	\$8.00
Pio 63XX Oval	\$20.00
Bit Driver Handle	\$4.00

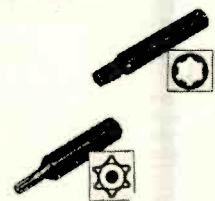

We carry most remote hand units. If you don't find the one you're looking for, we can locate for you.

Specializing in large quantities.

HOURS: Monday thru Friday 9 am to 5 pm Central Time.

Call for **FREE** catalog.

CIRCLE 318 ON FREE INFORMATION CARD

DO-IT-YOURSELF AUDIO AMPLIFIER KITS

Mark V Electronics, Inc.
8019 E. Slauson Ave.,
Montebello, CA 90640

In business since 1985

Mention AD
& take 10% off
your 1st order!

Enclosures at Unbeatable prices!
New educational kits for learning and more fun!
Free Catalog 213/888-8988 Fax 213/888-6868
Order 1-800-521-MARK / 1-800-423-FIVE

Kit skill levels are specified as ▲ beginner ▲▲ intermediate or ▲▲▲ advanced!

Best Buy Metal Cabinets with Aluminum Front Panel



LG-1273 3x12x7" \$ 26.50
LG-1684 4x16x8" 32.50
LG-1924 4x19x11 1/2" 38.25
LG-1925 5x19x11 1/2" 42.00
LG-1983 2 1/4 x19x8" 35.25
LG-1923 3x19x11 1/2" 36.50
LG-1927 7x19x11 1/2" 50.50

LG- Black anodized rack cabinet

Modular Desktop Consoles



L x W x H
LE-453 4x4 3/4 x3" \$ 7.50
LE-653 6x4 3/4 x3" 9.75
LE-853 8x4 3/4 x3" 11.75
LE- Black finished aluminum panel 1mm thick.

Alarm Box with Lock



Mejor Compra!
LB-1085 8 1/2 x10 1/4 x5" \$18.75
LB-1395 9 1/4 x13 1/4 x5" 25.50
LB-1525 12 1/4 x15 1/4 x5" 35.25
*LB-1494 9 1/4 x14 1/4 x4 1/4" 21.50
LB-1383A 8 1/2 x13 1/4 x4" 23.25
*No lock & LB- Sheet Metal 0.8mm

New LL-1923B 2 1/4 x19x12" 69.50 LL-1925A 5x19x12" 79.50

*LL- High quality full Aluminum Cabinet
*LL- Front panel .157" & other panels .078"
*LL- Gold plated cap screw for front panel

- Dimensions in inches ± .05
- Custom-made for other dimensions if over 100 pcs for single model!

Camera Housing



*LD-1244 2 3/4 x10 3/4 x4" \$55.00
*LD-1516 3 3/4 x13 3/4 x4" 29.50
*LD-1565 4x13 3/4 x5 1/4" 31.75
*LD- Stainless Steel 0.7mm
*LD- Sheet Metal 1mm

Power Transformers & Toroidal Transformer

001 28/30V x 2 6A \$ 30.00
002 36V x 2 3A 25.00
003 40V x 2 6A 32.00
**008 28/30V x 2 6A 40.00
**009 48/53V x 2 8A 66.00
**012 33/40/42Vx2 6A 48.00

TA-800MK2 ▲▲ 120+120W Pre & Main Stereo Amp. (4 lbs.)



Kit: \$ 67.92
Asmb. \$ 86.95

Power Output: 120W into 4 ohms RMS. 72W into 8 ohms RMS. Frequency Response: 10-20KHZ. THD: <0.01%. Tone Control: Bass ±12dB, Mid & Treble ±8dB. Sensitivity: Phono Input, 3mV into 47K. Line, 0.3V into 47K. Signal to Noise Ratio: 86dB. Power Requirement: 40VDC @ 6A. Suggested Mark V model 001 or 008 transformer. Recommended Metal Cabinet LG-1924.

AF-3 ▲▲▲ 300W MOSFET High Power Mono Amp. (7 lbs.)

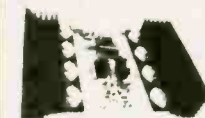

Kit: \$ 165.00 Asmb. \$ 195.00

Power Output: 300W into 4 ohms RMS. 200W into 8 ohms RMS. Frequency Response: 10HZ-20KHZ. THD: <0.03%. Signal to noise ratio: 91dB. Input Sensitivity & Impedance at 1KHZ, 1V 47K. Load Impedance 4-16 ohms. Power Requirement: ±55 to ±65VDC 8A. Suggested Mark V model 009 Transformer. Capacitor 8,200uf 100V model 020. Recommended Cabinet LG-1925 for each channel.

TA-388 ▲▲ Class A FET Dynamic Buffer Stereo Pre-Amp (1 lb.)

Best Pre-Amp



Kit: \$64.00 Asmb. \$ 80.00

Frequency Response (at rated output): Overall 10HZ-100KHZ +0.5dB-1dB. THD: Overall <0.007% at or below rated output level. Channel Separation (at rated output 1KHZ): Overall better than 70dB. Hum & Noise: Overall better than 90dB. Input Sensitivity (1KHZ for rated output): 300-600mV. Maximum Output Level: Pre-Amp output 1.8V (0.1% THD). Power Requirement: 30V X 2 AC 500mA. Suggested Mark V model 010 transformer.

SM-100 ▲▲ 150 MHZ 8 Digit Frequency Counter (2 lbs.)

Best Buy



Kit: \$ 79.00
Asmb. \$ 99.00

Frequency Range: 10HZ-150MHZ. Gate Time: 0.01s, 0.1s, 1s, 10s. Input Sensitivity: KHZ range 10HZ-10MHZ 20mV(min.). MHZ range 1MHZ-120MHZ 20mV(min.), 120MHZ-150MHZ 35mV (min.), 150MHZ-200MHZ 40mV(typical). Time Base: 10MHZ crystal, ±10 ppm. Input Impedance: 1M ohm. Response Time: 0.2s. Resolution: 0.1 HZ: 10s gate time, 1HZ: 1s gate time, 10HZ: 0.1s gate time, 100 HZ: 0.01s gate time. Hold the last input signal. Reset counter to 0. DC 9V power adapter not included.

School Educational Kits Source ...

KA-901 30-In-one electronic lab kit \$ 15.99

No soldering is required! Build a radio, alarm, timer... Earphone for private listening. Uses safe battery power. Requires 4 "AA" batteries*.

KA-902 130-In-one electronic lab kit \$ 29.99

Build 130 funny circuits. AM broadcast station, sonic fish caller, timer... No special tools or soldering required due to premounted parts, pre-cut wires and simple coil-spring connectors. Requires 6 "AA" batteries*.

KA-904 500-In-one electronic lab kit \$ 98.99

Contains its own computer with a simple explanation of the basic(Assembler) language required for operation. Compile programs to discover how computers operate while gaining an understanding of hardware & software. With easy-to-follow manual which explains by comprehensive diagrams. Requires 6 "AA" batteries.

KA-905 75-In-one electronic lab kit \$ 24.99

Build strobe light, touch switch, digital circuits, electronic organ... No special tools or soldering required. Requires 4 "AA" batteries*.

KA-906 300-In-one electronic lab kit \$ 59.99

Learn about power amplifier, operation amplifier, digital, test instrument & fun games... It even includes a breadboard for adding your own components. Complete with easy-to-follow manual. Requires 6 "AA" batteries*.

*Batteries are not included!



KA-906



KA-904

See our catalog for more kits!

Minimum order \$ 20. We accept Visa, MasterCard & Money Orders. Checks allow 2 weeks for clearance. We ship by UPS ground inside US (2 lbs min \$ 6.00) and ship by US mail outside US. Please call for orders shipping & handling or fax (foreign) orders. PO Orders are welcome from schools. We are not responsible for typographical errors.

"7-WAY COPY CAT \$1295.00*"

NEW!
7-Way
StarTac
\$1995.*

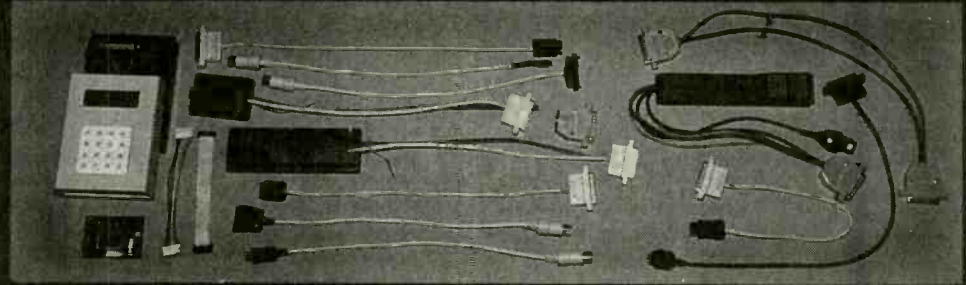

- Does.. 1. MOTOROLA (includes elite and EE3)! 2. NEC (includes P100-200-300-400-600-700)! 3. AUDIOVOX (does new 800 & 850)! 4. PANASONIC! 5. SONY (H333)! 6. MITSUBISHI-DIAMONDTE.L! 7. GE-ERICSSON (includes new version)!

We offer complete upgrade options on older units as well as new and replacement cables. We also offer used and refurbished units. For a complete catalog, visit us on the web at www.celltec.com

Upgrade
 Your Old Copy
 Cat **NOW**
 to a **7-Way**
 with **EE3**
 & **StarTac**
 *cables optional

All units are sold for **EXPERIMENTAL AND EDUCATIONAL PURPOSES ONLY!**

CALL US TODAY AT 770.973.8474

CIRCLE 328 ON FREE INFORMATION CARD

Radiotelephone - Radiotelegraph

FCC Commercial License

Why Take Chances?

Discover how easy it is to pass the exams. Study with the most current materials available. Our Homestudy Guides, Audio, Video or PC "Q&A" disks make it so fast, easy and inexpensive. No college or experience needed. The new commercial FCC exams have been revised, covering updated Aviation, Marine, Radar, Microwave, New Rules & Regs, Digital Circuitry & more. We feature the Popular "Complete Electronic Career Guide". 1000's of satisfied customers **Guarantee** to pass or money back. Newest Q&A pools.

Send for **FREE DETAILS** or call
1-800-800-7588

WPT Publications
 4701 N.E. 47th St.
 Vancouver, WA 98661

Name _____

Address _____

City _____ St. _____ Zip _____

1-800-800-7588

NOW
YOU CAN "SEE"
INVISIBLE FIELDS
AND AVOID THEM



Most homes and offices have hot spots with strong artificial electro-magnetic fields, where chronic exposure may cause mental or physical problems. Even the EPA names these fields as suspected carcinogens. You can reduce your risk by avoiding these high-field areas.

The **TriField**™ meter detects *far more* of these fields than any other electromagnetic pollution meter. It's the only one that independently reads AC electric fields, AC magnetic fields, and radio/microwaves. It also reads field strengths in *all directions simultaneously*. Every other meter that sells for under \$500 reads only magnetic and only in one direction — they can entirely miss a magnetic field unless pointed correctly and are blind to radio/microwaves and electric fields, both of which cause biological effects.

The **TriField**™ meter reads all three types of fields numerically and with a **SAFE/BOFCERLINE/HIGH SCALE**, weighted proportional to effect on the body. Thresholds are based on epidemiological and laboratory studies. (While no *absolute* hazard thresholds have been established, reduction of *relative* exposure is prudent.)

The **TriField**™ meter comes ready-to-use with battery, instructions, and one-year limited warranty. The cost is \$144.50 postpaid.

AlphaLab, Inc. / 1280 South Third West / Salt Lake City, UT 84101-3049
 For literature and information, call (808) 874-9126

Roger's Systems Specialist

800-366-0579

"We Have Great Connections"

Internet Catalog Online! <http://www.rogerssystems.com>
Cables ★ Connectors ★ Accessories

Computer • Telecommunications • Network • Audio • Video

PC Compatible Joysticks

- Ergonomic design
- 3 positive fire buttons & trigger
- 6ft cable
- High quality 15 pin connector

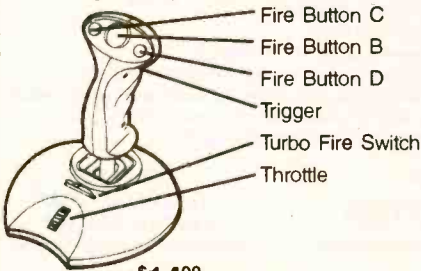

\$14⁰⁰ each

Also Available

19 Button Digital Programmable Model
 \$28⁰⁰ each

2 Computers to 1 Parallel Printer

Manual/Auto Switch • Easy to install and operate
 All DB25 female connections

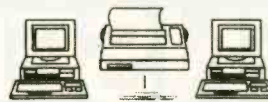

#DS-201P \$10⁰⁰ each

Magnavox Remote

Preprogrammed
 Operates all primary functions
 and some extras
 for TV, VCR, Cable Box

The perfect replacement for lost or broken remotes

TM-REM-MAG
 \$10⁰⁰ each
Blow Out!

For a limited time,
Roger's Systems will offer
 these
*Relocation
 Specials!*

CPU Fan

w/ Heat Sink
 For Pentium
 Bi-Pin Connector
 Ball Bearing

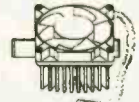

\$2⁰⁰ each

100/\$1.60 each

3.6 Volt 60 mA_H Nickel-Metal Hydride Battery

Replacement for
 Motherboards
 Solder Opt.

MFG. by Varta
#TM-3V/60H
 \$3⁵⁰ each
 20/\$3.00

10' Bi-Directional Printer cable

DB25 male to standard 36 Centronics



Cable for HP Laser
 and others meets
 1284-IEEE standards

#CC-PRI-1284 \$10⁰⁰ each

CD Jewel Case

Replacement for original case



#TM-CD-1

\$.40 each

10/\$.33 100/\$.25

SCSI Cable

IBM or MAC Controller to device
 DB25 to 50 pin Centronics male to male

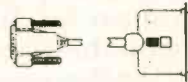

#CC-669

3 foot \$2⁰⁰ each

Close Out!

12v DC Fan

3 1/8" x 1" Ball
 Bearing type
 Standard
 replacement fan for
 PC/AT mini-full towers

#TM-FAN

\$3⁰⁰ each

20/\$2.50 each

SCSI 1 to SCSI 1 Cable

50 pin Centronics male to male

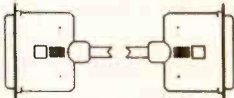

#CC-676-E

6 foot \$2⁰⁰ each

Close Out!

S-Video Cable

4ft cable
 Oxygen-Free wire
 4 pin mini
 male to male

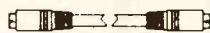

#VC-735-4

\$1⁰⁰ each

50/\$.75

I-EEE-1284 Printer Cable

10; Bi-Directional
 DB25 Male to Mini Centronic 36
 A.K.A. type "A" - "C"



#CC-PR6-BIMIN

\$1⁵⁰ each

Any Quantity

AT Modem Cable

DB25 male to DB9 Female

9 foot #CC-906

\$1⁵⁰ each

20/\$1.00 each

Close Out!

Roger's Systems has Moved to a larger facility!!

805-295-5977 Remember, We Have Great Connections...For You! FAX 805-295-8777

Some items limited to
 stock on hand.

\$10.00 minimum order required • Add \$4.50 shipping for pre-paid orders

Drawings are
 representations only.

California residents add 8.25% tax • eMail Sales@RogersSystems.com

Call for quantity discounts • No out of state checks accepted • Most orders shipped same day

24895 Avenue Rockefeller, Valencia, CA 91355

AMERICAN EXPRESS

DISCOVER

MasterCard

VISA

CIRCLE 323 ON FREE INFORMATION CARD

EARN MORE MONEY!

Be an FCC LICENSED ELECTRONIC TECHNICIAN!



No costly school. No commuting to class. The Original Home-Study course prepares you for the "FCC Commercial Radio-telephone License." This valuable license is your professional "ticket" to thousands of exciting jobs in Communications, Radio-TV, Microwave, Maritime, Radar, Avionics and more...even start your own business! You don't need a college degree to qualify, but you do need an FCC License.

No Need to Quit Your Job or Go To School
This proven course is easy, fast and low cost! **GUARANTEED PASS**—You get your FCC License or money refunded. **Send for FREE facts now. MAIL COUPON TODAY!**

Or, Call 1-800-932-4268 Ext. 210

COMMAND PRODUCTIONS

FCC LICENSE TRAINING, Dept. 210
P.O. Box 2824, San Francisco, CA 94126
Please rush **FREE** details immediately!

NAME _____
ADDRESS _____
CITY _____ STATE _____ ZIP _____

Motion Control System

\$299.95

INCLUDES NEW! (3) Slot Motherboard, Dual Stepper Controller Card, 12VCT 3 Amp Transformer, (2) Stepper Motors, Easy to use I.B.M Software!

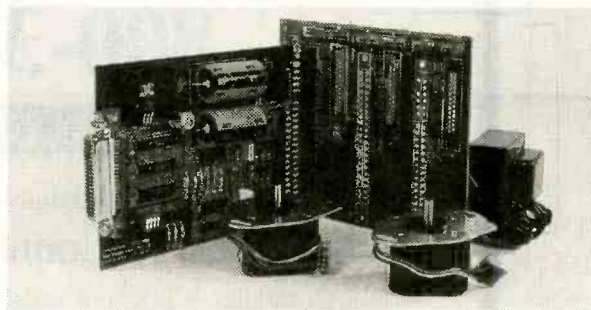

Complete System "Nothing more to Buy!"

Unit# SCK-2000

- Design Robots, Plotters, Laser Systems, CNC Machines!
- Drives (2), 100 step, 3.6 degree, 4 Phase Stepping Motors!
- Unipolar 12v motors full step control. Torque is 8oz inches!
- Bi-Directional 8 Bit Read and Write Port!
- Board Addressable, 16 Possible Choices!
- Fits in Standard 19" inch Card Rack!
- Connects to any compatible I.B.M. LPT Port (1,2,3).
- With Additional Cards Control 32 Motors on 1 LPT Printer Port!
- Features Include: Variable Speed, Step, Range, Direction, and On/Off Control!
- System is expandable, Add I/O cards, Slave cards, and Amplifier cards.
- Free QBasic & Gwbasic Source Code \$ 59.95 value! *

Send Check or M.O. to:

CYBERMATION

"Intelligent Controllers"

1943 Sunny Crest Dr., Suite 288,
Fullerton, CA 92635

Call Us Today!

Tel (714) 879-2000

Fax (714) 992-2082

Visa/Master/Amex Charge Accepted

Units are in stock and ready to be shipped!
* Add \$12.00 S&H. CA residents please add sales tax *

EASY TO USE CAD

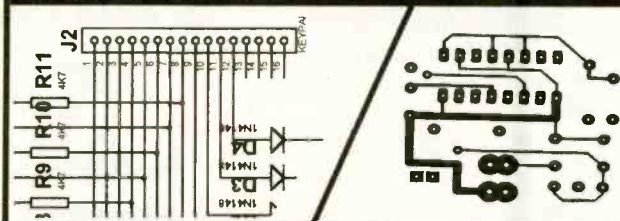

Now in
Both DOS and Windows

CADPAK DOS - \$159, **WINDOWS** - \$199

Ideal for New Users, Hobbyists, & Small Businesses! Provides everything for PCB Layout & Schematic Drawing.

PROTEUS Starts at \$425

Most Powerful on the market

- * Schematic Capture
- * Circuit Simulation
- * PCB Layout with Rip-Up & Retry Routing

R4 SYSTEMS INC.

1100 GORHAM ST. Suite 11B-332
Newmarket Ontario, Canada L3Y 7V1

905 898-0665 FAX 905 898-0683

FREE DEMO
WRITE OR CALL
TODAY

Download Demo - <http://www.r4systems.on.ca>
Internet email info@r4systems.on.ca

NOW MAKE AN EXTRA \$600 PART TIME WEEKENDS -- UP TO \$2,000 A WEEK FULL TIME IN *Explosive* SATELLITE DISH TV/ELECTRONICS FIELD!

Hottest Career Opportunity Since Invention of the VCR!

See How Fast The Money Rolls In!

Part time: *Here's what you can earn
over a typical weekend:*

Install 2 Satellite dish systems at \$200 = \$400
Repair 4 TV's at \$50 each = \$200

Total Weekend Income = \$600

Full time: *Working just five days a week
you could easily earn:*

Install 5 Satellite dish systems at \$200 = \$1,000
Repair 10 TV's, average \$50 each = \$500
Clean and adjust 10 CD players, average \$35 each = \$350
Service 2 Home entertainment centers at \$75 = \$150

Total Weekly Income = \$2,000

**In addition you can make big extra profits
on other supplies you furnish!**

Get in *THE FAST LANE* on the NEW "INFORMATION SUPERHIGHWAY" Everyone's Talking About!

It's exciting! It's gigantic! The technology of tomorrow is here today! You've been reading and hearing about the amazing Information Superhighway. It's so new that few technicians are equipped to service

this fast emerging field! Foley-Belsaw gives you Satellite dish technology (including new mini-dish) along with the electronic expertise you need to make big money servicing TVs and other electronic equipment.

Be your own boss! It's quick and easy to become an expert at home in your spare time. Earn really BIG money adjusting, installing and repairing • *Satellite dish systems* • *TV's* • *Amplifiers* • *CD players* • *AM/FM tuners* • *Home entertainment centers*. Every home, every business, every office in your area desperately needs your expertise!

Your timing just couldn't be better! Never before and probably never again will you have a ground-floor opportunity like this to get into a booming business of your own, make really big money starting right away, be your own boss and enjoy financial freedom and security. The fact you're reading this message shows you're smart enough to realize this!

Satellite dish/TV/Electronics is easy

to learn in your spare time at home. This modern, practical hands-on course combines simple step-by-step lessons with easy-to-follow video cassette guidance. No special experience or electronics background is necessary. Just average mechanical aptitude and the ability to follow simple A-B-C repair procedures that are clearly outlined for you.

And when you complete the course you will receive Foley-Belsaw's official diploma attesting to your expertise.

**30-DAY
NO RISK TRIAL**
Send for details



Send coupon today for FREE Fact Kit. No obligation.

Don't miss out on this once-in-a-lifetime opportunity. Send in the coupon NOW. Get all the facts and study them in the privacy of your own home. There's absolutely no obligation and no salesman will call on you. So don't delay. Mail the coupon today!

MAIL TODAY FOR FREE INFORMATION PACKAGE

Foley-Belsaw Institute
6301 Equitable Road
Kansas City, MO 64120-1395



- YES!** Without obligation send free information kit so I can learn how to become a professional Satellite Dish/TV/Electronics Specialist, in order to earn high extra income. Dept. 31426
- VCR Repair**—Unlimited profits in this growing field. Dept. 62654
- Interested in an exciting, money making career in Computer Repair, Maintenance and Upgrade?** Dept. 64552
- Personal Computer Programming**—Learn fast at low cost for big earnings. Dept. 35372

Name _____

Address _____

City _____ State _____ Zip _____

Call toll-free 1-800-487-2100

CIRCLE 321 ON FREE INFORMATION CARD

Fix It Yourself!

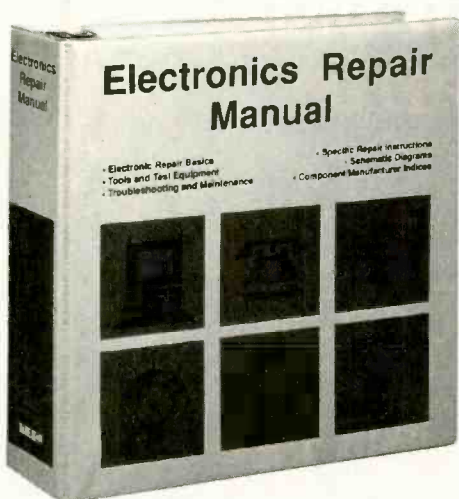

- Hands-on, detailed, troubleshooting instructions
- "How to" primer for test equipment: oscilloscopes, frequency counters, video analyzers, etc.
- Schematic diagrams
- Trouble analysis flowcharts
- Preventive maintenance techniques
- Safety precaution checklists
- Comprehensive replacement parts list
- Directory of manufacturers

It's easy, fast, and rewarding to repair it yourself with the Electronics Repair Manual!

Leading Manufacturers Represented...

- Emerson • Nintendo • RCA • Technics
- Hitachi • Panasonic • Sanyo • Toshiba
- IBM • Pioneer • Sharp • Zenith
- NEC • Quasar • Sony and others!

✓ Dozens of Fix-It-Yourself Projects for...

- | | |
|---|--|
| <input type="checkbox"/> CD Players | <input type="checkbox"/> Amplifiers |
| <input type="checkbox"/> VCRs | <input type="checkbox"/> Car Radios |
| <input type="checkbox"/> Televisions | <input type="checkbox"/> Home Appliances |
| <input type="checkbox"/> Camcorders | <input type="checkbox"/> AM/FM Tuners |
| <input type="checkbox"/> Computer Equipment | <input type="checkbox"/> Thermostats |
| <input type="checkbox"/> Fax Machines | ...and more! |
| <input type="checkbox"/> Telephones | |

30-Day Free Trial!



Keep Your Skills Up-to-Date!

The Electronics Repair Manual and the Modern Manual Electronics Manual will be a valuable reference for years to come. Supplements, each containing over 125 pages, add new repair projects, valuable insights into new technologies, diagnostic and repair techniques, electronics projects, and more schematic diagrams into your manual. Just \$35 each for Electronics Repair and \$49.50 each for Modern Electronics plus shipping and handling. Supplements are sent 4-5 times a year and are fully guaranteed. Return any supplements you don't want within 30-days and owe nothing. Cancel anytime.

CIRCLE 319 ON FREE INFORMATION CARD

Digital Oscilloscopes

New From Fluke!

- Model 123 Scopemeter
- 20 MHz, dual channel
- Connect-and-View
- "Paperless" recording
- True RMS, 5000 count
- NiCd battery



123 Scopemeter, 2x20 MHz	\$945
123S Scopemeter with RS232, software, hard case	\$1225
92B Scopemeter, 2x60 MHz	\$1440
96B Scopemeter, 2x60 MHz	\$1695
98 Automotive Scopemeter	\$2495
99B Scopemeter, 2x100MHz	\$2085

HAMEG

- Model HM1507 Analog/Digital Oscilloscope
- 150 MHz, 2 chan.
- Dual time base
- 200 MS/s sampling
- Autoset, CRT R/O
- RS232 included



HM1507 Analog/Digital, 2x150 MHz	\$1880
HM305 Analog/Digital, 2x30 MHz	\$1135

TEKTRONIX

- THS720A TekScope, 2x100MHz, DMM, 5mV/div, NiCd, RS232
- \$2195
- TDS220 2x100MHz, 1GS/s, cursors, LCD, Opt'l, RS232, 3.25 lbs!
- \$1645
- TDS210 Like TDS220 except 60 MHz
- \$945

Analog Oscilloscopes

HAMEG

- HM1505 2x150 MHz, 1 mV/div, Auto-Set, CRT R/O cursors, 2 T.B., RS232
- \$1395
- HM1004 2x100 MHz, 1 mV/div, Auto-Set, CRT R/O cursors, 2 T.B., RS232
- \$1295
- HM304 2x35 MHz, 1 mV/div, Auto-Set
- \$835

GOLDSTAR

- OS9100P 2x100MHz, 2mV, delay swp
- \$899
- OS9060D 2x60MHz, 1mV, delay swp
- \$783
- OS9020A 2x20MHz, 1mV/div
- \$349
- OS9020G 2x20MHz, w/1MHz func gen
- \$487

Digital Graph Meters

New, improved, lower cost Fluke 867B Graphical Multimeter

- 0.025% DCV Accuracy
- 300 kHz AC Meter BW
- 1 MHz Waveform BW
- 10 MHz Freq. Counter
- Component Test
- Logic Test



FLUKE 867B Graphical Multimeter	\$860
863 Like 867 less B/L, logic, etc.	\$470

Digital Multimeters

Fluke

10 V, R, 4000 ct	\$59
11 V, R, uF, 4000 ct	\$68
12 V, R, uF, Min/Max, 4000ct	\$81
21 Like 75; yellow case	\$134
23 Like 77; yellow case	\$161

25 V, R, mA, MilSpec, (shock, vibration, water)	\$199
27 V, R, mA, Min/Max, MilSpec (shock, vibration, water)	\$269
29 II Like 79; yellow case	\$179

70 II V, R, 3200 ct	\$79
73 II V, R, A, 3200 ct	\$97
75 II V, R, mA, 3200 ct	\$129
76 RMS V, mA, R, LoR, uF, Hz, 4000 ct., Hoister	\$179
77 II V, R, mA, 3200 ct, h/str	\$154
79 II V, R, mA, LoR, uF, 4000 ct., h/str	\$175

83 V(3% DC), R, uF, mA, Hz, Min/Max., rel., 4000 ct., h/str	\$235
85 V(1% DC), R, uF, mA, Hz, Min/Max., rel., 4000 ct., h/str	\$269
87 RMS V, R, uF, mA, Hz, Min/Max., rel., 4000 ct., h/str	\$287
88 Automotive Meter	\$379
8060A RMS V(0.4% DC), R, LoR, mA dB, dBm, rel., Hz, S, 19,999 ct.	\$413

Digital Multimeters

Versatile PROTEK 506

- AC/DCV, AC/DC A, Ohms
- True RMS, dBm
- 10 MHz frequency counter
- Min/Max, relative
- Capacitance, inductance
- Dual display
- RS232 interface



506 Digital Multimeter w/software	\$198
505 Like 506 but no RS232	\$148
D910F Multimeter v, mA, R, Hz, uF, h/fe	\$94

Spectrum Analyzers

B&K Model 2625

- 0.15 to 1.05 GHz
- 100kHz-100MHz/div.
- -100 to +13 dBm
- 4 digit Freq/Marker display



Model 2625 Spectrum Analyzer	\$2395
Model 2630 2625 w/tracking gen.	\$2995
Model 2615 500 mHz Analyzer	\$1595
Model 2620 2615 w/tracking gen.	\$1895

Power Supplies

B&K 1670 Triple Output

- Variable 0-30 VDC, 0-2.5A
- 12 VDC fixed, 500 mA
- 5 VDC fixed, 500 mA
- 3 digit LCD's for VDC, ADC



B&K 1670 Triple Output DC Supply	\$189
B&K 1680 13.8 VDC fixed, 6 A peak	\$48
B&K 1682 13.8 VDC fixed, 15 A peak	\$94
Protek 3033B, 2x30V, 1.5A, 5V, 5A	\$495

AMREL Programmable Power Supplies

- Standard GPIB
- Ext. DCV program Input
- 1mV, 1 mA regulator
- Three year warranty

Model PPS1302A 0-30 VDC, 0-2.5A	\$795
Model PPS1326 0-16 or 0-30 VDC	\$1195

General Test & Measurement

Audio & Function Generators

- 0.2 to 20 MHz
- AM/FM Modulation
- 5 Digit Display
- 30 MHz counter



B&K 4040 20 MHz Swp/Func Gen.	\$475
B&K 4017 10 MHz Swp/Func Gen	\$349
Protek B803 2 MHz Swp/Func Gen.	\$299
Protek B820 200 kHz Audio Gen/Cir.	\$228

Frequency Counters, Counter/Timers

Goldstar FC2015 Counter/Timer, 0.2 Hz-150 MHz, 8 digit display	\$212
Goldstar FC2130 Counter/Timer, 0.2 Hz-1.3 GHz, Hi-Z & 50Ω inputs	\$245
Optoelectronics M1, 10Hz-1.8GHz, 1/h	\$237

Capacity Meters, RLC Bridges

AMREL AR470D Wide range, high acc	\$195
B&K 878 Wide range, dual display	\$259
B&K 810B Cap. meter, 0.1 pf-20 mf.	\$95

Power/Harmonics Meters, Clamp Meters

Fluke 41B Power/Harmonics Meter	\$1530
Fluke 39 (41B, less isolated RS232)	\$895

SPECIALS CORNER

- Excess, discontinued or old stock ALL NEW!
- Fluke 40 Power/Harmonics Mtr
- \$695
- Fluke 93 Scopemeter, 2x60 MHz, NiCd
- \$695
- Fluke 51 Digital Thermometer
- \$105
- Fluke 8062A Digital Multimeter
- \$299
- Fluke 8020B Digital Multimeter
- \$179
- Fluke 8021B Digital Multimeter
- \$159
- Fluke 801010 AC/DC Clamp Probe
- \$228
- Fluke 610 LAN Cablemapper
- \$299
- Bird 4304 Wattmtr, to 500W/1000MHz
- \$299

800-554-8305

We accept VISA/Mastercard.
Shipping charges 4%; \$5 min., \$20 max.
US sales only on Fluke.
pantech@bellsouth.net, Fax 770-772-9780

All models, accessories available. Call, fax, e-mail for prices on items not listed here. Technmart, Inc., 4900 Gaidrew, Alpharetta, GA 30202

Prototype it FAST!
with Protoboard 8851 or D3
Fully assembled 8851 or D3 PCB
All 8 1/2 inch boards w/ large price area
Supports up to 32K EPROM - 32K RAM
Chips in sockets - 8 ball operation
Drays in EPROM w/ source and 1-amp
Full docs w/ schematic - no royalties
Ready to run... \$99.00 ea.
Software Science 3780 Roundabout Rd. Cincinnati, Ohio 45244
Call for the best price! 1888 561-2060

Quality Microwave TV Systems
WIRELESS CABLE - ITFS - MMDS
ATV - INTERNATIONAL - S-BAND
Amplifiers • Antennas • Books • Components
Filters • Systems • Video Products
• RF Frequency 1990 - 2700 MHz
• Cable Ready - VHF - UHF Outputs
• SASE For "FREE" Catalog or Send \$1
PHILLIPS-TECH ELECTRONICS
PO Box 8533 • Scottsdale, AZ 85252
ORDER LINE 800-880-MMDS
CATALOG/INFO 602-947-7700
FAX LINE 602-947-7799
Visa • MC • Amx • Disc • COD's • Qty Pricing
CHALLENGER SYSTEM 33-Channel 52dB+ Gain Complete Grid \$265 Five Year Warranty FREE SHIPPING
CIRCUIT 330 ON FREE INFORMATION CARD

The Ultimate WWW Service Site
www.electronix.com
The One-Stop Service Site for Electronic Technicians
Electronix Corp 313 W Main St Fairborn, OH 45324

CABLE TV CONVERTERS AND DESCRAMBLERS

WE CARRY A FULL LINE OF CONVERTERS AND DESCRAMBLERS COMPATIBLE WITH MOST MAJOR BRANDS INCLUDING:

- Scientific Atlanta™
- Jerrold™
- Tocom™
- Zenith™
- Pioneer™

30 DAY MONEY BACK GUARANTEE
BEST PRICES FREE CATALOG

ALLSTAR ELECTRONICS

800-782-7214

HOURS: 9-6 M-F 10-3 Sat EST

It is not the intent of Allstar Electronics to defraud any pay TV operator. Anyone implying theft of service will be denied assistance. All brand names are registered trademarks of their respective owners & are used for reference only. 110-64 Queens Blvd., #465, Forest Hills, NY 11375. NO NYS SALES.

TRANSFER PAPER FOR PRINTED CIRCUITS

USE WITH REGULAR HOUSEHOLD IRON

Will not shrink

- 30 sheets for \$24.00
- 8 1/2 X 11 sheets

S&H INCLUDED

Send check or money order to

STARLET SYSTEMS

1348 Washington av. Suite # 189, Miami Beach Florida, FL 33139

MAKE CIRCUITS EASY FROM YOUR LASER OR PHOTOCOPY MACHINE

SURVEILLANCE

The Latest High Tech Professional Electronic Devices

Our latest catalog offers a HUGE selection of surveillance, counter-surveillance/privacy devices: hidden video equipment, pinhole camera w/audio \$159⁰⁰, electronic kits, telephone recording systems: 7-Hour \$125⁰⁰-16-Hour \$199⁰⁰ touch tone decoders, scanners, bug/phone tap detectors, voice disguisers, telephone scramblers, locksmithing tools, and more.

Catalog \$5.00

SPY OUTLET

P.O. Box 337, Buffalo, NY 14226
(716) 691-3476/(716) 695-8660

BEST DEALER PRICING!

CABLE DIRECT

**CONVERTERS • FILTERS
DESCRAMBLERS**

**IMPROVE YOUR IMAGE WITH
VIDEO STABILIZERS**



**100%
MONEY BACK
GUARANTEE!**

**30 DAY
FREE
TRIAL!**

FREE Cable TV Catalog.



Now you can tune-in your favorite
cable TV programming and
SAVE \$100'S - EVEN \$1000'S
on premium **CABLE TV EQUIPMENT.**

MODERN ELECTRONICS

1-800-906-6664

2125 S. 156TH CIRCLE • OMAHA, NE 68130

ELECTRONIC COMPONENTS

MOUSER ELECTRONICS



Call for your **FREE** 340
page catalog **TODAY!**

- 68,138 Products
- 128 Manufacturers
- All Orders Ship Same Day
- No Minimum Order

800-992-9943

817-483-6828 FAX: 817-483-0931
<http://www.mouser.com> catalog@mouser.com

958 North Main St., Mansfield, TX 76063

CIRCLE 285 ON FREE INFORMATION CARD

PC-Based Dual 100MHz Universal Counter \$399

- 2 internally synchronized, full-featured counters
- Built-in math functions
- 100 MHz frequency range
- 5 ppm accuracy
- Easy-to-read auto-adjustable display
- Designed and made in USA

Turn your PC into a test station with :

6 MHz Sweep/Function Generator	\$549
60 MHz Digital Storage Scope	\$749
100 MHz Digital Storage Scope	\$999

TC INSTRUMENTS INC.®

Tel: (909) 622-2006
Fax: (909) 622-7778
<http://www.tcinst.com>

We
do OEM
Distributors wanted

JAMES ELECTRONICS 1-800-676-7966



**BEST PRICE!
BEST SERVICE!**

**ALL MAJOR SYSTEMS
FOR ANY U.S. LOCALE.**

- JERROLD • ZENITH • REGAL
- PANASONIC • SCIENTIFIC ATLANTA
- MAESTRO • BOSS • TOCOM • PIONEER

**1 YEAR WARRANTY ON ALL PRODUCTS!
CALL TOLL-FREE NOW FOR PRICE QUOTE.**

1-800-676-7966

June 1997, Electronics Now

ELECTRONIX EXPRESS

For MORE Low-Priced Items Send For FREE 168-Page Catalog

WELLER SOLDERING STATION - MODEL WLC 100

- Variable power control (5 to 40 watts)
- Replaceable heating element
- Quality light-weight pencil iron

\$37⁹⁵



Part No. E0603WLC100

DUAL-TRACE OSCILLOSCOPE

Goldstar 9020

20 MHz \$339⁰⁰



SCOPE PROBE - 60 MHz

SWITCHABLE X1, X10

Part No. E05SPAK220 \$12⁹⁵

SWITCHES

8 POS DIP 60¢ ea.

Toggle Mini SPDT 50¢ ea.



COMPONENTS

LM555 10 Min. 22¢ ea.

LM741 10 Min. 27¢ ea.

74LS00 10 Min. 18¢ ea.

7805 Regulator 10 Min. 30¢ ea.

2N3904 10 Min. 6¢ ea.

PN2222 10 Min. 6¢ ea.

Red LED T 1 3/4 10 Min. 6¢ ea.

Green LED T 1 3/4 10 Min. 7¢ ea.

TERMS: Min. \$20 + shipping. School Purchase Orders, VISA/MC, Money Order, Prepaid. NO PERSONAL CHECKS, NO COD. NJ Residents: Add 6% Sales Tax.

365 Blair Road • Avenel, NJ 07001-2293
http://www.elexp.com (Email: electron@elexp.com)

800-972-2225

In NJ: 908-381-8020

Fax: 908-381-1572

CIRCLE 320 ON FREE INFORMATION CARD

AT LAST! DC-20 MHz SYNTHESIZED PERFORMANCE FOR ONLY \$795!

- DC-20 MHz, 1 Hz resolution, DC offset
- Linear/Log Sweep
- Internal/External AM
- Internal/External FM
- Internal/External PM
- Internal/External SSB
- Internal/External BPSK
- Dualtone Generation
- Internal/External FSK
- Burst
- DTMF Generation
- DTMF Detection
- Power Level Measmt

\$795

Arbitrary Waveform Generation Now Available!



The SG-100 gives you clean, 1 Hz synthesized precision and a wide diversity of modulation functions all of which can be performed using an internally generated or externally applied signal. You also get signal analysis functions that are just not offered on any other signal source such as DTMF Detection and Power Level Measurement. And because you can download new instrument functions to Flash memory, you can ensure that your SG-100 will never become obsolete.

Call, email, or fax us for your free information kit. Visit us on the web for specs and applications.



C.O.D.

P.O.

(415) 938-0240

Telnet Inc.
2455 Middlefield Way S, Mountain View, Ca. 94043
Fax: (415) 938-0241 http://www.telnet.com. email:sales@telnet.com

CIRCLE 331 ON FREE INFORMATION CARD

New and Pre-Owned Test Equipment

Goldstar



Model OS-9100P → \$899.00

Full 100 MHz Bandwidth!

- Dual-Channel, High Sensitivity
- TV Synchronization Trigger
- Calibrated Delayed Sweep
- Includes Two Probes, 2 Year Warranty

FREE SHIPPING!

ON GOLDSTAR EQUIPMENT ANYWHERE IN THE U.S. Excluding AK & HI

BK PRECISION MAXTEC INTERNATIONAL CORP. Model 4040 \$499.00

20 MHz Sweep/Function Generator

- 0.2 Hz to 20 MHz, 5 digit LED Display
- AM & FM Internal or External Modulation
- Sine, Square, Triangle, TTL, CMOS Outputs
- Burst Operation
- External 30 MHz Frequency Counter

NEW!

See us on the Web!
www.fotronic.com

1-800-996-3837

VISA MasterCard AMEX C.O.D. TOLL FREE 1-800-99-METER

CIRCLE 334 ON FREE INFORMATION CARD

Pre-Owned Oscilloscope Specials

B + K Precision 1476 10 MHz \$229.00
Great Starter Scope!

Tektronix 465	100 MHz	\$599.00
Tektronix 465B	100 MHz	\$699.00
Tektronix 475	200 MHz	\$799.00
Tektronix 475A	250 MHz	\$899.00

- The Industry Standard of Oscilloscopes
- Dual Channel, Calibrated Delayed Sweep
- Professionally Refurbished
- Aligned & Calibrated to Original Specifications
- 6 Month Warranty - The Longest Available!

LOWEST PRICES EVER!

NEW FLUKE MULTIMETERS & TEKTRONIX OSCILLOSCOPES

The Industry Standard in Multimeters

Fluke Model 87 ..\$285.00

TEKTRONIX TDS SERIES ON SALE!

Test Equipment Depot

A FOTRONIC CORPORATION COMPANY

P.O. BOX 708 Medford, MA 02155

(617) 665-1400 • FAX (617) 665-0780

email: afoti@fotronic.com

Synthesized FM Stereo Transmitter



Microprocessor controlled for easy freq programming using DIP switches, no drift, your signal is rock solid all the time - just like the commercial stations. Audio quality is excellent, connect to the line output of any CD player, tape deck or mike mixer and you're on-the-air. Foreign buyers will appreciate the high power output capability of the FM-25; many Caribbean folks use a single FM-25 to cover the whole island! New, improved, clean and hum-free runs on either 12 VDC or 120 VAC. Kit comes complete with case set, whip antenna, 120 VAC power adapter - easy one evening assembly.

FM-25, Synthesized FM Stereo Transmitter Kit \$129.95

Tunable FM Stereo Transmitter



A lower cost alternative to our high performance transmitters. Offers great value, tunable over the 88-108 MHz FM broadcast band, plenty of power and our manual goes into great detail outlining aspects of antennas, transmitting range and the FCC rules and regulations. Connects to any cassette deck, CD player or mixer and you're on-the-air, you'll be amazed at the exceptional audio quality! Runs on internal 9V battery or external power from 5 to 15 VDC, or optional 120 VAC adapter. Add our matching case and whip antenna set for a nice finished look.

FM-10A, Tunable FM Stereo Transmitter Kit \$34.95

CFM, Matching Case and Antenna Set \$14.95

RF Power Booster Amplifier



Add some serious muscle to your signal, boost power up to 1 watt over a frequency range of 100 KHz to over 1000 MHz! Use as a lab amp for signal generators, plus many foreign users employ the LPA-1 to boost the power of their FM Stereo transmitters, providing radio service through an entire town. Power required: 12 to 15 volts DC at 250mA, gain of 38dB at 10 MHz, 10 dB at 1000 MHz. For a neat, professionally finished look, add the optional matching case set.

LPA-1, Power Booster Amplifier Kit \$39.95

CLPA, Matching Case Set for LPA-1 Kit \$14.95

LPA-1WT, Fully Wired LPA-1 with Case \$99.95

Micro FM Wireless Mike



World's smallest FM transmitter. Size of a sugar cube! Uses SMT (Surface Mount Technology) devices and mini electret condenser microphone, even the battery is included. We give you two complete sets of SMT parts to allow for any errors or mishaps-build it carefully and you've got extra SMT parts to build another! Audio quality and pick-up is unbelievable, transmission range up to 300 feet, tunable to anywhere in standard FM band 88 to 108 MHz. 7/8" w x 3/8" h x 3/4" h.

FM-5 Micro FM Wireless Mike Kit \$19.95

Crystal Controlled Wireless Mike



Super stable, drift free, not affected by temperature, metal or your body! Frequency is set by a crystal in the 2 meter Ham band of 146.535 MHz, easily picked up on any scanner radio or 2 meter rig. Changing the crystal to put frequency anywhere in the 140 to 160 MHz range-crystals cost only five or six dollars. Sensitive electret condenser mike picks up whispers anywhere in a room and transmit up to 1/4 mile. Powered by 3 volt Lithium or pair of watch batteries which are included. Uses the latest in SMT surface mount parts and we even include a few extras in case you sneeze and loose a part!

FM-6, Crystal Controlled FM Wireless Mike Kit \$39.95

FM-6WT Fully Wired FM-6 \$69.95

Call for our Free Catalog !

RAMSEY

Super Pro FM Stereo Radio Transmitter



A truly professional frequency synthesized FM Stereo transmitter station in one easy to use, handsome cabinet. Most radio stations require a whole equipment rack to hold all the features

we've packed into the FM-100. Set frequency easily with the Up/Down freq buttons and the big LED digital display. Plus there's input low pass filtering that gives great sound no matter what the source (no more squeals or swishing sounds from cheap CD player inputs!) Peak limiters for maximum "punch" in your audio - without over modulation, LED bargraph meters for easy setting of audio levels and a built-in mixer with mike and line level inputs. Churches, drive-ins, schools and colleges find the FM-100 to be the answer to their transmitting needs, you will too. No one offers all these features at this price! Kit includes sharp looking metal cabinet, whip antenna and 120 volt AC adapter. Also runs on 12 volts DC.

We also offer a high power export version of the FM-100 that's fully assembled with one watt of RF power, for miles of program coverage. The export version can only be shipped outside the USA, or within the US if accompanied by a signed statement that the unit will be exported.

FM-100, Professional FM Stereo Transmitter Kit \$299.95

FM-100WT, Fully Wired High Power FM-100 \$429.95

Speech Descrambler Scrambler



Decode all that gibberish! This is the popular descrambler / scrambler that you've read about in all the Scanner and Electronic magazines. The technology used is known as speech inversion which is compatible with most cordless phones and many police department systems, hook it up to scanner speaker terminals and you're in business. Easily configured for any use: mike, line level and speaker output/inputs are provided. Also communicate in total privacy over telephone or radio, full duplex operation - scramble and unscramble at the same time. Easy to build, all complex circuitry contained in new custom ASIC chip for clear, clean audio. Runs on 9 to 15VDC, RCA phono type jacks. Our matching case set adds a super nice professional look to your kit.

SS-70A, Speech Descrambler/Scrambler Kit \$39.95

CSS, Custom Matching Case and Knob Set \$14.95

SS-70AWT, Fully Wired SS-70A with Case \$79.95

AC12-5, 12 Volt DC Wall Plug Adapter \$9.95

Tone-Grabber Touch Tone Decoder / Reader



Dialled phone numbers, repeater codes, control codes, anywhere touch-

tones are used, your TG-1 will decode and store any number it hears. A simple hook-up to any radio speaker or phone line is all that is required, and since the TG-1 uses a central office quality decoder and microprocessor, it will decode digits at virtually any speed! A 256 digit non-volatile memory stores numbers for 100 years - even with the power turned off, and an 8 digit LED display allows you to scroll through anywhere in memory. To make it easy to pick out numbers and codes, a dash is inserted between any group or set of numbers that were decoded more than 2 seconds apart. The TG-1 runs from any 7 to 15 volt DC power source and is both voltage regulated and crystal controlled for the ultimate in stability. For stand-alone use add our matching case set for a clean, professionally finished project. We have a TG-1 connected up here at the Ramsey factory on the FM radio. It's fun to see the phone numbers that are dialed on the morning radio show! Although the TG-1 requires less than an evening to assemble (and is fun to build, too!), we offer the TG-1 fully wired and tested in matching case for a special price.

TG-1, Tone Grabber Kit \$99.95

CTG, Matching Case Set for TG-1 Kit \$14.95

TG-1WT, Fully Wired Tone Grabber with Case \$149.95

AC12-5, 12 Volt DC Wall Plug Adapter \$9.95



Mini-Peeper Micro Video Camera

Super small, high quality fully assembled B & W CCD TV camera the size

of an ice cube! Provides excellent pictures in low light (2 lux), or use our IR-1 Infra-Red light source to invisibly illuminate an entire room on a pitch black night! Imagine the possibilities... build it into a smoke detector, wall clock, lamp, book, radio.

Exact same camera that's in big buck detective catalogues and stores. Kit includes: fully assembled CCD camera module, connectors, interface PC board kit with proper voltage regulation and filtering, hook-up details, even a mini microphone for sensitive sound! Two models available: Wide Angle Lens 3.6mm/1/2, adjustable focus lens, 92 degree view; Pinhole Lens 5.5mm/1/4.5, 60 degree view. The Pinhole Lens is physically much flatter and provides even greater depth of focus. The camera itself is 1.2" square. The Wide Angle Lens is about 1" long, Pinhole Lens about 1/2", interface PC board is 1" x 2" and uses RCA jacks for easy hook-up to VCRs, TVs or cable runs. Power required is 9 to 14 VDC @ 150 mA. Resolution: 380 x 350 lines. Instruction manual contains ideas on mounting and disguising the Mini-Peeper along with info on adding one of our TV Transmitter kits (such as the MTV-7 unit below) for wireless transmission!

MP-1, Wide Angle Lens CCD TV Camera Outfit \$169.95

MP-1PH, Pin-Hole Lens CCD TV Camera Outfit \$189.95

MicroStation Synthesized UHF TV Transmitter



Now you can be in the same league as James Bond. This transmitter is so small that it can fit into a pack of cigarettes - even including a CCD TV camera and battery! Model airplane enthusiasts put the MTV-7A into airplanes for a dynamite view from the cockpit, and the MTV-7A is the transmitter of choice for balloon launches. Transmitter features synthesized, crystal controlled operation for drift-free transmission of both audio and video on your choice of frequencies: Standard UHF TV Channel 52 (which should only be used outside of the USA to avoid violating FCC rules), and 439.25 MHz or 911.25 MHz which are in the amateur ham bands. The 439.25 MHz unit has the nice advantage of being able to be received on a regular "cable-ready" TV set tuned to Cable channel 68, or use our ATV-74 converter and receive it on regular TV channel 3. The 911.25 MHz unit is suited for applications where reception on a regular TV is not desired, an ATV-79 must be used for operation. The MTV-7A's output power is almost 100 mW, so transmitting range is pretty much "line-of-sight" which can mean many miles! The MTV-7A accepts standard black and white or color video and has its own, on-board, sensitive electret microphone. The MTV-7A is available in kit form or fully wired and tested. Since the latest in SMT (Surface Mount Technology) is used to provide for the smallest possible size, the kit version is recommended for experienced builders only. Runs on 12 VDC @ 150 mA and includes a regulated power source for a CCD camera.

MTV-7A, UHF TV Channel 52 Transmitter Kit \$159.95

MTV-7AWT, Fully Wired Channel 52 Transmitter \$249.95

MTV-7A4, 439.25 MHz TV Transmitter Kit \$159.95

MTV-7A4WT, Fully Wired 439.25 MHz Transmitter \$249.95

MTV-7A9, 911.25 MHz TV Transmitter Kit \$179.95

MTV-7A9WT, Fully Wired 911.25 MHz Transmitter \$269.95

ATV-74, 439.25 MHz Converter Kit \$159.95

ATV-74WT, Fully Wired 439.25 MHz Converter \$249.95

ATV-79, 911.25 MHz Converter Kit \$179.95

ATV-79WT, Fully Wired 911.25 MHz Converter \$269.95

RAMSEY ELECTRONICS, INC.

793 Canning Parkway
Victor, NY 14564

Order Toll-free: 1-800-446-2295
Sorry, no tech info or order status at this number

Technical Info, Order Status
Call Factory direct: (716) 924-4560



ORDERING INFO: Satisfaction Guaranteed. Examine for 10 days, if not pleased, return in original form for refund. Add \$4.95 for shipping, handling and insurance. Orders under \$20, add \$3.00. NY residents add 7% sales tax. Sorry, no CODs. Foreign orders, add 20% for surface mail or use credit card and specify shipping method.

CIRCLE 266 ON FREE INFORMATION CARD

REMOTES Remote Control for Any Application

NEW NEW NEW NEW NEW

3.5" x 2.75"

\$69⁹⁵



- 3 Channel Receiver
- Channel 1 - 5 amp Relay, N/O, N/C
- Channel 2 and 3 Digital Outputs
- Compatible with 2 Button or 4 Button Remote
- Code Hopping Receiver at 434 Mhz
- Compatible with All Garage Doors and Some Car Alarms

2.75" x 2.75"

\$99⁹⁵



- 6 Channel Receiver with Digital Outputs
- All Channels are Programmable for Momentary, Latched, Latched with Condition 30-60-90 Sec. Timed Outputs
- Code Hopping Receiver at 434 Hhz
- Compatible with 2 Button or 4 Button Remote
- Compatible with Some Car Alarms

1.25" x 1.75"

\$29⁹⁵



- 2 Button - 3 Channel Remote
- Extra Long Range 434 Mhz with S.A.W. Resonator
- Push Both Buttons together for Channel 3

1.25" x 1.75"

\$39⁹⁵



- 4 Button - 15 Channel
- Extra Long Range 434 Mhz S.A.W. Resonator
- Push Combination of Buttons together for Channel 5 through 15. i.e.: Push Button 1 and 2 together for Channel 5

Street Smart Security ■ 800-908-4737

7147 University Avenue • La Mesa, CA 91941

Send, Fax or Call Order In - Use Credit Card or Check. Fax (619) 462-0652

WE SELL RED, BLUE-GREEN & IR

LASERS

**HUNDREDS OF UNITS TO CHOOSE FROM!
PRICES AS LOW AS \$40.00!**

- Experiments
- Laser Light Shows
- Cutting & Burning
- Communications

We also carry books and plans about LASERS.

CALL FOR FREE CATALOG!

TEL (909) 278-0563

FAX (909) 278-4887

MWK INDUSTRIES

1269 W. Pomona, Corona, California 91720

See our catalog on the internet.

HTTP://WWW.MWKINDUSTRIES.COM

EMAIL: MKENNY1989@AOL.COM



TEST EQUIPMENT SALES



TEK 2465.....\$2695

300MHz 4 channels. CRT readout, delta volts, cursors, delayed sweep, time measurement and save features.

TEK 1240.....\$ 895

Logic Analyzer. With D1 (9 channel, 100 MHz) and D2 (18 channel 50 MHz) acquisition cards. Complete with all accessories.

TEK SG503.....\$ 650

Signal Generator. Frequency range of 250 KHz to 250 MHz. 3 digit LED. Must be powered by TM-500 mainframe.

HP 436A.....\$1295

Power Meter. Frequency range 100kHz to 18GHz, 10W to 100mW. 4 digit LED. Requires power sensor.

HP 8012B.....\$ 595

Pulse Generator. 1 Hz to 50 MHz, variable transition times down to 5ns, selectable source impedance, pulse delay.

HP 6205B.....\$ 225

Dual output. 0-40 volts @ 300 mA or 0-20 volts @ 600 mA. Metered and adjustable.

MC & VISA ACCEPTED

NEW SCOPES IN STOCK

P.O. BOX 986
LONDONDERRY, NH 03053

PHONE (800) 684-4651
FAX (603) 425-2945

ASK ABOUT OUR NEW
TEKTRONIX & FLUKE
PRODUCTS

VIDEO-TRANSMITTERS

SMALLEST IN THE WORLD. Size only 1" X 0.6", X-tall controlled, UHF CABLE \$9, \$89.00, range 300 feet, uses 9V battery, 900 MHz, \$99.00, range 300 feet, high quality Check/MO. **BROADCAST EQUIPMENT**, FM Radio & TV Professional Studio transmitters & Microwave Radio Links **VOSTEK ELECTRONICS** Fax/Tel: 1-416-423-7024 P.O. Box 60043-1052 Pape Ave. TORONTO, ONT, M4K 3Z3

http://www.vostek.com

CABLE TV CONVERTERS

Equipment & Accessories
Wholesalers Welcome

Call C&D ELECTRONICS

1-888-615-5757 M-F 10a-6p

BUGGED??

SAVERDROPPING is unbelievably widespread! Electronic Devices with amazing capabilities can be monitoring your telephone and room conversations RIGHT NOW! Are you sure you're safe? **FREE CATALOG** tells you fast! Includes Free Bonus details on fantastic opportunities now open in Counter-Surveillance field. Exciting, Immensely interesting and EXTREMELY profitable (up to \$250 hr) full/part-time income. Call Now! **1-800-732-5000**

Electronic CAD for Windows

Professional Windows EDA tools at an affordable price with powerful features to make designing faster. WinBoard PCB layout delivers sophisticated interactive routing for complex designs, plus it has the tools needed for high-speed circuits, analog, RF and SMT designs.

WinDraft® Schematics

- ◆ Use True-Type fonts. Quickly copy and paste into other applications.
- ◆ Supports hierarchical designs, electrical rules checking, Annotation & Bill of Materials.
- ◆ Thousands of library parts and symbol editor included.

WinBoard™ PCB layout

- ◆ Supports 16 layers, multiple copper pours, and advanced features for RF designs.
- ◆ SMD & through hole library with on-line graphical editor.
- ◆ CAM outputs include BOM, in-circuit test, NC Drill, Gerber, Pick & Place, & Advanced Design Rule Checking (DRC).

With our unique *pin capacity* versions you only pay for what you need. You choose the base configuration to suit your needs today, and expand that configuration to handle increased pin capacity as your design requirements change.

New Versions Available Now

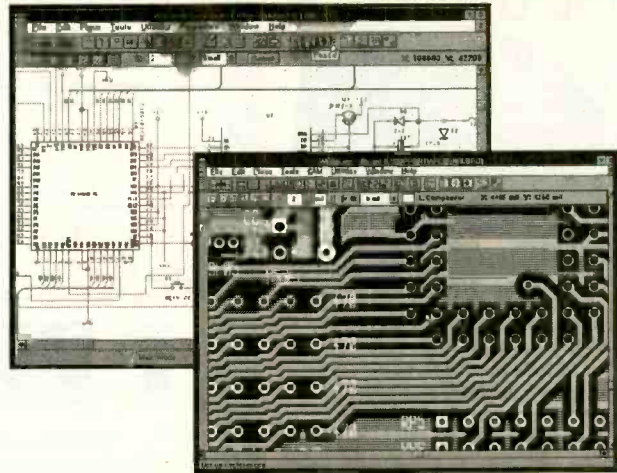

- \$ 250 WinDraft or WinBoard - P650
- \$ 495 WinDraft or WinBoard - unlimited
- \$ 895 WinBoard P650 with CCT Spectra® autorouter.

Thousands of satisfied customers are using this new generation of powerful and affordable Windows EDA tools from Ivex. Your satisfaction is guaranteed!

World Wide Web: <http://www.ivex.com>

Information and free evaluation version is available on the Ivex WW Web, FTP and BBS.

Tel: (503) 531-3555
 Fax: (503) 629-4907
 BBS: (503) 645-0576



Ivex Design International. 15232 NW Greenbrier Parkway. Beaverton, Oregon 97006. USA.

ADV2_1

CIRCLE 316 ON FREE INFORMATION CARD

PROGRAMMERS OVER 50 MODELS

ADVANTECH EETOOLS NEEDHAMS DATA I/O ICE TECHNOLOGY HILO SYSTEM GENERAL CHROMA MODULAR CIRCUIT TECHNOLOGY XELTEK



PROMAX EMP-20 MEGAMAX MEGAMAX4 SIMM/SIP TESTER EMUPA

CALL ADVANTECH LABTOOL	599 EETOOLS SIMMAX
629 ICE TECH MICROLV	795 CHROMA SIMM/SIP
650 EETOOLS ALLMAX +	359 MOD-MCT-EMUPA/R
409 EETOOLS MEGAMAX	279 MOD-MCT-EMUP/R
509 EETOOLS MEGAMAX4	49 EPROM 1G TO 512K
369 XELTEK SUPERPRO II	69 EPROM 1G TO 1MEG
409 XELTEK SUPERPRO II P	99 EPROM 4G TO 1MEG
249 XELTEK SUPERPRO L	199 EPROM 16G TO 1 MEG
165 XELTEK ROMMASTER II	89 EPROM 1G TO 8MEG
479 MOD-MCT-EMUPA	129 EPROM 4G TO 8MEG
739 STAG ORBIT-32	250 EPROM 8G TO 8MEG



LABTOOL48 MICROMASTER SUPERPRO ALLMAX PLUS ROMMASTER2

General Device Instruments

Sales 408-241-7376 Fax 241-6375 BBS 983-1234
 Web www.generaldevice.com E-Mail lcdvice@best.com

CONTROL YOUR WORLD

32K HC11
ModCon
 Low Cost Microcontroller boards & kits + Applications

ZORIN <http://zorinco.com>
 or call (206) 282-6061

To learn how to talk with your kids about tough issues, like sex, AIDS/HIV and violence, call **1-800-CHILD-44** and get your free guidebook.



Write **PIC** programs in **BASIC!**

\$99⁹⁵



PicBasic Compiler

BASIC makes it easy for you to program the fast and powerful Microchip PIC microcontrollers.

- ◆ Expanded BASIC Stamp 1 compatible instructions
- ◆ True compiler provides faster program execution and longer programs than BASIC interpreters
- ◆ In-line assembler and Call support
- ◆ **New Features!** Peek & Poke, I2Cin & I2Cout
- ◆ Supports PIC16C6x, 7x and 8x microcontrollers

PicBasic Compiler Bundle - \$179.95
 Includes: PicBasic Compiler, EPIC Programmer, AC Adapter, 25 Pin Cable, PICProto18 and PIC16F84

*BASIC Stamp is a trademark of Parallax, Inc.

microEngineering Labs, Inc.

Box 7532 Colorado Springs CO 80933

(719) 520-5323 FAX 520-1867

<http://www.melabs.com>



P
C
P
L
A
C
E

June 1997, Electronics Now

FRIENDLY LITTLE MICRO CONTROLLER

\$149
(single)

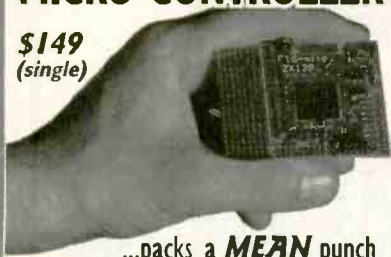

...packs a **MEAN** punch
a.k.a. "Steroid Stamp"

- 39 I/O + 8 A/D (10 bit) •
- 128K SRAM + 128K Flash •
- LCD/Keypad Interface •
- Fast 16 bit Motorola CPU •
- Affordable C Compiler •
- Comprehensive s/w Library •

* Intec Automation Inc. v: 250-721-5150
www.islandnet.com/~ili fx: 250-721-4191

ANY NEW APPLICATIONS?

COB & SMD on gold plated PCB

20-Second Voice Record & Playback Unit

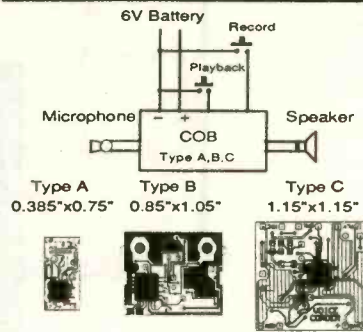

COB Design Specialist

KSL Microdevices, Inc.

(408)922-0800 FAX (408)922-0629

INSIDE CRYSTAL SETS

An easy-to-read book on crystal set theory and construction opens vistas for novices and pros alike. Build radios like Grandpa did, do it better, and know what you are doing. *The Crystal Set Handbook*, published by The Crystal Set Society, is an authentic guide on the topic.

To order *The Crystal Set Handbook*, send \$10.95 plus \$4.00 for shipping in the U.S. and Canada only to **Electronic Technology Today Inc.**, P.O. Box 240, Massapequa Park, NY 11762-0240. Payment in U.S. funds by U.S. bank check or International Money Order. Please allow 6-8 weeks for delivery.

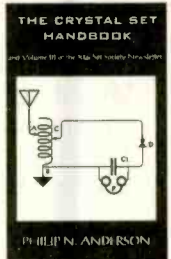

NEW! HIGH PERFORMANCE LOW COST CONTROLLER



Model: SC5-516

- Small size (4.5" x 8.6")
- 22 Mhz 80C552 MCU
- LCD & 4 x 4 keypad interface
- 8 Isolated AC/DC inputs
- 8 5A Relay outputs
- High speed input
- 128K SRAM / 128K FLASH
- Real time clock
- 256 byte serial EEPROM
- Single 12 Vdc supply
- 1 serial port (RS232/485)
- Analog & Digital expansion
- BASIC supports LCD & keypad

APPLICATION READY! ONLY \$219.95
Other Controllers & Expansion Boards Available.

SYLVA Control Systems a division of Sylva Energy Systems Inc.

519 Richard Street, Thunder Bay, Ontario, Canada P7A 1R2

Ph. 807-768-2487 Fax 807-767-0587

www.sylvacontrol.baynet.net Email: sylva@mail.baynet.net

ADAPT-11 68HC11 Module for Solderless Breadboards

- miniature 2.0" by 2.8" module
- plugs vertically into solderless breadboard for easy experimenting
- use BASIC, C, or assembler
- BOOT/RUN switch for downloading your program via serial port
- includes RS-232 interface, 5V regulator, reset chip with pushbutton, & 12V power connector
- all I/O lines on dual row connector
- programs 68HC811E2 & 711E9 chips--no programmer required



Other versions & accessories available

Starter Package comes with ADAPT-11 module, 68HC811E2 microcontroller with 2K EEPROM on-chip (reprogrammable in circuit 1000s of times; no EPROM programmer or eraser required), PC serial cable for downloading code, Motorola Programming Reference Guide, ADAPT-11 User Manual, freely distributable 68HC11 software, and demo program. #AD11-SP US\$74.95 (C\$99.95) + \$5 S&H.

Use PLCCs in your Solderless Breadboard!
• Solderless breadboard socket adapters for all popular PLCC sizes from 28 to 84
• Vertical design gives maximum access to tie-points on breadboard.
Also available:
• Solderless breadboard adapters for DB9 (\$5) & DB25 (\$7.50)
• Adapters for IDC (ribbon cable) connectors from 14-pin to 60-pin. Starting at \$7.50

Visa, MasterCard, AmEx, Discover

TECHNOLOGICAL ARTS

309 Aragona Blvd., Suite 102, Box #18, Va. Beach, VA 23462
1644 Bayview Avenue, Box 1704, Toronto, ON M4G 3C2
voice/fax:(416) 963-8996 www.interlog.com/~techart

HIGH POWER AUDIO AMPLIFIER CONSTRUCTION

High Power
Audio Amplifier
Construction

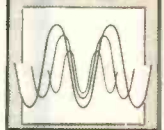

BP277—Here's background and practical design information on high power audio amplifiers capable of 300±400 watts r.m.s. You'll find MOSFET and bipolar output transistors in inverting and non-inverting circuits. To order your copy send **\$6.25 plus \$3.00** for shipping in the U.S. and Canada to **Electronic Technology Today Inc.**, P.O. Box 240, Massapequa Park, NY 11762-0240. U.S. and Canada only. Payment in U.S. funds by US bank check or International Money Order. Please allow 6-8 weeks for delivery.

MA03

ROBOTIC MACHINING

ROUTE, MILL, DRILL, CARVE, ENGRAVE, PAINT
IN WOOD, PLASTIC, VINYL, PC BOARD, & LIGHT METALS!

STARTING AT
\$695.00

- 4 & 5 MOTOR GANTRY MILL CONFIGURATIONS
- PC COMPUTER CONTROLLED CNC/DNC
- IMPORT/EXPORT FILES TO OTHER CADS
- AUTO-BACKLASH COMPENSATION
- PRE-MACHINED HEAVY CASTINGS
- SIMULTANEOUS 4 AXIS MOTION
- FREE 3D CAD/CAM SOFTWARE
- AVAILABLE IN KITS OR ASSEMBLED
- EXPEDITE SERVICE ALSO AVAILABLE
- OPTIONAL ALUMINUM WAY COVERS
- .0005" RESOLUTION / AMERICAN MADE



3 & 4 AXIS UNITS
FROM 12" X 12" TO
66" X 66" MACH. AREA

U.S. CYBERLAB, INC. 14786 SLATE GAP RD., WEST FORK, AR 72774

CALL NOW FOR INSTANT SPECS 501-839-8293 24 HR. FAX-BACK

Learn MICROCONTROLLERS EMBEDDED SYSTEMS and PROGRAMMING...

...with the AES learning system/
embedded control system.
Extensive manuals guide you
through your development
project. All programming and
hardware details explained.
Complete schematics. Learn to
program the LCD, keypad digital,
analog, and serial I/O. for your applications.



**THREE MODELS AVAILABLE. Choose from an
Intel 8051, Intel 8088, or Motorola 68HC11
based system. All models come with:**

•32K Byte ROM, 32K Byte RAM • 2 by 16 Liquid Crystal Display • 4
by 5 Keypad • Digital, Analog, and Serial I/O • Interrupts, timers, chip-
selects • 26 pin expansion connector • Built-in Logic Probe • Power
Supply (can also be battery operated) • Powerful ROM MONITOR to
help you program • Connects to your PC for programming or data
logging (cable included) • Assembly, BASIC, and C
programming (varies with model) • Program disks with Cross Assembler
and many, well documented, program examples • User's Manuals:
cover all details (over 500 pages) • Completely assembled and ready to
use • Source code for all drivers and MONITOR • Optional Text Book

Everything you need. From \$279.
Money Back Guarantee

Call for Free Info Pack, or see
WEB at <http://www.aesmicro.com>
714-550-8094, FAX 714-550-9941



Call 1-800-730-3232

AES 970 W. 17TH STREET, SANTA ANA, CA 92706, USA

HOME AUTOMATION

World's Largest Selection!

Widest Selection of X-10 Devices Available

Hundreds of hard-to-find automation, X-10 and wireless control
products. Computer interfaces, software, development tools, light-
ing control, telephone systems, security systems, surveillance
cameras, infra-red audio/video control, HVAC, pet care automa-
tion, wiring supplies, books and videos and much more!

Packed with Pictures
& Diagrams



HOME AUTOMATION SYSTEMS, INC.

Questions: 714-708-0610 Fax: 714-708-0614
e-mail: catalog@smarhome.com
<http://www.smarhome.com/smarhome>

**Lowest Prices
Guaranteed!**

24 Hours **Call 800-SMART-HOME** 800-762-7846

The Greatest Thing Since Sliced Bread

Our free Consumer Information Catalog lists more than 200 free
and low-cost government booklets that are helpful and practical.
To get your free copy, send your name and address to:

**Consumer Information Center
Department GT
Pueblo, Colorado 81009**

DATA ACQUISITION

Affordable Hardware and Software for PC's

ANA100 Analog I/O \$ 99



- 8 Channel 8-Bit
- 0 to 5 Volt Input
- 14 TTL I/O lines
- Analog Output
- 400KHz Sampling

DIG100 Digital I/O \$ 39



- 8255 PPI
- 24 or 48 TTL I/O
Lines option
- Selectable Base
Address

ANA150 Analog/Counter... \$ 89



- 8 Channel 8-Bit
- 0 to 5 Volt Input
- 3 16-Bit Counters
- 400KHz Sampling

DIG200 Counter I/O \$ 79



- 3 16-Bit Counters
- 8 TTL Input lines
- 8 TTL Output lines
- Selectable Clock
Frequency Input

ANA200 Analog I/O \$ 79



- 1 Channel 12-Bit
- 0 to 5 Volt Input
optional bi-polar
- 100KHz / 300KHz
Sampling rate
- 24 TTL I/O lines

ANA201 Analog \$ 129



- 8 Channel 12-Bit
- x1, x5, x10, x50
Programmable
Channel gain
- 100KHz/300KHz
Sampling rate

<NEW!> PC-SCOPE II - PC Oscilloscope Software
Use with our ANA100, ANA150, ANA151, ANA200, or
ANA201 boards, for 1, 2, 4, or 8 channel capture and
display of data on your PC. Oscilloscope, Storage,
and X-Y modes of data display \$49.00



MasterCard/Visa orders accepted
More hardware and software items available. Call for information or
See our catalog on the Internet: <http://www.bsosf.com>
E-mail: sales@bsosf.com

BSOFT Software, Inc.

Phone 614-491-0832 * Fax 614-497-9971
444 Colton Road * Columbus, OH * 43207

386 SBC \$83

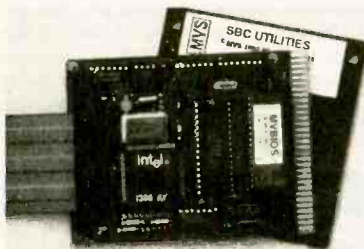

OEM (1K) PRICE
INCLUDES:
- 5 SER (8250 USART)
- 3 PAR (32 BITS MAX)
- 32K RAM, EXP 64M
- STANDARD PC BUS
- LCD, KBD PORT
- BATT. BACK. RTC
- IRQ0-15 (8259 X2)
- 8237 DMA 8253 TMR
- BUILT-IN LED DISP
- UP TO 8 MEG ROM
- CMOS NVRAM
USE TURBO C,
BASIC, MASM
RUNS DOS AND
WINDOWS
EVAL KIT \$295

\$95 SINGLE
PIECE
PRICE
**UNIVERSAL
PROGRAMMER**

- DOES 8 MEG EPROMS
- CMOS, EE, FLASH, NVRAM
- EASIER TO USE THAN MOST
- POWERFUL SCRIPT ABILITY
- MICROCONT. ADAPTERS
- PLCC, MINI-DIP ADAPTERS
- SUPER FAST ALGORITHMS



OTHER PRODUCTS:
8088 SINGLE BOARD COMPUTER OEM \$27 ... *95
PC FLASH/ROM DISKS (128K-16M) 21 75
16 BIT 16 CHAN ADC-DAC CARD 55 195
WATCHDOG (REBOOTS PC ON HANGUP) 27 95

*EVAL KITS INCLUDE MANUAL
BRACKET AND SOFTWARE.
5 YR LIMITED WARRANTY
FREE SHIPPING
HRS: MON-FRI 10AM-6PM EST



**MVS BOX 850
MERRIMACK, NH
(508) 792 9507**

Printed Circuits in Minutes Direct From LaserPrint!

8 1/2" x 11"
* Or Photocopy
**Use standard household iron or P-n-P Press.

1. LaserPrint*
2. Press On**
3. Peel Off
4. Etch



Use Standard Copper Clad Board
20 Shts \$30/ 40 Shts \$50/ 100 Shts \$100
Visa/MC/PD/CK/MO \$4 S&H

Techniks Inc.
P.O. Box 463
Ringoes NJ 08551
ph. 908.788.8249 fax 908.788.8837
<http://chelsea.ios.com/~techniks>
Retail Dealer Inquires Invited

UPGRADE YOUR COMPUTER!

Visa/MC
Webcam!

TECHNOLOGY ASSOCIATES
959 W. 5th St. • Reno, NV 89503
(702) 322-6875 • Fax (702) 324-3900

www.techass.com • sales@hoopsware.com

Memory	Hard Drives	Modems
1Mb (1x8-70 ns) \$8	WD 1.2Gb IDE \$230	33.6 Int USR Fax/Modem \$68
4Mb (4x8-70 ns) \$22	WD 1.6Gb IDE \$245	for Windows \$120
4Mb (1x32-60 ns) \$20	WD 2.1Gb IDE \$270	33.6 Int USR Fax/Modem PNP \$150
8Mb (2x32-60 ns) \$33	WD 2.5Gb IDE \$300	33.6 Ext USR Fax/Modem PNP \$175
16Mb (4x32-60 ns) \$78	WD 3.1Gb IDE \$340	33.6 Int USR Fax/Modem w/voice \$185
32Mb (8x32-60ns) \$155		
CPU's	Video Cards	Sound Cards
Cyrix 586-100 \$42	256K ISA VGA \$24	16-bit Sound Blaster Pro compatible \$27
Cyrix 586-133 \$50	Trident 8000 1mb ISA SVGA \$37	16-bit SB Pro \$75
AMD K5-PR100 \$95	Trident 9440 1mb VLB SVGA \$38	Sound Blaster 32 PnP \$115
Intel Pentium 100 \$115	Trident 9680 1mb PCI SVGA W/MPG \$38	
Cyrix 686-120 \$130		
Cyrix 686-133 \$190		
Intel Pentium 133 \$225		
Intel Pentium 150 \$550		
Intel Pentium 200 \$574		
Motherboards	Miscellaneous	Controller Cards
486soo PCI, 256K \$95	1.44Mb FDD \$28	ISA Mub I/O IDE \$13
Pentium Intel Tinton2 VX 256K pipeline \$110	1.2Mb FDD \$55	FDC, 2S/1P/1G \$13
Pentium Intel Tinton2 HX 512K pipeline \$155	8X CD-ROM IDE \$99	VLB Mub I/O, EIDE \$25
Pentium Pro \$300	HP T1000 800mb tape drive \$150	FDC, 2S/1P/1G \$16
	3-button serial mouse \$9	
	Spill-resist 101-key \$20	

Prices and availability subject to change without notice.

CALL FOR DAILY LOW PRICES!

Timid about getting on the... World Wide Web?

You've heard about the *Information Superhighway* and all the hype that goes with it! Sort of makes you feel timid about getting on the Web. Put your fears aside! A new book, *The Internet and World Wide Web Explained*, eliminates all the mystery and presents clear, concise information to build your confidence. The jargon used is explained in simple English. Once the tech-talk is understood, and with an hour or two of Web time under your belt, your friends will believe you are an Internet guru!

To order Book #403 send \$6.95 plus \$3.00 for shipping in the U.S. and Canada only to Electronics Technology Today Inc., P.O. Box 240, Massapequa Park, NY 11762-0240. Payment in U.S. funds by U.S. bank check or International Money Order. Please allow 6-8 weeks for delivery.

Zenith Test Chips

Notch Filters



www.tvfilter.com

Assembled	Kits
1 to 2 \$30 each	1 to 2 \$20 each
3 to 9 \$25 each	3 to 9 \$15 each
10 to 49 \$16 each	10 to 20 \$9 each
50 or more \$14 each	21 or more \$7 each

Video Media
P.O. Box 93/6025
Margate, Fl. 33093-6025
(954)-752-9202 Fax (954)-340-5201

TELEPHONE TEST DEVICES

- 2 Line Simulator \$185.00
 - 7 Line Simulator \$399.00
 - Caller ID Simulator \$395.00
 - 20 HZ Ringing Module \$49.95
 - 9-1-1 Training System \$370.00
- *** And Much More ***

Check out our Web Site for detailed info about our unique line of test equipment. The CID-max Caller ID Simulator is a stand alone test unit that generates 10 different Caller ID messages per the Bellcore Specs!

<http://www.infinet.com/~jectech>

1-800-631-0349

WINDOWS 95 —One Step at a Time

Don't know what to do when confronted with Microsoft's Windows 95 screen? Then you need a copy of *Windows 95—One Step at a Time*. Develop your expertise with the straight-forward presentation of the frequently-used features that make Windows 95 so valuable to the PC user.

To order Book BP399 send \$6.95 plus \$3.00 for shipping in the U.S. and Canada only to Electronics Technology Today Inc., P.O. Box 240, Massapequa Park, NY 11762-0240. Payment in U.S. funds by U.S. bank check or International Money Order. Please allow 6-8 weeks for delivery.



Medical miracles start with research

American Heart
AssociationSM
Fighting Heart Disease
and Stroke



CABLE T.V. Converters & Equipment WISE PRODUCTS

30-day money back
1-year warranty



Dealers
Welcome!

1-(800) 434-2269

Visa, MC, Amex, COD

3 Axis Motion Control System Complete, ready to run

\$ 255.50 + 12.00 S/H

Build or adapt CNC mills, CNC routers, Robots, Etc. Includes: 3 Stepping motors (70 oz/in 200 steps/rev). External board (connects to parallel port of a PC). Power supply. Cables, Manual and the MAXNC drive software, with linear, circular and helical interpolation, acceleration deceleration, full contouring, 'G' code programming, screen plot, code generation from CAD (CAM), and more.

For more information,
phone or write to:

MAXNC

6509 W. Frye Rd, Suite3
Chandler AZ 85224
Ph (602) 940-9414
Fax (602) 940-2384

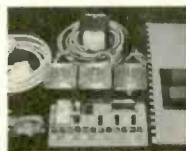

The Electronic Experimenter's Journal

It's part catalog, part magazine and part data book with kits, parts, plans, articles, and application notes.

Call for your **FREE**
copy today

Debco Electronics
4025 Edwards Rd.
Cincinnati, OH 45209

1 800 423 - 4499



New Surveillance Devices!

Smoke Alarm and Table Clock Video Cameras Ultra miniature video cameras hidden in smoke alarm or alarm clock - your choice. Wide field of view and super .1 lux low light sensitivity! Undetectable!

SC-600 High quality B/W with 420 lines of resolution for ultra sharp images. Direct output of video and audio. **\$189.95** ea.

TC-70 High quality cassette deck plugs directly into telephone jack! Records up to 12 hours of conversations on a single cassette. Recording starts and stops automatically when phone is used! **Visa/MC (800)594-1047**

Best price on surveillance cameras anywhere!

Telephone Transmitter Kit hidden in dual modular adaptor. Transmits both sides of conversation to any FM radio up to 1/4 mile. "Snap/Kit" technology. Uses phone line for power and antenna! Goes completely unnoticed. **MA-100 \$25.95**

THR-12 12 Hour Telephone Recorder High quality cassette deck plugs directly into telephone jack! Records up to 12 hours of conversations on a single cassette. Recording starts and stops automatically when phone is used! **Visa/MC (800)594-1047**

Seymour-Radix Inc. Box 166055-N Irving, TX 75016
Now you can visit us on the internet at <http://www.why.net/home/sr/>

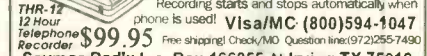
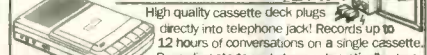

Electronic Training Videos From UCANDO

Now you can learn from the same training videos that are being used by technical schools, the Army, Navy, Air Force, Coast Guard, CET's and industries all across the United States and around the world. Advancing your troubleshooting skills has never been easier, thanks to UCANDO's extraordinary video training library. These unique training videos will teach you more in less time as you watch theory come to life. Each video is approximately one hour long and comes complete with a student workbook.



Basic Series

MODEL	DESCRIPTION	REGULAR	SALE
VT201	Direct Current: Series circuits, Parallel Circuits, Ohm's law, how to use the DMM. 55 Minutes	44.95	39.95
VT202	Alternating Current: The sine wave, coils, capacitors, transformers. 62 minutes	44.95	39.95
VT203	Semiconductors: Semiconductor theory, common diodes, transistors, switching devices. 57 Minutes	44.95	39.95
VT204	Power Supplies: Rectifier circuits, filter circuits, regular circuits, troubleshooting. 56 Minutes.	44.95	39.95
VT205	Amplifier: Amplifier basics, class A, class B, class C, operational amplifiers. 57 Minutes	44.95	39.95
VT206	Oscillators: LC and RC oscillators, crystal oscillators, crystal ovens. 56 Minutes	44.95	39.95

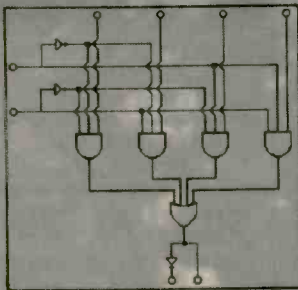
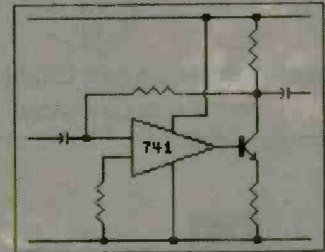

Digital Series

MODEL	DESCRIPTION	REGULAR	SALE
VT301	Digital 1: Digital basics, basic gates, binary notation, binary math, decimal notation. 54 Minutes	44.95	39.95
VT302	Digital 2: Octal notation, hexadecimal notation, flip-flops, counter circuits. 55 Minutes	44.95	39.95
VT303	Digital 3: Complement numbers, multiplexers, registers, decoder drivers, displays. 56 Minutes	44.95	39.95
VT304	Digital 4: R-2R DAC circuits, binary weighted n.o.s. slope circuits, S/A & flash circuits. 57 Minutes.	44.95	39.95
VT305	Digital 5: Memory devices, ROM, PROM, EPROM, EEPROM, SRAM, DRAM, MBM. 56 Minutes	44.95	39.95
VT306	Digital 6: The central processing unit, input devices, output devices. 56 Minutes	44.95	39.95

Other Popular Videos

MODEL	DESCRIPTION	REGULAR	SALE
VT401	AM Radio: Major stages of AM, signal conversion, signal detection, audio reproduction, AM stereo. 61 Minutes	44.95	39.95
VT402	FM Radio Part 1: Bandwidths, RF amplifier, mixer-oscillator, IF amplifier, limiter FM detector. 58 Minutes	44.95	39.95
VT403	FM Radio Part 2: Frequency doubler, stereo demultiplexer, audio amp stages, digital data encoding/decoding. 58 Minutes	44.95	39.95
VT404	TV Part 1, Intro to TV: Gain an overview of the television system and how the stages work together. 56 Minutes	44.95	39.95
VT405	TV Part 2, The Front End: UHF-VHF tuning stages, automatic fine tuning, remote control. 58 Minutes	44.95	39.95
VT406	TV Part 3, Audio: The sound strip, stereo TV, secondary audio programming, professional channels. 57 Minutes	44.95	39.95
VT501	Understanding Fiber Optics: Basic fundamentals, cable design, connectors, couplers, splicing. 58 Minutes	44.95	39.95
VT502	Laser Technology: Laser theory, types of lasers, applications, safety precautions. 57 Minutes	44.95	39.95
VT102	Intro to VCR Repair: This video is designed for the serious technician. (workbook not available). 84 Minutes	44.95	39.95
VT103	Learn How To Clean Your Own VCR: This video is not technical, but will save you money. (workbook not available). 32 Minutes	29.95	25.95

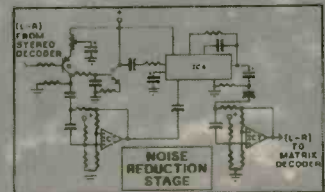

SAVE EVEN MORE!

Buy any six videos for only \$216.00. Order your UCANDO videos today!



Call for your free 84 page test instrument catalog today!!!
8931 Brookville Road * Silver Spring, Maryland * 20910

* Phone 800-638-2020 * Fax 800-545-0058 * email SMPRODINTL@AOL.com

CIRCLE 264 ON FREE INFORMATION CARD

MEREDITH INSTRUMENTS



NEW-VISIBLE
LASER DIODES
\$10

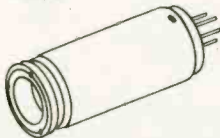

NEW-820NM LASER DIODES
WITH COLLIMATOR



GREEN OUTPUT HE-NE TUBES \$99

RUBY LASER ASSEMBLY \$295

FREE SHIPPING
ON ORDERS
OVER
\$100.00

\$20
\$35

<http://www.mi-lasers.com>

Call Or Write For A **FREE CATALOG**
On **LASERS & OPTICS**

PHONE: (602) 934-9387
FAX: (602) 934-9482

5035 N. 55TH AVE., #5, P.O. BOX 1724,
GLENDALE, AZ 85301



To learn more about life-saving techniques,
call your Red Cross.



American
Red Cross

A WHOLE NEW WORLD IN SCIENCE KITS.



TRIPLE ACTION SOLAR CAR
(No Soldering)



ROBOTIC ARM TRAINER
(No Soldering)



MOON WALKER



S-CARGO

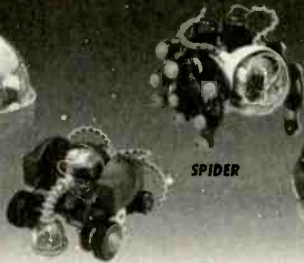

LINE TRACKER



SPIDER



HYPER PEPPY



WAO II

OWI's "Next Generation"
of affordable, rugged Robot
Kits challenge the enthusiast to
solder circuit boards and / or
mechanically assemble.

Each OWIKIT also incorporates the
basic principles of robotic experiments,
sensing and locomotion, guaranteeing
an exciting, hands-on adventure of
knowledge and fun!

*But remember! OWI is the recognized
founder and leader in Educational Robot
Kits. ACCEPT NO IMITATIONS.*

Visit our homepage
@ <http://www.owirobot.com>

ROBOTIC ARM TRAINER	OWI-007	5 Axis Control	NEW	69.95
TRIPLE ACTION SOLAR CAR	OWI-685	Solar Sensor	NEW	39.95
S-CARGO	OWI-936K	Sound Sensor	47 Pg. Book	36.95
WAO II	OWI-961K	Programmable - Graphic	59 Pg. Book	69.95
SPIDER	OWI-962K	Infrared Sensor	49 Pg. Book	49.95
LINE TRACKER	OWI-963K	Infrared Sensor	48 Pg. Book	49.95
HYPER PEPPY	OWI-969K	Sound / Touch Sensor	46 Pg. Book	24.95
MOON WALKER	OWI-989K	Solar Sensor	10 Pg. Book	34.95



EK
ELEKIT

1160 Mahalo Place, Suite B
Rancho Dominguez, CA 90220-5443
(310) 638-7970
Fax: (310) 638-8347



Order M - F: 8a.m. - 4p.m. PST

MEMBRANE SWITCH KITS!

FLAT PANEL KEYPADS
ASSEMBLE IN
MINUTES WITH YOUR
LEGEND

AVAILABLE IN 4, 12,
16, 24 & 40 KEY TYPES



DSK-4
\$9.89



DSK-12
\$14.29

INDUSTRIAL TYPES AVAILABLE

MORE THAN 30 LAYOUTS
TO FIT MOST
APPLICATIONS

CALL FOR FREE
BROCHURE

SIL-WALKER

880 CALLE PLANO,
UNIT N
CAMARILLO, CA
93012

PHONE: (805) 389-8100

FAX: (805) 484-3311

VISA / MASTERCARD

Buy recycled.



It would mean
the world to them.

Recycling keeps working to protect
their future when you buy products
made from recycled materials. For
a free brochure, write *Buy Recycled*,
Environmental Defense Fund, 257
Park Avenue South, New York, NY
10010, or call 1-800-CALL-EDE.



CIRCLE 286 ON FREE INFORMATION CARD

FM TRANSMITTER KITS! FUN PROJECTS AND MORE!

ELECTRONIC KITS!

WE ACCEPT VISA, MC, MO, COD
SHIPPING & HANDLING EXTRA
XANDI ELECTRONICS, INC.
YOUR MANUFACTURER OF HIGH QUALITY KITS
• TECH SUPPORT NUMBER (602-829-0755)



- Powerful 2 stage audio amplifier.
- Tunes 88-108 MHz.
- Up to 1 mile range.
- Requires 9V battery (Not incl.)
- Sensitive, picks up sounds at the level of a whisper.



SUPER-MINIATURE FM TRANSMITTER
Super small FM transmitter. Use with any FM broadcast receiver. Easy to assemble, all chip (SMT) parts are pre-assembled to the circuit board.

XST500 E-Z Kit \$49.95

- Sensitive audio amplifier, picks up sounds at the level of a whisper.
- Tunes 88-108 MHz.
- Up to 1/2 mile range.
- Miniature photo battery mounts right on circuit board (Included)



MICRO-MINIATURE FM TRANSMITTER
Including the battery, this is the Worlds smallest FM transmitter. Use with any FM broadcast receiver. Easy to assemble, uses pre-assembled circuit board.

XWB1000 E-Z KIT \$46.95

- Up to 1/2 mile range.
- Miniature photo battery mounts right on circuit board.
- Transmits at 143 MHz.
- Amazing audio sensitivity, picks up sounds at the level of a whisper.



CRYSTAL CONTROLLED FM TRANSMITTER

Including the battery, this is the Worlds smallest crystal controlled FM transmitter. Transmits to any scanner type receiver. Easy to assemble, uses pre-assembled circuit board.

XTL1000 E-Z KIT \$69.95

- Transmits a continuous beeping tone.
- Transmits at 143 MHz.
- Up to 1 mile range.
- Works with most any scanner type receiver.



TRACKING TRANSMITTER

Only 0.75 by 1.8 inches including the battery, the XTR300 is ideal for use in locating lost model rockets, bicycles, automobiles, games of hide and seek, and contests.

XTR300 E-Z Kit \$79.95

- Dial your phone from anywhere and listen to the sounds inside your home.
- Two digit Touch Tone code for secure operation.



TELEPHONE SNOOP

The latest in home or office security. Call home from anywhere, enter a two digit security code, and hear the sounds in your home. Automatically turns on without ringing the phone, verifies code, then activates for one and a half minutes.

XPS-CASE KIT \$14.95

XPS1000 C KIT \$55.95

- Smallest Phone transmitter anywhere!
- Tunes 88-108 MHz.
- Up to 1/4 mile range.
- Attach to phone line anywhere in house.
- No batteries required, powered by phone line.



SUPER-MINIATURE PHONE TRANSMITTER

Worlds smallest FM phone transmitter. Use with any FM broadcast receiver. Easy to assemble, all chip components are pre-assembled to the circuit board.

XSP250 E-Z Kit \$34.95

- Professional quality.
- Uses new Microwave Integrated Circuit amplifier.
- Assembly is a snap.
- Covers 1 to 2,000MHz.
- Adjustable sensitivity.
- Audio jack for privacy ear phone.



SUPER SENSITIVE BUG DETECTOR

Any intercepted signal causes an audio tone that increases from a low pitched growl to a high pitched squeal as you get closer to the source of the signal.

XBD500 E-Z Kit \$129.95

- Use with any FM broadcast receiver.
- Hear every sound in an entire house!
- Up to 1 mile range.
- Powerful 2 stage audio amplifier.



MINIATURE FM TRANSMITTER

The XFM100 has a super sensitive microphone and is capable of picking up sounds at the level of a whisper and transmitting them to any FM broadcast receiver.

XFM100 C Kit \$21.95

- Will analyze live voice best, but will work over the phone, and even from recordings
- Has built in microphone.
- Easy to use LED output display.
- Voice-stress analysis instantaneous.



VOICE-STRESS ANALYZER

SEE THROUGH LIES AND DECEIT! This is the latest breakthrough in voice-stress analysis. Know if someone is under stress such as when telling a lie

XVA250 C Kit \$49.95

- Digital voice changing: male to female, female to male, adult to child, child to adult
- Use with any modular phone.
- 16 levels of voice masking.
- Connects between handset and phone.



VOICE CHANGING ACCESSORY

STOP THOSE ANNOYING TELEPHONE CALLS! Sound older and tougher when you want to. Not a kit. Fully assembled. Use with single or multi-line phones.

TRANSITION 2001 \$69.95

- Uninterrupted coverage of 800 to 950 MHz.
- Works with any scanner that can receive 400 to 550 MHz.



800-950 MHz SCANNER CONVERTER KIT

If your scanner can receive 400-550 MHz, just add the XLC900 for uninterrupted 800-950 MHz coverage. It converts all 800-950 MHz signals down to 400-550 MHz so your scanner can receive them! Add our custom case kit for that "Professional" look.

XLC-CASE KIT \$14.95

XLC900 C KIT \$49.95

- Transmit high quality stereo to any FM stereo receiver.
- Built-in output level monitor for quick and easy tuning.
- Ideal for use with personal CD player.



FM STEREO TRANSMITTER

Transmit full-bodied Hi Fi stereo to any FM stereo receiver. Separate left and right inputs and gain controls. Includes an output booster stage for greater range.

XFS-CASE KIT \$14.95

XFS108 C KIT \$39.95

XANDI ELECTRONICS, INC.
1270 E Broadway Rd. # 113, Tempe AZ 85282

TOLL FREE ORDER LINE: 1-800-336-7389

FAX LINE: 1-602-731-4748

CALL FOR YOUR FREE CATALOG

CIRCLE 280 ON FREE INFORMATION CARD

SEND MAIL XANDI ELECTRONICS
ORDERS TO: BOX 25647
TEMPE, AZ 85285-5647

9 out of 10 mice prefer the Consumer Information Catalog online. Catch it at www.pueblo.gsa.gov.

U.S. General Services Administration



LASER

Laser Modules Laser Pointer **29 \$**

Quality that does not cost much

e-mail: ionmeter@arcos.org

Tel: (416) 204 6298

Fax: (416) 596 7619

World Star Tech. Inc.

20 Carlton Str. # 1626

Toronto, Ont. M5B 2H5 Canada

Help make your children, family, and community safer from violence! Call **1-800-WE-PREVENT** for free action ideas

TAKE A BITE OUT OF **CRIME**
U.S. Department of Justice
Crime Prevention Coalition of America



EASY PIC'n MICROCONTROLLER BOOK

How to get started using PIC16CXX microcontrollers

- Programming techniques
- Instruction set
- Addressing modes
- Bit manipulation
- Subroutines
- Sequencing
- Lookup tables
- Interrupts

- Using a text editor - source code
- Using an assembler
- Timing and counting
- Interfacing - I/O conversion
- Lots of examples

PIC is a trademark of Microchip Technology Inc. \$29.95 + \$3 mail in US VISA, MC, MO, Check CA residents please add 7.25% CA sales tax

SQUARE 1 ELECTRONICS

P.O. Box 501, Kelseyville, CA 95451
Voice (707) 279-8881 FAX (707) 279-8883
<http://www.zapcom.net/~squareone>

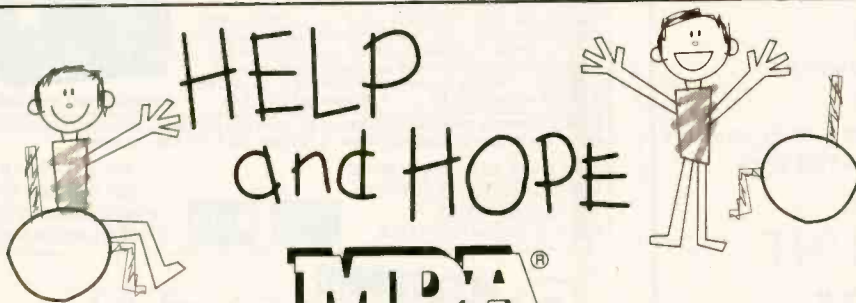

Muscular Dystrophy Association
(800) 572-1717

SPY EQUIPMENT

AI-6600 PHONE TAP DETECTOR



DETECTS:

- Radio Frequency Taps
- Series and Parallel Taps
- Line Impedance Taps
- Extension Phone Listeners

\$149⁹⁵

AI-2100 VIBRATING TRANSMITTER DETECTOR

\$189⁹⁵



DETECTS:

- Body Wires
- FM Wireless Mics
- AM Transmitters
- UHF Transmitters

AI-5500 COMPLETE SAFETY SYSTEM

DETECTS:

- All Phone Taps and Extension Phone Listeners
- All Body Wires, Wireless Mics, AM/FM and UHF Transmitters

DEFEATS:

- All Body Wires, Transmitters and Distance Microphones with its built-in white noise generator

\$379⁹⁵



TRVD-900 TRANSMITTER / TAPE RECORDER & VIDEO DETECTION SYSTEM



DETECTS:

- Body Wires • FM Wireless Mics
- AM Transmitters • UHF Transmitters
- Tape Recorders • Video Equipment

\$495⁰⁰

Alerts User By Vibrating and/or Illuminated LEDs

WSS-100 WIRELESS SURVEILLANCE SYSTEM SEES & HEARS EVERYTHING!

FEATURES:

- 2.4 GHz Video / Audio Transmitter
- 4 Channel Receiver • 300' Transmission Range
- Black & White CCD w/ Auto-Iris Lens
- 410(H) TV Line Resolution • FCC Approved Frequency



\$649⁹⁵

Items May Be Purchased by Credit Card, Certified Check, Money Order or C.O.D.

Send \$6.00
for 32-Page
Catalog
(FREE w/ Purchase)

AMERICAN INNOVATIONS, INC.

119 ROCKLAND CENTER - SUITE 315 - NANUET, NY 10954

Voice: (914) 735-6127 • Fax: (914) 735-3560

HTTP://WWW.SPYSITE.COM • E-MAIL: AMERICAN@SPYSITE.COM

Dealers &
Distributors
Welcome

Prices valid thru 9/1/97

CIRCLE 281 ON FREE INFORMATION CARD

Don't rent own!

Cable TV Descramblers

We'll beat Any Price!

- Same Day Shipping!
- 30 Day Money Back Guarantee!
- Credit Cards/C.O.D.

Have make and model number of equipment used in your area

REPLACEMENTS FOR MOST SYSTEMS

CALL TOLL FREE

CABLE DISCOUNT

1-800-684-9135

NO NEW JERSEY SALES!

Anyone implying theft of service will be denied assistance.

If he weren't constantly hungry
he might never be called
"Shrimp."

Over 12 million children in America
are suffering from hunger.
Hunger that is stunting their growth.
We can help them grow.
Simply by feeding them.
Call Second Harvest,
America's food bank network,
at 1-800-532-5200.



SECOND
HARVEST

TOGETHER WE CAN
HUNGER'S HUNGER

www.secondharvest.org

Robotic Arm Kit \$195.00



Build your own functional Robotic Arm

The kit comes complete with all hardware, base enclosure, structural components, 6 Hitec servos, MiniSSC servo controller kit, Quick Basic software and an illustrated assembly manual. This robotic arm can be controlled from any micro with a serial port! It makes an excellent addition to a small mobile robot base as well as a great foundation for artificial intelligence experiments and teaching motion control. Check out our web site for more information and other robot kits.

- Mobile version \$250.00
- Micromouse kit \$95.00
- Mobile Robots Book \$40.00

Quantity discounts available. S&H charges: \$7.50 for USA and Canada, \$25.00 for International Airmail, call for quantity shipping charges. IL residents add 6.25% sales tax to total.

Send check or money order to
Technical Service & Solutions
104 Partridge Road
Pekin, IL 61554-1403 USA



Tel: 309-382-1816
Fax: 309-382-1254
www.lynxmotion.com
jrye@lynxmotion.com

ELECTRONIC
SHOPPER

Plant Trees For America™

Trees Make a World of Difference. Thanks to trees we enjoy shadier streets, greener city parks, and friendlier neighborhoods. Trees also produce oxygen, absorb carbon dioxide, and help keep the atmosphere in balance.

This year, plant Trees for America. For your free brochure, write: Trees for America, The National Arbor Day Foundation, Nebraska City, NE 68410.



The National Arbor Day Foundation™
www.arborday.org

BEST BY MAIL

Rates: Write National, Box 5, Sarasota, FL 34230

BUSINESS OPPORTUNITIES

BUILD/REPAIR PERSONAL COMPUTERS! GUARANTEED PROFITABLE Business Opportunity. Pentium166+: \$420.00! Kit Catalog: \$1.00, Manual: \$10.00. Patrick McBrien, 109 Sagamore Trail, New Canaan, CT 06840.

\$2,000.00 WEEKLY FOR 12 Information. Stamped Envelope. Box 1061, West Babylon, NY 11704.

AWESOME INCOME Earn \$500 per sale. You do no selling! Not MLM. Residual Income! 800-877-1207 ext. 1854 (24 hrs).

COMPUTERS & SOFTWARE

IMMEDIATE INTERNET BUSINESS on two 3 1/2" diskettes \$5.00. Graphicco, Bluff City, TN 37618-0488.

EDUCATION & INSTRUCTION

HIGH SCHOOL DIPLOMA At Home, Accredited, Fast, "Failure-Proof" 1-800-470-4723. American Academy, 12651 S. Dixie Highway, Miami, FL 33156.

FINANCIAL

NEW CREDIT FILE. For FREE Information Package Call: 215-953-0222.

TOP DOLLARI FAST, courteous service buying trust deeds, mortgages, contracts. Write: White Financial, 601 South LaSalle Building - 6th Floor/Suite W511, Chicago, IL 60605.

HEALTH & FITNESS

"10 SCIENTIFIC WAYS TO LOSE FAT — (NOT MUSCLE)" send \$3: PO Box 1054-(ELE), Toledo, OH 43697.

LEADING EDGE NATURAL medicine/education — (http://www.drherbs.com) Essiac™ 501-269-4177.

PHYTO SHAPE DYNAMIC Weight Loss Product. 1-800-320-8832 Ext. 34661.

MONEYMAKING OPPORTUNITIES

FREE AMAZING VIDEO reveals Fa\$! Ca\$h secrets. Rush \$10 S&H (refundable) + telephone number: Landing Company, 400 North Madison #6, Pasadena, CA 91101. 1-888-789-3200.

DAILY LOTTERY NUMBER. Winning System Based On Mathematics. Send \$9.95 For Instructions. RMINDEES, PO Box 465-(ELE), Selingsgrove, PA 17870.

FINDER FEES ASSIGNMENTS AVAILABLE. WYATT, 2169 Oldfield-(ELE), Memphis, TN 38134.

OF INTEREST TO ALL

PREMIUM QUALITY CARNAUBA Wax Products for Auto, Home, Marine, Aircraft for Informative Brochure Write: Rayko-(ELE), 24 Iris Court, Carmel, NY 10512.

PINBALL MACHINES! BOOKS, Parts. Catalog \$2.00. 5290-(ELE) Platt Springs, Lexington, SC 29073-9252.

HOME EMPLOYMENT GUIDE! \$1.00/SASE: STEPHENSON, Box 61861, Harrisburg, PA 17106.

\$30 TO \$100 Hour. Mechanically inclined men. 1-800-785-7090 RECORDED MESSAGE.

NOW! BEAT CASINOS. Amazing Books Reveal How! Details \$1.00. Edge, Box 503-(ELE), Biloxi, MS 39533.

WIN COLORADO RECREATIONAL Ranch or Wisconsin Hunting Farm 1-800-946-7262.

VIDEOS

SPECIAL INTEREST VIDEOS & CD ROMS. Shop our 8,000 title catalog on the Internet at http://www.totalmarketing.com/91388



EZ-EP DEVICE PROGRAMMER - \$169.95

Fast - Programs 27C010 in 23 seconds.

Portable - Connects to PC Parallel Port.

Versatile - Programs 2716-080 plus EE and Flash (28F,29C) to 32 pins

Inexpensive - Best for less than \$200

- Correct implementation of manufacturer algorithms for fast, reliable programming
- Easy to use menu based software has binary editor, read, verify, copy, etc. Free updates via bbs or web page.
- Full over current detection on all device power supplies protects against bad chips and reverse insertion.
- Broad support for additional devices using adapters.

Adapters Available

EP-51 (8751,C51)	\$39.95
EP-11 (88HC11 E/A)	\$59.95
EP-PIC (16C5x,61,62x,71,84)	\$49.95
EP-PIC64 (16C62,63,64,65,73,74)	\$39.95
EP-PEEL (ICT 22V10, 20G10, 18V8)	\$59.95
EP-SEE (93x,24x,85x)	\$34.95
EP-16 (16bit 40 Pin EPROMs)	\$49.95
EP-49 (8742,48,49)	\$49.95
EP-750 (87C750,751,752)	\$59.95
EP-Z8 (Z86E03,04,05,06,07)	\$39.95
EP-55 (8755)	\$39.95
EP-51-PLCC (8751,C51)	\$59.95
EP-PIC-SOIC (16C5x,61,62x,71,84)	\$59.95
EP-PLCC (PLCC EPROMs)	\$49.95
EP-SOIC (SOIC EPROMs)	\$49.95
EP-LCC (LCC EPROMs)	\$49.95

M² Electronics

3526 Jasmine #4, Los Angeles, CA 90034
310/837-7818 Fax/BBS: 310/841-6050

http://www.ca.usa.edu/cad-grads-gs3/low/m2.html
CA orders add 8.25% sales tax. Ground shipping: \$5 3 Day - \$7, 2 Day \$10, Overnight \$17, COD \$4.75.



NEW DX SERIES DMMs

3 YEAR WARRANTY

COVERS FULL PERFORMANCE

Bel MERIT DX Series DMMs have best values for performance, features and dependability with 3 year warranty.

Each DX model has standard DMM measurements with a set of additional capabilities; diode, continuity, TRrFE, capacitance, inductance, frequency, logic and temperature.

Additional features include auto power-off, data hold, annunciator, and input warning beeper & peak hold (DX451/DX460L only)

Deluxe holster, safety test leads and thermocouple probe (DX360T) supplied as standard accessories.

MODEL	DX350	DX360T	DX400	DX405	DX451	DX460L
AC/DC Voltage (750V/1000V)	•	•	•	•	•	•
AC/DC Current (10A)	20µ •	•	•	•	•	•
Resistance (20MΩ)	200Ω •	2000M	•	•	2000M	2000M
Continuity Beeper/Diode	•	•	•	•	•	•
Temperature w/Probe, Type K	•	•	•	•	•	•
TRrFE	•	•	•	•	•	•
Capacitance (20µF)	•	•	•	•	•	2000µ
Frequency (20MHz)	•	•	•	•	•	•
Logic (TTL & CMOS)	•	•	•	•	•	•
Inductance (20H)	•	•	•	•	•	•
Auto Power-Off	•	•	•	•	•	•
Input Warning Beeper	•	•	•	•	•	•
Data Hold	•	•	•	•	•	•
Peak Hold	•	•	•	•	•	•
Protective Holster	•	•	•	•	•	•
Suggested Resale Price	49.95	64.95	64.95	69.95	89.95	109.95

• Lots more High Standard Test Instruments available

All in One Instrument, Oscilloscope, Power Supply, Function Generator, Frequency Counter, Multimeter, Capacitance, Engine Analyzer, Clamp-On, Electrical Tester and More.

• See your local distributors or Call for Catalog

Bel MERIT

1-800-532-3221
(714) 586-2310 • FAX (714) 586-3399
SOLUTIONS FOR THE TEST INSTRUMENT P.O. Box 744, Lake Forest, CA 92630

CIRCLE 325 ON FREE INFORMATION CARD

ALL PHASE VIDEO SECURITY

3-1/2 Digit Auto/Off DMM w/ Transistor Battery & Diode Test

- DC Volts to 500V
 - AC Volts 500V
 - Res. to 2 Meg Ohm
 - DC Current 200MA
- model #ST1500
17.95



Elenco Digital Capacitance Meter

- .1PF to 20,000 UF
 - Banana jack and special insertion jack included
- model #CM-1555
49.95



Pinhole Camera

- Requires 1/16" opening size
 - 1-1/4" x 1-1/4" x 5/8"
 - Power 7.5-14VDC n.a. .8 lux
 - 3.8mm lens included
 - 380 lines resolution
 - DC Power Supply 7.50
- model #CVC50PH **119.00**
w/audio & plugs

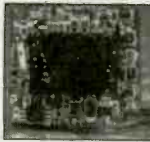

Sanyo Realtime Recorder

- 8-24-40hr • 4 head • 350 lines



model #SRT600 1 year warranty **799.95**

model #TLS972 3 day time lapse **825.00**



API Switchable Oscilloscope Probe

- 100 MHz
 - Multiple Hook-on Tips
 - XI-Ref-X10 Included
- model #510-SW-1
Special! \$24.95

Data Acquisition by... Sperry



Cutting Edge
The model DM 9100 meter has a RS 232C serial interface. Measured value pre transmitted to the computer via an interface cable and supplied software WINDOWS and MS-DOS. DCV 1000V ACV 1000V AC/DC Current 20A. Res. 40 meg. Ω freq. 10MHz temperature & more.
REG. \$209.95

model #DM9100... **169.95**

Call For FREE

Catalog & Technical Assistance

Add \$8.95 Shipping/Handling
NYS Add Tax
Visa/MC/Discover/Amex

MAIL ORDERS TO:
70 CAIN DR.
BRENTWOOD, NY 11717

ALL PHASE
VIDEO-SECURITY INC.
WHOLESALE VIDEO WAREHOUSE

1-800-945-0909

FAX: 516-435-7494

CLASSIFIED

SATELLITE EQUIPMENT

VIDEOCYpher II descrambling manual. Schematics, video and audio. Explains DES, EPROM, CloneMaster, Pay-per-view (HBO, Cinemax, Showtime, Adult, etc.) \$16.95, \$2.00 postage. Schematics for Videocypher II Plus, \$20.00. Schematics for Videocypher II 032, \$15.00. Software to copy and alter EPROM codes, \$25.00. VCII Plus EPROM, binary and source code, \$30.00. **CABLETRONICS**, Box 30502R, Bethesda, MD 20824.

DSS Bible Volume 2. All new information - No duplication from Volume 1. 200+ pages, 280+ files \$79.95 + \$5.50 P&H. **DSS Bible Volume 1** - \$49.95 PPD. **DSS Secrets** - All patents \$69.95. All - \$179.95. **VISA/MC TELECODE 1** (520) 726-2833. <http://www.hackerscatalog.com>

DSS Hacking: How to construct and program smart cards, w/plc16C84, software. Complete DSS system schematics. \$16.95. **CABLETRONICS**, Box 30502R, Bethesda, MD 20824.

OBTAINING sound for your VCII and VCII Plus is easy. No codes needed. Also **DSS Test Card** information. **Details 1 (800)-211-5635.**

BEST pricing on 18" satellite TV systems for home and RV. DSS, DISH Network programming, multi-room viewing options, accessories. Call **SKYVISION*** (800) 500-9264. www.skyvision.com

FREE Big Dish Catalog - Low prices - Systems, upgrades, parts and "4DTV". Call **SKYVISION*** (800) 334-6455. International (218) 739-5231. www.skyvision.com

SOUND for Videocypher-II and Plus without codes. Free details. **SASE. NASSIRIAN**, Box 382-P, Rio Linda, CA 95673.

DSS The real facts! Secret Hacker info. Easy to build Test/Card Programmers & more! \$14.95. **SPI**, Box 4748 Federal Way, WA 98063. 1 (800) 545-8435.

TEST EQUIPMENT

TEST Equipment pre-owned now at affordable prices. Signal generators from \$50.00, oscilloscopes from \$50.00. Other equipment including manuals available. Send \$2.00 US for catalog. Refunded on first order. **J.B. Electronics**, 3446 Dempster, Skokie, IL 60076. (847) 982-1973.

BATTERY Analyzer with PC Interface. DOS or Windows software \$279.00. **LA MANTIA PRODUCTS**, 1136 Aldersbrook Road, London, ON, N6G 2X8. (519) 472-5566 Fax: (519) 472-1702.

BUSINESS OPPORTUNITIES

INVENTIONS, ideas, new products! Presentation to industry/exhibition at national innovation exposition. Patent services. 1 (800) 288-IDEA.

LOOKING for extra income? Assemble products at home. Guaranteed! Call: 1 (800) 377-6000 Ext. 6870 Open Sunday.

I'M making a "bundle" reclaiming scrap gold from junk computers. Free info: 24 hrs, (603) 645-4767.

EASY work! Excellent pay! Assemble products at home. Call toll free 1(800) 467-5566 Ext. 5192.

EDUCATION & INSTRUCTION

LEARN electronics. Home study. Outstanding careers. Free literature. P.C.D.I., Atlanta, Georgia. 1 (800) 362-7070 Dept. ELG342.

MISCELLANEOUS ELECTRONICS FOR SALE

TUBES: "oldest", "latest". Parts and schematics. **SASE** for lists. **STEINMETZ**, 7519 Maplewood Ave., EN, Hammond, IN 46324.

FIBER-Optic Projects — Swing into the new technology by assembling tried and true projects recently published. "Practical Fiber-Optic Projects" - BP374 is only \$9.95. (price includes shipping) **ELECTRONIC TECHNOLOGY TODAY INC.**, PO Box 240, Massapequa Park, NY 11762-0240.

GREEN Thumb Alert— Electronics enters the Garden! New exciting book points out how gardeners can build simple gadgets to promote success where the elements work against you. Some of the projects are: over/under temperature monitoring, dusk/dawn switching, automatic plant watering, warming cables, etc. "Electronic Projects for the Garden" only \$9.95 (price includes shipping) **ELECTRONIC TECHNOLOGY TODAY INC.**, PO Box 240 Massapequa Park, NY 11762-0240.

RF Transistors, tubes 2SC1969, 2SC2166, MB8719, 2SC2312, 2SC2879, MRF477, MRF455, MRF454, MRF492, SRF3749, 4CX250B, 572B, 3-500, 6146B, 8975, WESTGATE 1 (800) 213-4563.

SOLAR cells 1001 uses! Crystal 4.2V, 240mA; 5 1/2" disk mounted, lexan cover. Used, tested, guaranteed excellent. 2 for \$20.00 ppd, 5 or more, \$9.00 ea. ppd. **C. LEMIEUX**, 1324 N. Liberty Lake Rd. #224E, Liberty Lake, WA 99019.

PLANS-KITS-SCHEMATICS

CRYSTAL set Handbook — Visit antiquity by building the radios your grandfather built. Assemble a "Quaker Oats" rig, wind coils that work and make it look like the 1920's! Only \$10.95 plus \$4.00 for shipping and handling. **CLAGGK INC.**, PO Box 4099, Farmingdale, NY 11735. US funds only! USA and Canada — no foreign orders.

FREE Catalog. 100 Leading-Edge kits. K1, P/C. Full instructions, source code. 1 (800) 875-3214. **SCIENCE FIRST**, 95 Botsford Place, Buffalo, NY 14216.

ELECTRONIC Project Kits. www.qkits.com 1-888-GO-4-KITS. 292 Queen St., Kingston, ON., K7K 1B8. **QUALITY KITS.**

CELLULAR Hackers Package. (3) Hacker Bibles, (2) Videos & Programming software. \$199.00 **VISA/MC. TELECODE** 1-520-726-2833. <http://www.hackerscatalog.com>

ALL-in-one catalog, 60 mouth-watering pages. CB/HAM/audio/TV/spy/broadcast/science projects, **mikropower broadcasting**, broadcast transmitters, amplifiers, antennas, "secret books", start your own radio station and more. Send \$1.00 to **PAN-COM INTERNATIONAL**, PO Box 130-N6, Paradise, CA 95967.

AWESOME Kits: Voice changers, levitators, lasers, gas sensors and more! Catalog \$1.00. **LNS TECHNOLOGIES**, 20993 Foothill Blvd., Suite 307R, Hayward, CA 94541. www.ccnnet.com/lnstech

BUILD five digit, resistance, capacitance, frequency multimeter. Instructions \$5.00, components \$39.95. **BAGNALL ELECTRONICS**, 179 May Street, Fairfield, CT 06432.

HACKERS software and information on everything else you want. Call **BOXCOM**, 1 (800) 345-7800.

BUY BONDS

CLASSIFIED

CABLE TV

TEST chips, test aids. All types, best products. Best prices. RFT-JTG-Terminator. Call 1 (800) 671-1110. E-mail (xient@hi.net)

CABLE Descrambling New secret manual. Build your own descramblers for cable and subscription TV. Instructions, schematics for S\$AVI, Gated Sync, Sinewave, (HBO, Cinemax, Showtime, UHF, Adult) \$12.95, \$2 postage. **CABLETRONICS**, Box 30502R, Bethesda, MD 20824.

CABLE TV Equipment & Accessories Wholesalers welcome! 30 day moneyback guarantee! Free catalog! **PERFORMANCE ELECTRONICS INC.**, 1 (800) 815-1512.

CABLE TV, descramblers, converters. Quantity discounts. 30 day free trial. Competitive prices. Call now! 1 (800) 322-0921 **REGAL SALES, INC.**

25+ **Master test chip files**. Jerrold, Scientific Atlanta, Tocom, Pioneer, Zenith. Software & book. \$79.95. TELECODE 1 (520) 726-2833. <http://www.hackerscatalog.com>

DESCRAMBLE cable with simple circuit added to Radio Shack RF modulator and using VCR as tuner, instructions \$10.00. **TELCOM**, Box 832-E6, Brusly, LA 70719.

ZENITH compatible test chips-activates full test mode. All except PZ1. \$24.95 **REALVIEW** (888) 732-5843 Visa/MC/Cod.

CABLE Descrambler!! Anyone can build in seven steps with Radio Shack parts. Plans/Kit from \$5.00 plus Free Bonus!! 1 (800) 818-9103.

DESCRAMBLE cable using simple circuit. E-Z to follow instructions and Complete universal kit with free "Bullet Stopper". \$20.00. 1 (800) 522-8053.

CABLE "Bullet Terminator and I.D. Blocker." Electronically shields yourself and your box. Also new Super Bullet/ID Eliminator!! Lifetime guarantee. 1 (800) 820-9024.

GIANT sale!!! Original equipment descramblers from \$149.00. Positive notch filter \$18.00. E-Z install cable test activation chips/boards for all models. "Magic Activator" External activator for all Dp(v), DPBB, CFT 2000/2200. Great features-restore locked box, multimode, hrc/standard much more. Dealers wanted. 1 (800) 449-9189 Anytime.

TEST chips. Provides full service mode. DP(V)5 & 7. DPBB7, CFT 2xx. BA-5000-6700. SA 8550-8600, Tocom 5503/07 VIP, Zenith ST 1000-5612. Call Anytime 1 (800) 449-9189.

CABLE TV descramblers. Pioneer 6310's, Scientific Atlanta, Jerrold. Warranty. Lowest prices anywhere. Houston, TX (713) 681-4610.

CABLE TV notch filters. Request our free brochure today! Voicemail: 1 (800) 433-6319. Address: **STAR CIRCUITS**, PO Box 94917, Las Vegas, NV 89193.

CABLE Descramblers - All major makes and models of original equipment, aftermarket replacements, and accessories. Quantity discounts and dealer pricing available. Call **CABLE CONNECTION** toll free at 1-888-83-CABLE or e-mail info to cable@midusa.net

WHOLESALE unmodified 5 lot Tocom VIP \$60.00, 5503A \$22.00, Zenith 1000, 1082 \$22.00. 1622 \$60.00. Jerrold DP5 Starcom \$50.00 DR2P 3A ID IN \$22.00. Oak RTC56 \$30.00. VISA. 1 (800) 500-9825.

DEALERS only, 5 lot Boss 2 piece all \$99.00. Tocom, Zenith, Oak. DR2P, DP5 \$99.00. VISA 1 (800) 219-8618.

MASTER files, test modules & cable boxes for all types of CATV converter units. (909) 941-4858.

ANNOUNCING external test unit for Zenith ST5612 Cableboxes. Automatically reprograms descrambler upon blank screen detection. For USA distributor and free information pack write to: **LLAMATEK**, Hill House, Swanton Morley, Norfolk, NR20-4QB, Britain.

FREE cable descrambling plans. For details write: **SIERRA PUBLISHING**, 909 E. Yorba Linda Blvd., Suite H-181, Dept. ENF, Placentia, CA 92870.

CABLE test modules/cubes. Pioneers, S/A, Tocom, Jerrold. Latest technology. Quantity discounts. Call DCR: Tel: (718) 428-8515/624-8334. Fax: (718) 246-9731. Please no N.Y. calls.

SCRAMBLING NEWS

BEST satellite news source includes hacking information. Free catalog. www.scramblingnews.com. Voice/Fax (716) 283-6910.

**Yours for only
\$3.50
Prices includes
shipping!**



HAVE A THOUSAND YUCKS FOR ONLY THREE AND A HALF BUCKS! That comes to one-third of a cent per laugh. **Electronics Comics** is a compilation of over 125 riotous, outrageous and phenomenal cartoons that appeared in **Popular Electronics** and **Electronics Now**. Only \$3.50—price includes shipping. Clagggk, Inc., Reprint Bookstore, P.O. Box 4099, Farmingdale, NY 11735-0793. All payments in U.S. funds. Sorry, no orders outside U.S.A. and Canada. Check or money order only—send no cash. NY state residents add applicable tax. MA04

THE COLLECTED WORKS OF MOHAMMED ULLYES FIPS

#166—By Hugo Gernsback. Here is a collection of 21 April Fools Articles, reprinted from the pages of the magazines they appeared in, as a 74-page, 8 1/2 x 11-inch book. The stories were written between 1933 and 1964. Some of the devices actually exist today. Others are just around the corner. All are fun and almost possible. Stories include the Cordless Radio Iron, The Visi-Talkie, Electronic Razor, 30-Day LP Record, Teleyeglasses and even Electronic Brain Servicing. Get your copy today. Ask for book #166 and include \$16.00 (Includes shipping and handling) in the US and Canada, and order from **CLAGGK Inc.**, P.O. Box 4099, Farmingdale, NY 11735-0793. Payment in US funds by US bank check or International Money Order. Allow 6-8 weeks for delivery. MA05



Find Bad Capacitors

In-Circuit
with the
Capacitor Wizard



The Capacitor Wizard is an extremely **FAST** and **RELIABLE** device designed to measure ESR (Equivalent Series Resistance) on capacitors of 1uf and larger **"IN CIRCUIT"**, eliminating the need to remove the capacitor for accurate tests. The Capacitor Wizard finds **BAD** caps **IN CIRCUIT** that even **VERY EXPENSIVE** cap checkers **MISS ENTIRELY**, even out of the circuit!! Standard capacitor meters cannot detect any change in ESR therefore they miss bad capacitors leading to time consuming "Tough Dog" repairs. *Technicians say it is the most cost effective instrument on their workbench.*



Made in the USA
Order Today

Only \$179.95

Call 1-800-394-1984

<http://www.heinc.com>

30 day money back guarantee



ADVERTISING INDEX

Electronics Now does not assume any responsibility for errors that may appear in the index below.

Free Information Number	Page	Free Information Number	Page		
—	ABC Electronics	74	—	Learn	7
—	Aegis Research, Canada	86	—	M2L Electronics	113
—	AES	107	283	Mark V Electronics	93
214	All Electronics	73	284	MCM Electronics	77
—	All Phase Video Security	114	—	Meredith Instruments	110
—	Allison Technology	86	—	Merrimack Valley Systems	107
—	Allstar Electronics	100	128	MicroCode Engineering	CV3
—	AlphaLab	94	—	Micro Engineering Labs	105
—	AMC Sales	74	—	Modern Electronics	101
322	American Eagle Publications	92	285	Mouser Electronics	101
281	American Innovations	112	—	MWK	104
324	Basic Electrical Supply	90	258	New Sensor Corp.	76
325	Bel-Merit	113	—	NRI Schools	35
77	B&K Precision	CV2	71	NTE Electronics, Inc.	4
—	Bsoft Software, Inc.	107	336	Nu-Tek Electronics	87
329	C&S Sales, Inc.	88	262	Parts Express Inc.	75
—	Cable Discount	112	—	Polaris Industries	71
311	Capital Electronics	92	326	Prairie Digital	86
332	Circuit Specialists	82	264	Print (Pace)	109
—	Command Productions	96	266	Ramsey Electronics	103
226	Consumertronics	72	—	R-4 Systems Inc.	96
328	CTG	94	—	RF Parts	90
—	Cybermation	96	323	Roger's Systems Specialist	95
—	DC Electronics	57	—	Sil Walker	110
133	Digi-Key Corp.	5	270	Skyvision Inc.	81
—	EDE - Spy Outlet	100	—	Square 1 Electronics	111
—	Electronic Goldmine	85	—	Starlet Systems	100
320	Electronix Express	102	—	Street Smart Security	104
—	Electronics Tech Today	13, 25	327	Sun Equipment	91
—	Emac Inc.	90	—	Tab Books	16
335	Flex Electronics	74	—	TC Instruments	101
321	Foley-Belsaw Co.	97	—	TECHMART	100
334	Fotronic	102	—	Technical Serv. & Solutions	112
—	General Device Instruments	105	—	Tektronix, Inc.	11, 29
122	Global Specialties	21	331	Telulex	102
—	Grantham Col. of Engineering	9	—	Test Equipment Sales	104
—	Home Automation	107	275	Timeline	80
333	Howard Electronics	79	—	U.S. Cyberlab	106
—	Howard Electronics	115	—	Visual Communications	24
—	Information Unlimited	78	98	Wavetek Corp.	23
126	Interactive Image Technologies	CV4	319	Weka Publishing	98
316	IVEX Design International	105	318	White Star Electronics	92
—	Jameco	3	—	WPT Publications	94
—	James Electronics	101	280	Xandi Electronics	111
282	Jensen Tools	71			

ADVERTISING SALES OFFICES

Gernsback Publications, Inc.
500 Bi-County Blvd.
Farmingdale, NY 11735-3931
1-(516) 293-3000
Fax 1-(516) 293-3115

Larry Steckler
 publisher (ext. 201)
 e-mail advertising@gernsback.com

Christina Estrada
 assistant to the publisher (ext. 209)

Arline Fishman
 advertising director (ext. 206)

Michele Torrillo
 advertising assistant (ext. 211)

Adria Coren
 credit manager (ext. 208)

For Advertising ONLY

EAST/SOUTHEAST

Stanley Levitan
 Eastern Advertising
 1 Overlook Ave.
 Great Neck, NY 11021-3750
 1-516-487-9357
 Fax 1-516-487-8402
slevitan26@aol.com

MIDWEST/Texas/Arkansas/Okla.

Ralph Bergen
 Midwest Advertising
 One Northfield Plaza, Suite 300
 Northfield, IL 60093-1214
 1-847-559-0555
 Fax 1-847-559-0562
bergenrj@aol.com

PACIFIC COAST

Janice Coast
 Pacific Advertising
 Hutch Looney & Associates, Inc.
 6310 San Vicente Blvd.
 Suite 360
 Los Angeles, CA 90048-5426
 1-213-931-3444 (ext. 228)
 Fax 1-213-931-7309

Electronic Shopper

Joe Shere
 National Representative
 P.O. Box 169
 Idyllwild, CA 92549-0169
 1-909-659-9743
 Fax 1-909-659-2469

Megan Mitchell

National Representative
 9072 Lawton Pine Avenue
 Las Vegas, NV 89129
 Phone/Fax 702-240-0184
Lorri88@aol.com

Customer Service

1-800-999-7139
 7:00 AM - 6:00 PM M-F MST

The **Only** Complete Virtual Electronics Lab™

CircuitMaker 5

**The Fastest, Most Accurate,
True Mixed-Signal SPICE Simulator**

CircuitMaker is a virtual electronics lab where you can quickly and easily design and verify digital, analog and true mixed-mode circuits. You layout your circuit design as a schematic, connecting an assortment of over 4000 indestructible components. Click on the simulation button and view the results as if you were looking at real laboratory instruments. It really is that easy!

New users love CircuitMaker's user friendly environment and short learning curve. Experienced users appreciate its time saving features and respect its accurate simulation and numerous in-depth analysis capabilities. No matter what level of electronics you are at, CircuitMaker, The Virtual Electronics Lab, will match your needs. We are so confident you will love its performance that we back every copy with our iron clad satisfaction guarantee!

TraxMaker 2

**The Most Affordable,
Professional Quality, PCB Design Tool**

TraxMaker is a Printed Circuit Board (PCB) layout program with advanced features such as a built-in autorouter, 8 layer capability, support for surface mount devices, and full design rule checking. Most importantly, TraxMaker provides these features while remaining exceptionally easy to use.

TraxMaker is a truly cost effective package which is sure to handle your most demanding PCB design tasks. TraxMaker can be used as a stand-alone product or with compatible schematic capture products. When used in conjunction with CircuitMaker, TraxMaker completes a powerful start to finish circuit design system. TraxMaker provides more power than any other product in its class!

CircuitMaker CBT
**Electronics Training Featuring
An Award Winning Curriculum**

MicroCode Engineering and Lab-Volt Systems present CircuitMaker CBT comprising 28 analog and digital lessons organized into four modules covering DC Concepts, AC Concepts, Analog Device Concepts and Digital Device Concepts. This is not another one of those "textbooks on a computer", rather it is an interactive presentation in an intuitive multimedia CD ROM format providing over 200 virtual labs simulated in CircuitMaker.

The award winning curriculum provides the most powerful teaching/learning tool for electronics available today. This complete electronics program includes on-line instruction and testing, workbooks, and virtual labs. Best of all, you do not have to purchase any expensive laboratory equipment to have an exciting and accurate electronics training program. CircuitMaker CBT will help the user learn and understand electronics and troubleshooting of both analog and digital circuits. We guarantee it!

CircuitMaker - \$299 TraxMaker - \$299
CircuitMaker CBT - \$75 per module

**Call now to order or
request additional information
800-419-4242**

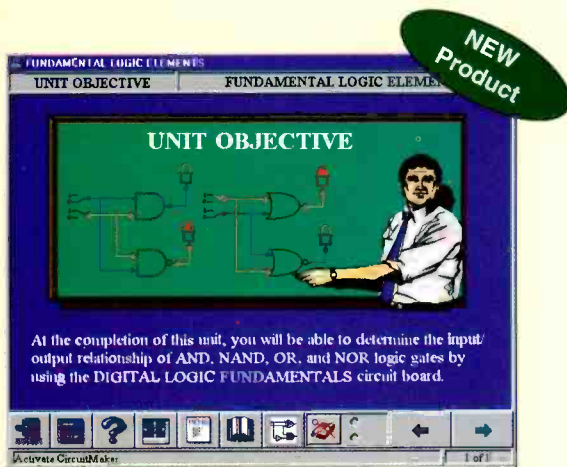
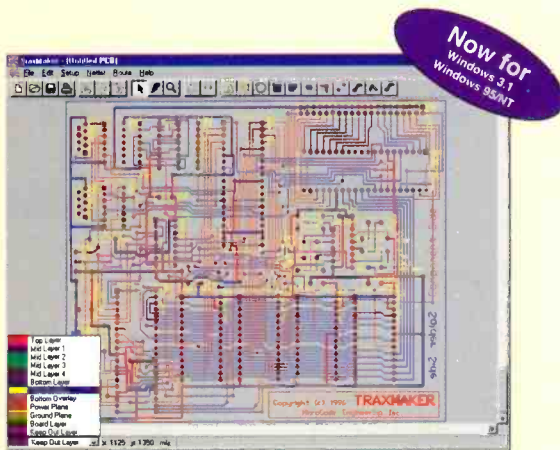

Total Customer Satisfaction

At MicroCode Engineering we are committed to total customer satisfaction. When you purchase one of our products you have the confidence of knowing that a trained staff of professionals is available to serve you after the sale. Our free unlimited customer service is second to none! Whether you have general or technical questions they will be answered promptly by a knowledgeable representative.

FREE Functional Demo

Additional literature and free functional demos of our products are available on the Internet at <http://www.microcode.com> and on CompuServe (GO MICROCODE).

Better Designs -Faster

\$299

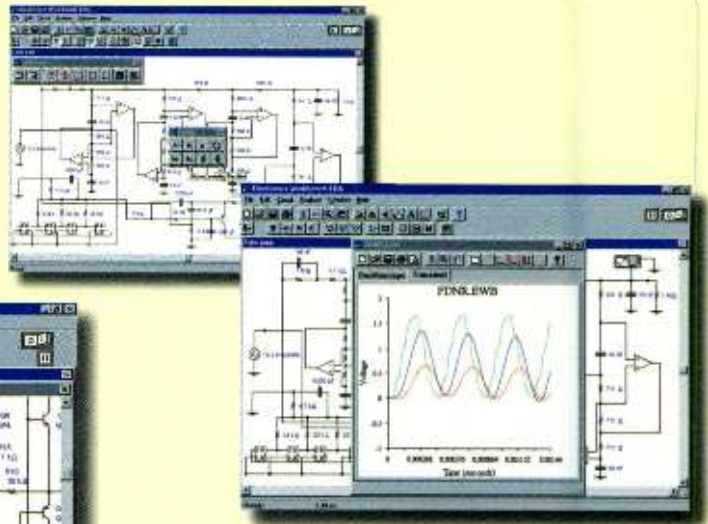
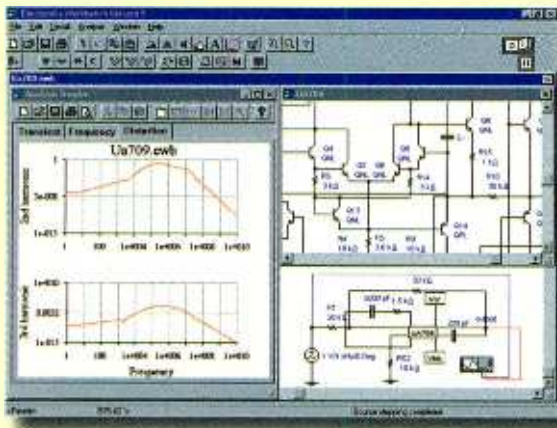

NEW!

Electronics Workbench Version 5 with analog, digital and mixed A/D SPICE simulation, a full suite of analyses and over 4,000 devices. Still the standard for power and ease of use. Now ten times faster. Still the same low price.

Join over 75,000 customers and find out why more engineers and hobbyists buy Electronics Workbench than any other SPICE simulator. You'll be working productively in 20 minutes, and creating better designs faster. We guarantee it!

For a free demo, check out our web site at <http://www.interactiv.com>

30-DAY MONEY-BACK GUARANTEE
VERSION 5.0 FOR WINDOWS 95/NT/3.1. Upgrades from previous versions \$79.

CALL 800-263-5552



Fax: 416-977-1818 Internet: <http://www.interactiv.com> CompuServe: 71333,3435/BBS: 416-977-3540/E-mail: ewb@interactiv.com

CIRCLE 126 ON FREE INFORMATION CARD

High-End Features

TRUE MIXED ANALOG/DIGITAL	YES
FULLY INTERACTIVE SIMULATION	YES
ANALOG ENGINE	SPICE 3F5, 32-BIT
DIGITAL ENGINE	NATIVE, 32-BIT
TEMPERATURE CONTROL	EACH DEVICE
PRO SCHEMATIC EDITOR	YES
HIERARCHICAL CIRCUITS	YES
VIRTUAL INSTRUMENTS	YES
ON-SCREEN GRAPHS	YES
ANALOG COMPONENTS	OVER 100
DIGITAL COMPONENTS	OVER 200
DEVICE MODELS	OVER 4,000
MONEY-BACK GUARANTEE	30-DAY
TECHNICAL SUPPORT	FREE

Powerful Analyses

DC OPERATING POINT	YES
AC FREQUENCY	YES
TRANSIENT	YES
FOURIER	YES
NOISE	YES
DISTORTION	YES

Electronics Workbench[®]

VERSION 5

INTERACTIVE IMAGE TECHNOLOGIES LTD., 908 Niagara Falls Boulevard, #068, North Tonawanda, New York 14120-2060/ Telephone 416-977-5550

TRADEMARKS ARE PROPERTY OF THEIR RESPECTIVE HOLDERS. OFFER IS IN U.S. DOLLARS AND VALID ONLY IN THE UNITED STATES AND CANADA. ALL ORDERS SUBJECT TO \$15 SHIPPING AND HANDLING CHARGE